



Agilent VnmrJ 4

Experiment Guide



Agilent Technologies

Notices

© Agilent Technologies, Inc. 2013

No part of this manual may be reproduced in any form or by any means (including electronic storage and retrieval or translation into a foreign language) without prior agreement and written consent from Agilent Technologies, Inc. as governed by United States and international copyright laws.

Manual Part Number

G7446-90515

Edition

Revision A, March 2013

This guide is valid for 4.0 and later revisions of the Agilent VnmrJ software, until superseded.

Agilent Technologies, Inc.
5301 Stevens Creek Blvd.
Santa Clara, CA 95051

Warranty

The material contained in this document is provided “as is,” and is subject to being changed, without notice, in future editions. Further, to the maximum extent permitted by applicable law, Agilent disclaims all warranties, either express or implied, with regard to this manual and any information contained herein, including but not limited to the implied warranties of merchantability and fitness for a particular purpose. Agilent shall not be liable for errors or for incidental or consequential damages in connection with the furnishing, use, or performance of this document or of any information contained herein. Should Agilent and the user have a separate written agreement with warranty terms covering the material in this document that conflict with these terms, the warranty terms in the separate agreement shall control.

Technology Licenses

The hardware and/or software described in this document are furnished under a license and may be used or copied only in accordance with the terms of such license.

Restricted Rights Legend

U.S. Government Restricted Rights. Software and technical data rights granted to the federal government include only those rights customarily provided to end user customers. Agilent provides this customary commercial license in Software and technical data pursuant to FAR 12.211 (Technical Data) and 12.212 (Computer Software) and, for the Department of Defense, DFARS 252.227-7015 (Technical Data - Commercial Items) and DFARS 227.7202-3 (Rights in Commercial Computer Software or Computer Software Documentation).

Safety Notices

CAUTION

A **CAUTION** notice denotes a hazard. It calls attention to an operating procedure, practice, or the like that, if not correctly performed or adhered to, could result in damage to the product or loss of important data. Do not proceed beyond a **CAUTION** notice until the indicated conditions are fully understood and met.

WARNING

A **WARNING** notice denotes a hazard. It calls attention to an operating procedure, practice, or the like that, if not correctly performed or adhered to, could result in personal injury or death. Do not proceed beyond a **WARNING** notice until the indicated conditions are fully understood and met.

In This Guide...

This guide provides more information about the small-molecule liquids experiments available in the Agilent VnmrJ 4 Experiment Selector.

Contents

1	Introduction to Experiments	19
	Organization	20
	Modular Experiment Setup	22
2	Standard 1D - Std 1D	25
	STD 1D Tab	26
	PROTON	28
	General description and usage	28
	Key parameters	29
	Processing	30
	Tips, tricks, and next steps	30
	CARBON	32
	General description and usage	32
	Key parameters	33
	Processing	34
	Tips, tricks, and next steps	34
	FLUORINE	36
	General description and usage	36
	Key parameters	37
	Processing	38
	Tips, tricks, and next steps	38
	PHOSPHORUS	40
	General description and usage	40
	Key parameters	41
	Processing	42
	Tips, tricks, and next steps	42
	(H)PRESAT	44
	General description and usage	44

Contents

Key parameters	45
Processing	46
Tips, tricks, and next steps	46
(H)wet1D	50
General description and usage	50
Key parameters	51
Processing	52
Tips, tricks, and next steps	52
T1_MEASURE	56
General description and usage	56
Key parameters	57
Processing	58
Tips, tricks, and next steps	58
T2_MEASURE	60
General description and usage	60
Key parameters	61
Processing	62
Tips, tricks, and next steps	62
(C)APT	64
General description and usage	64
Key parameters	65
Processing	66
Tips, tricks, and next steps	66
(C)DEPT	68
General description and usage	68
Key parameters	69
Processing	70
Tips, tricks, and next steps	70
PureShift 1D	72
General description and usage	72

Key parameters	73
Processing	74
Tips, tricks, and next steps	74
(H)HomoDec	76
General description and usage	76
Key parameters	77
Processing	78
Tips, tricks, and next steps	78
CARBONecho	80
General description and usage	80
Key parameters	81
Processing	82
Tips, tricks, and next steps	82
BilevelDec	84
General description and usage	84
Key parameters	85
Processing	86
Tips, tricks, and next steps	86
3 Homonuclear 2D - (HH)Homo2D	89
(HH)Homo2D Tab	90
gCOSY	92
General description and usage	92
Key parameters	93
Processing	94
Tips, tricks, and next steps	94
COSY	96
General description and usage	96
Key parameters	97
Processing	98
Tips, tricks, and next steps	98

gDQCOSY	100
General description and usage	100
Key parameters	101
Processing	102
Tips, tricks, and next steps	102
DQCOSY	104
General description and usage	104
Key parameters	105
Processing	106
Tips, tricks, and next steps	106
TOCSY	108
General description and usage	108
Key parameters	109
Processing	110
Tips, tricks, and next steps	110
zTOCSY	112
General description and usage	112
Key parameters	113
Processing	114
Tips, tricks, and next steps	114
ROESY	116
General description and usage	116
Key parameters	117
Processing	118
Tips, tricks, and next steps	118
ROESYAD	120
General description and usage	120
Key parameters	121
Processing	122
Tips, tricks, and next steps	122

NOESY	124
General description and usage	124
Key parameters	125
Processing	126
Tips, tricks, and next steps	126
zCOSY	128
General description and usage	128
Key parameters	129
Processing	130
Tips, tricks, and next steps	130
4 Heteronuclear 2D 1-bond - J1(CH)corr	133
J1(CH)corr Tab	134
HSQCAD	136
General description and usage	136
Key parameters	137
Processing	138
Tips, tricks, and next steps	138
gHSQCAD	140
General description and usage	140
Key parameters	141
Processing	142
Tips, tricks, and next steps	142
HSQC	146
General description and usage	146
Key parameters	147
Processing	148
Tips, tricks, and next steps	148
gHSQC	150
General description and usage	150
Key parameters	151

Processing	152
Tips, tricks, and next steps	152
HMQC	154
General description and usage	154
Key parameters	155
Processing	156
Tips, tricks, and next steps	156
gHMQC	158
General description and usage	158
Key parameters	159
Processing	160
Tips, tricks, and next steps	160
HETCOR	162
General description and usage	162
Key parameters	163
Processing	164
Tips, tricks, and next steps	164
gHETCOR	166
General description and usage	166
Key parameters	167
Processing	168
Tips, tricks, and next steps	168
ASAPHMQC	170
General description and usage	170
Key parameters	171
Processing	172
Tips, tricks, and next steps	172
5 Heteronuclear 2D multiple-bond - Jn(CH)corr	175
Jn(CH)corr Tab	176

gHMBCAD	178
General description and usage	178
Key parameters	179
Processing	180
Tips, tricks, and next steps	180
gHMBC	182
General description and usage	182
Key parameters	183
Processing	184
Tips, tricks, and next steps	184
gH2BCAD	186
General description and usage	186
Key parameters	187
Processing	188
Tips, tricks, and next steps	188
gH2BC	190
General description and usage	190
Key parameters	191
Processing	192
Tips, tricks, and next steps	192
CIGAR	194
General description and usage	194
Key parameters	195
Processing	196
Tips, tricks, and next steps	196
CIGARAD	198
General description and usage	198
Key parameters	199
Processing	200
Tips, tricks, and next steps	200

HMBC	202
General description and usage	202
Key parameters	203
Processing	204
Tips, tricks, and next steps	204
gHMBCmeAD	206
General description and usage	206
Key parameters	207
Processing	208
Tips, tricks, and next steps	208
gHMBCRELAY	212
General description and usage	212
Key parameters	213
Processing	214
Tips, tricks, and next steps	214
6 Selective 1D - (H)Sel1D	217
(H)Sel1D Tab	218
NOESY1D	220
General description and usage	220
Key parameters	221
Processing	222
Tips, tricks, and next steps	222
ROESY1D	226
General description and usage	226
Key parameters	227
Processing	228
Tips, tricks, and next steps	228
TOCSY1D	232
General description and usage	232
Key parameters	233

Processing	234
Tips, tricks, and next steps	234
zTOCSY1D	236
General description and usage	236
Key parameters	237
Processing	238
Tips, tricks, and next steps	238
selexcit	240
General description and usage	240
Key parameters	241
Processing	241
Tips, tricks, and next steps	242
stepNOESY1D	244
General description and usage	244
Key parameters	245
Processing	246
Tips, tricks, and next steps	246
7 Selective 2D - Sel2D	249
Sel2D Tab	250
(HC)bsHSQCAD	252
General description and usage	252
Key parameters	253
Processing	254
Tips, tricks, and next steps	254
(HC)bsgHSQCAD	256
General description and usage	256
Key parameters	257
Processing	258
Tips, tricks, and next steps	258

(HC)bsgHMBC	260
General description and usage	260
Key parameters	261
Processing	262
Tips, tricks, and next steps	262
(HC)EXSIDE	264
General description and usage	264
Key parameters	265
Processing	266
Tips, tricks, and next steps	266
(HC)bsHSQCNOESY	268
General description and usage	268
Key parameters	269
Processing	270
Tips, tricks, and next steps	270
(HC)bsHSQCROESY	274
General description and usage	274
Key parameters	275
Processing	276
Tips, tricks, and next steps	276
(HH)bsROESY	280
General description and usage	280
Key parameters	281
Processing	282
Tips, tricks, and next steps	282
(HH)bsTOCSY	284
General description and usage	284
Key parameters	285
Processing	286
Tips, tricks, and next steps	286

(HH)bsNOESY	288
General description and usage	288
Key parameters	289
Processing	290
Tips, tricks, and next steps	290
8 Heteronuclear CRISIS2- (HC)Crisis2	293
(HC)Crisis2 Tab	294
c2hsqcse	296
General description and usage	296
Key parameters	297
Processing	298
Tips, tricks, and next steps	298
c2hsqc	300
General description and usage	300
Key parameters	301
Processing	302
Tips, tricks, and next steps	302
gc2h2bcme	304
General description and usage	304
Key parameters	305
Processing	306
Tips, tricks, and next steps	306
gc2h2bc	308
General description and usage	308
Key parameters	309
Processing	310
Tips, tricks, and next steps	310
gc2hmbcme	312
General description and usage	312
Key parameters	313

Processing	314
Tips, tricks, and next steps	315
gc2hmbc	318
General description and usage	318
Key parameters	319
Processing	320
Tips, tricks, and next steps	320
gc2hsqcse	322
General description and usage	322
Key parameters	323
Processing	324
Tips, tricks, and next steps	324
gc2hsqc	326
General description and usage	326
Key parameters	327
Processing	328
Tips, tricks, and next steps	328
9 Hetero-TOCSY - (HC)HetToxys	331
(HC)HetToxys Tab	332
HSQCADTOXY	334
General description and usage	334
Key parameters	335
Processing	336
Tips, tricks, and next steps	336
gHSQCADTOXY	340
General description and usage	340
Key parameters	341
Processing	342
Tips, tricks, and next steps	342

HSQCTOXY	346
General description and usage	346
Key parameters	347
Processing	348
Tips, tricks, and next steps	348
gHSQCTOXY	352
General description and usage	352
Key parameters	353
Processing	354
Tips, tricks, and next steps	354
HMQCTOXY	358
General description and usage	358
Key parameters	359
Processing	360
Tips, tricks, and next steps	360
gHMQCTOXY	364
General description and usage	364
Key parameters	365
Processing	366
Tips, tricks, and next steps	366
10 Carbon-carbon correlation - (CC)corr	369
(CC)corr Tab	370
INADEQUATE	372
General description and usage	372
Key parameters	373
Processing	374
Tips, tricks, and next steps	374
INADEQUATEAD	376
General description and usage	376
Key parameters	377

	Processing	378
	Tips, tricks, and next steps	378
	ADEQUATEAD	380
	General description and usage	380
	Key parameters	381
	Processing	382
	Tips, tricks, and next steps	382
11	Proton-fluorine - HF_Expts	385
	HF_Expts Tab	386
	FH_gHETCOR	388
	General description and usage	388
	Key parameters	389
	Processing	390
	Tips, tricks, and next steps	390
	FH_HOESY	392
	General description and usage	392
	Key parameters	393
	Processing	394
	Tips, tricks, and next steps	394
	FObs_HDec	396
	General description and usage	396
	Key parameters	397
	Processing	398
	Tips, tricks, and next steps	398
	HObs_FDec	400
	General description and usage	400
	Key parameters	401
	Processing	402
	Tips, tricks, and next steps	402

12	JSpectra	405
	JSpectra Tab	406
	HETERO2DJ	408
	General description and usage	408
	Key parameters	409
	Processing	410
	Tips, tricks, and next steps	410
	HOMO2DJ	412
	General description and usage	412
	Key parameters	413
	Processing	414
	Tips, tricks, and next steps	414
13	Hadamard Encoded - Hadamard	417
	Hadamard Tab	418
	dqcosyHT	420
	General description and usage	420
	Key parameters	421
	Processing	422
	Tips, tricks, and next steps	422
	gcosyHT	424
	General description and usage	424
	Key parameters	425
	Processing	426
	Tips, tricks, and next steps	426
	hetcorHT	428
	General description and usage	428
	Key parameters	429
	Processing	430
	Tips, tricks, and next steps	430

hmbcHT	432
General description and usage	432
Key parameters	433
Processing	434
Tips, tricks, and next steps	434
hsqcHT	436
General description and usage	436
Key parameters	437
Processing	438
Tips, tricks, and next steps	438
hsqctocsyHT	440
General description and usage	440
Key parameters	441
Processing	442
Tips, tricks, and next steps	442
noesyHT	444
General description and usage	444
Key parameters	445
Processing	446
Tips, tricks, and next steps	446
roesyHT	450
General description and usage	450
Key parameters	451
Processing	452
Tips, tricks, and next steps	452
tocsyHT	454
General description and usage	454
Key parameters	455
Processing	456
Tips, tricks, and next steps	456

[Index](#) 459



1 Introduction to Experiments

Organization 20
Modular Experiment Setup 22

This guide was created for the benefit of organic chemist/novice NMR spectroscopists to intermediate level NMR spectroscopists.

The purpose of this document is to provide more information about the small-molecule liquids experiments available in the VnmrJ 4 Experiment Selector. Included are descriptions of the experiments, their utility, guides to parameter selection, processing, and references for further reading.



Organization

The chapters of this manual are divided into the headings listed on the tabs of the Experiment Selector found in the middle of the left side of the VnmrJ window:

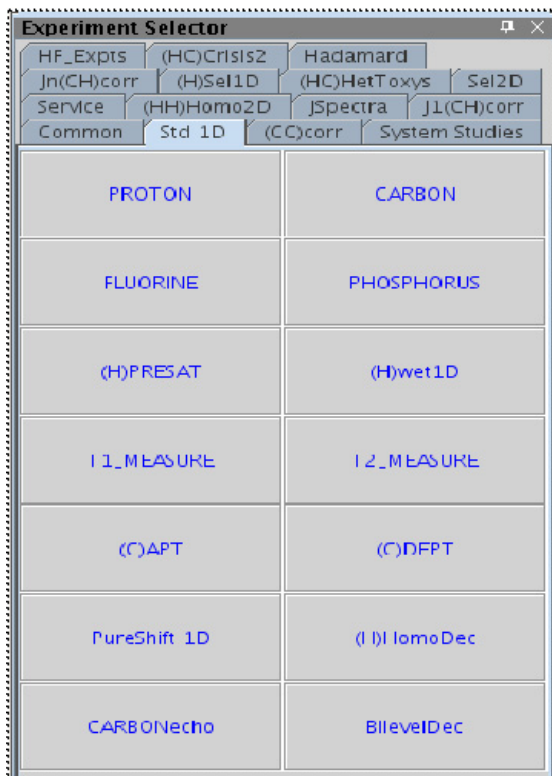

The DOSY2D and DOSY3D experiments are installed with the Dosey package for VnmrJ. If this package was purchased and/or installed, these tabs do appear. A separate DOSY manual is available under the “Help > Online Manuals” menu.

The “Common” tab is a redundant listing of popular routine experiments; similarly, the “System Studies” serve as demonstrations of experiments combined into a single study. Because these experiments are covered

under other tabs, these tabs have not been included. Finally, the “Service” tab is intended for the use of system service personnel, not the users of this manual, and was omitted.

The chapters begin with a general description of the family of experiments and some of the key variants among the experiments. Each experiment in the family is then discussed separately and in depth. The individual experiment descriptions contain a general overview, examples of usage, a pulse sequence diagram, guidance for parameters selection and processing, and literature references. A screenshot of the “Default” panel of the “Acquire” tab, which contains the most pertinent parameters, is shown for each experiment. Pictures of spectra from the experiments are not shown; however, example data sets for most experiments are located in the /vnmr/fidlib folder on your spectrometer.

Modular Experiment Setup

All the sequences in the Experiment Selector were built with a modular design to facilitate parameter setup. By using a “layering” approach where each experiment contributes some property to the final combination, it is possible to configure hundreds of variations without the need for hundreds of individual entries. Each experiment has a customized “Default” panel under the “Acquire” tab that contains the most important and commonly modified parameters for that experiment. Additional panels are added under the “Acquire” tab for more detailed parameters when necessary. When new experiments are created from existing ones, relevant parameters such as the spectral width are retained in a logical fashion.

To illustrate the modular concept, consider a progression of experiments starting with a PROTON and ending with an HSQCADTOXY. A PROTON experiment was acquired with a customized spectral width (sw). If an HSQC experiment is selected from the proton, this sw is maintained in the F2 dimension of the HSQC, as well as other acquisition dominant parameters such as the 90° pulse width (pw90). Set parameters related to the F1 dimension, for example, number of increments (ni) or the ¹³C spectral width. If you decide to acquire an HSQCAD instead, these new F1 parameters are transferred to the HSQCAD and you do not need to reset them. The necessary adiabatic shaped pulses are calculated automatically from parameters in the probe file. Then, to acquire an HSQCADTOXY from the HSQCAD experiment, set only the parameters relating to the TOCSY spinlock (for example, the mixing time). In contrast, if a TOCSY experiment is set up before the HSQCADTOXY, the parameters related to the TOCSY are transferred, and you must set up the HSQC-related parameters instead.

Solvent suppression is also much easier with this modular experiment design. Solvent suppression (“wet”, “presat”, or “purge” type) is available for nearly all the experiments in the selector. Separate experiments such as “presat COSY” or “wet TOCSY” are not necessary, which greatly simplifies the experiment choices. The desired type of solvent suppression is set by choosing the appropriate (H)PRESAT or (H)wet1D experiment and parameters (PURGE suppression is part of (H)PRESAT). Any experiment that is selected later automatically contains the same solvent suppression setup.

The focus of this manual is using the “Experiment Selector” buttons and the “Acquire” tab parameter panels to set up experiments. However, the “Experiments” pull-down menu at the top of the VnmrJ window contains some useful functionality for setting up experiments with nuclei other than the typical ^1H and/or ^{13}C . Briefly, selecting experiments under the “Convert Current Parameters To Do” heading retains the currently set transmitter nucleus (tn) and decoupler nucleus (dn). If the HSQCAD experiment is chosen with tn='F19'/dn='P31', the resulting parameters are for a ^{19}F - ^{31}P HSQCAD experiment. Similarly, if the PRESAT experiment is chosen with tn='F19' or 'P31', the result is a 1D ^{19}F or ^{31}P experiment with presaturation at a selected frequency. This menu allows for easy setup of experiments with “nonstandard” nuclei.

For all the pulse sequences, necessary shaped pulses are calculated automatically from a combination of parameters in the appropriate module and the probe file. Therefore, a probe file containing the relevant calibration information for the experiments is required. See the VnmrJ Installation and Administration manual, Chapter 9, for information on how to set up a probe file.

1 Introduction to Experiments

Modular Experiment Setup



2 Standard 1D - Std 1D

STD 1D Tab	26
PROTON	28
CARBON	32
FLUORINE	36
PHOSPHORUS	40
(H)PRESAT	44
(H)wet1D	50
T1_MEASURE	56
T2_MEASURE	60
(C)APT	64
(C)DEPT	68
PureShift 1D	72
(H)HomoDec	76
CARBONecho	80
BilevelDec	84



STD 1D Tab

This tab of the Experiment Selector includes the set of standard 1D experiments available, including experiments for proton and other nuclei. The experiments commonly used for proton detection include the standard PROTON 1D experiment, experiments with both presaturation and wet-type solvent suppression, T_1 and T_2 relaxation measurements, plus homonuclear and bilevel decoupling experiments as well as an experiment that produces the equivalent of a broad-band decoupled proton spectrum, called Pureshift 1D. Carbon-detected experiments included are the basic CARBON, (C)APT and (C)DEPT multiplicity selection, and a CARBONecho experiment. Finally, there are tabs for ^{19}F (FLUORINE) and ^{31}P (PHOSPHORUS) 1D experiments, which are also easily adapted for other X-nuclei.

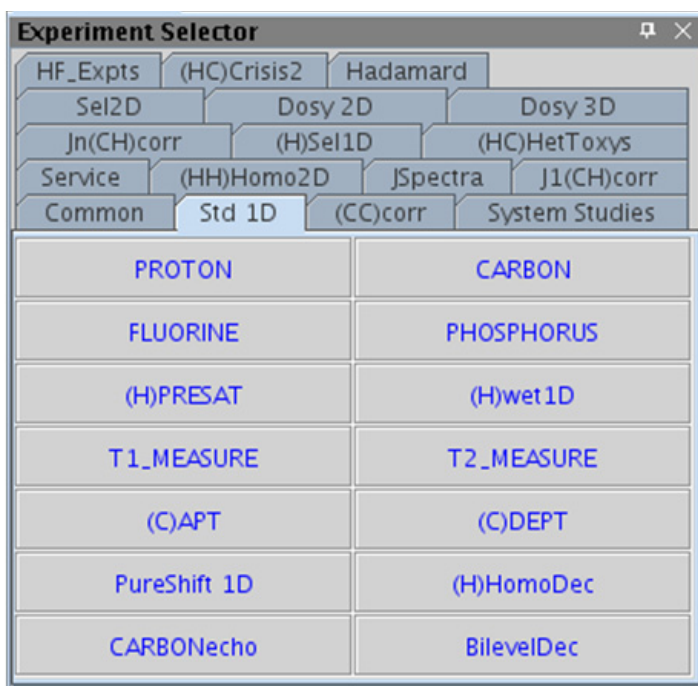

PROTON

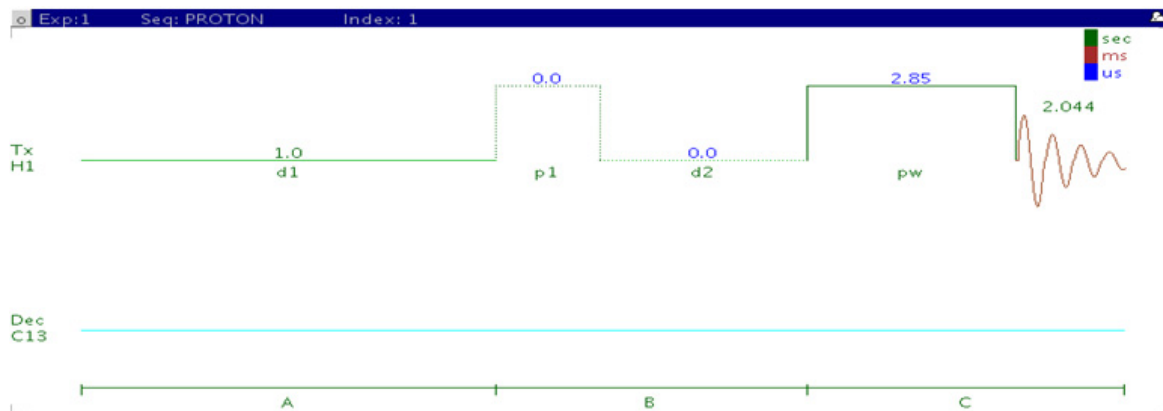

General description and usage

Description:

Uses the standard s2pul pulse sequence to acquire a 1D-¹H dataset.

Usage:

Just as the PROTON experiment is the first step in a typical small molecule structure elucidation, it is also the basic building block for most of the common liquids NMR experiments. When acquiring under automation, most of the 2D experiments require acquisition of a 1D proton first, and it is helpful to begin with this experiment when acquiring manually as well. Important parameters such as solvent and spectral width are transferred to further experiments set up from the proton dataset. All parameters are set from the “Acquire” tab/”Default H1” panel unless otherwise specified.

Key parameters

Parameter	Description
Solvent (solvent)	Set from "Start" tab/"Standard" panel
Spectral Width (sw)	Select typical choices from pull down menu or type in specific ppm values
Number of scans (nt)	Select typical choices from pull down menu*
Relaxation Delay (d1)	Select typical choices from pull down menu*-controls the delay between scans
Pulse Angle	Select typical choices from pull down menu*-controls the tip angle for the pulse
Acquisition time (at)	Set from "Pulse Sequence" panel, controls the digital resolution (Hz/point, 1/at)

NOTE

You can type specific values for these parameters manually in the appropriate boxes on the "Acquisition" panel.

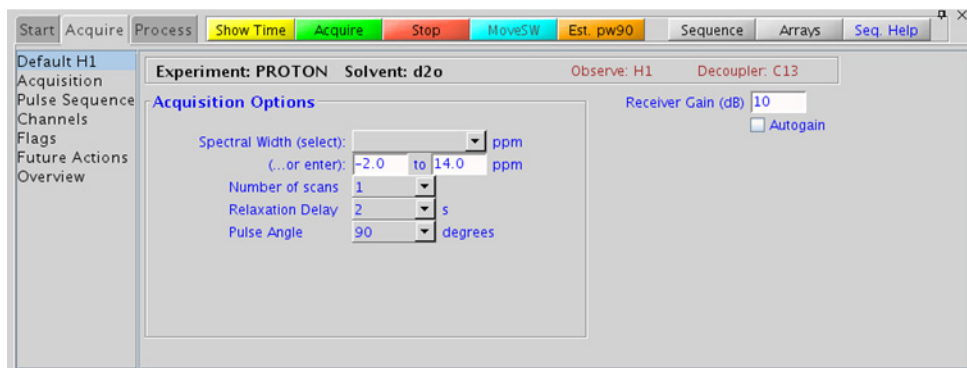



Processing

A typical processing weighting (apodization) choice that provides S/N enhancement (at the expense of resolution) for a 1D proton spectrum is line broadening, with an lb setting from $\sim 0.5 - 1$ Hz. A suggested optimal value is an lb equal to the unfiltered peak linewidth at half-height. Other types of weighting functions are available under the “Process” tab on the “Weighting” panel. Suggested choices for resolution enhancement (at the expense of S/N) are “pseudo echo” and “res-enhance.” When the weighting function is selected, values for these parameters are calculated based on the acquisition time. They can also be set manually with the “Interactive Weighting” button.

NOTE

Resolution enhancing functions affect the spectral integration- do not use these types of apodization for quantification.

Tips, tricks, and next steps

- The appropriate receiver gain (gain) is most easily set by making sure that the Autogain option is checked on the right side of the “Acquire” tab. The software optimizes the gain setting before data collection.
- To optimize the spectral width (sw) further, place one cursor on each side of the desired region on the spectrum, click the  button located under the spectrum window and reacquire the data.
- To estimate the 90° pulse automatically for subsequent experiments, click the  button located underneath the spectrum window. This calibration is used in lieu of the value in the probe file for future experiments on this sample. Calibration is useful with either salty samples or where perfect tuning is not achievable, both of which can cause longer 90° pulse values.
- The acquisition time (at) which controls the digital resolution (Hz/point, which is equal to $1/at$), is set on the “Acquisition” panel of the “Acquire” tab. While the default digital resolution set from the chosen spectral width is typically much greater than the actual linewidths, check that the acquisition time is sufficient when acquiring large spectral widths or when trying to measure linewidths accurately. For example, in probe lineshape tests.

- A pulse tip angle of 45° is common for PROTON experiments. Consider increasing to 90° for quantification. Decrease to smaller values (30° and less) in case of very concentrated samples to avoid receiver/ADC overflow.
- The *total* interscan delay is the sum of the acquisition time and the relaxation delay. When acquiring a multiscan PROTON experiment for quantification, set the interscan delay to at least 5X the longest proton T_1 value in the molecule (see the T1_MEASURE experiment to measure these values). Typical values for an interscan delay range from 3-5s (d1 of 1-3s with an acquisition time of ~ 2 s), which is not appropriate for quantification; consider using ~ 25 s if the T_1 values are not measured. For precise quantification ($<1\%$) a total relaxation delay of $10 \times T_1$ is appropriate.
- The PROTON dataset is used as a starting point for a wide range of experiments. Common next steps include setting up solvent suppression, choosing peaks for selective 1D experiments, and homo- and heteronuclear 2D experiments such as TOCSY and HSQC.

References:

R. J. Abraham, P. Loftus, Proton and Carbon-13 NMR Spectroscopy: An Integrated Approach, Heyden, London, 1978.

D. D. Traficante, Concepts Magn. Reson. 4 (1992) 153-160. (Quantitative Analysis)

CARBON

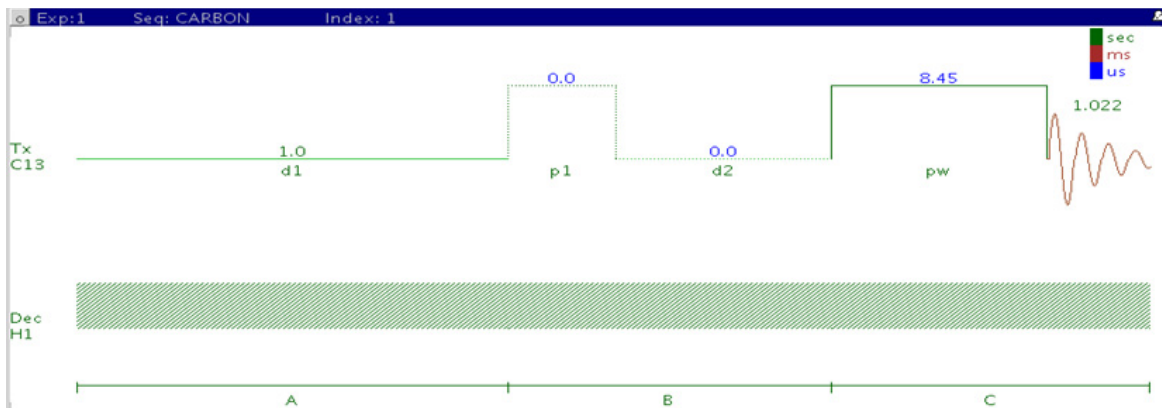

General description and usage

Description:

Uses the standard s2pul pulse sequence with decoupling to acquire a 1D- ^{13}C dataset.

Usage:

The 1D CARBON experiment is a tool commonly used by organic chemists for structure elucidation and confirmation as the carbon chemical shift is highly sensitive to nearby functional groups. Proton decoupling is traditionally used to simplify Carbon spectra to a series of single lines with little or no coupling constant information available. Carbon chemical shifts are also often reliably calculated from structural input by prediction software. The CARBON experiment, however, requires a relatively large amount of sample (or spectrometer time) as compared to proton-detected experiments due to the lower relative natural abundance of the ^{13}C nuclide and its reduced receptivity when compared to ^1H . All parameters are set from the “Acquire” tab/”Default C13” panel unless otherwise specified.

Key parameters

Parameter	Description
Solvent (solvent)	Set from "Start" tab/"Standard" panel
Spectral Width (sw)	Select typical choices from pull down menu or type in specific ppm values
Number of scans (nt)	Select typical choices from pull down menu*
Relaxation Delay (d1)	Select typical choices from pull down menu*-controls the delay between scans
Pulse Angle	Select typical choices from pull down menu*-controls the tip angle for the pulse
H1 decoupling (dm)	Select typical choices from pull down menu- turns decoupling and/or NOE enhancement on/off
Check S/N?	Select yes or no- acquires acquisition until S/N value between ppm indicated is > specified value
Acquisition time (at)	Set from "Pulse Sequence" panel, controls the digital resolution (Hz/point, 1/at)

NOTE

You can type specific values for these parameters manually in the appropriate boxes on the "Acquisition" panel.

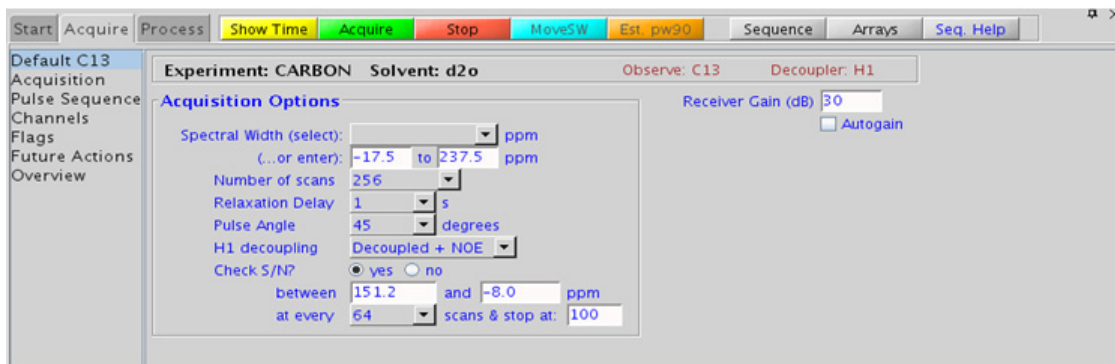

Processing

A typical processing weighting (apodization) choice that provides S/N enhancement (at the expense of resolution) for a 1D carbon spectrum is line broadening, with an lb setting from $\sim 0.5 - 1$ Hz. Carbon spectra is rarely of high enough S/N for resolution enhancement; however other types of weighting functions are available under the “Process” tab on the “Weighting” panel.

Tips, tricks, and next steps

- Receiver gain (gain) is usually set to a high value (≥ 30), unless the sample is extremely concentrated or ^{13}C -labelled.
- The acquisition time (at), which controls the digital resolution (Hz/point, which is equal to $1/\text{at}$), is set on the “Acquisition” panel of the “Acquire” tab. Because carbon spectra are often acquired with large spectral widths, the default digital resolution (set from the chosen spectral width) may be insufficient to see small coupling; consider lengthening the acquisition time and/or narrowing the spectral width when acquiring coupled carbon spectra.
- The standard proton-decoupled CARBON spectrum is produced by turning on the decoupling during the pulse and acquisition. It is also standard practice to leave the decoupler on during the preacquisition delay (d1), which provides an NOE enhancement to the carbon signals caused by the attached protons. Typically the more protons attached, the larger the enhancement. For example, methyl signals appear larger than quaternary carbon signals. Turn off the NOE enhancement if accurate quantification is desired.
- A common next step for structure elucidation after acquiring the CARBON data is to acquire a series of (C)DEPT experiments to determine the multiplicity of the carbon peaks (for example, methyl, methylene, and methine).
- Carbon T_2 relaxation times can be very long, particularly for quaternary and aromatic carbons, and for degassed samples such as the 10% ethylbenzene standard. Such samples can exhibit the symptom of being difficult or impossible to phase correctly if the spectra are truncated. Increase the acquisition time (at) until the phasing issue is corrected.

- If there is insufficient sample to obtain a CARBON spectrum, consider acquiring proton-detected experiments such as HSQC and HMBC, which give similar information and require much less sample. These experiments can also be configured to give multiplicity information.
- The CARBON dataset can be used as a starting point for carbon-detected correlation experiments such as INADEQUATE or HETCOR spectra. Optimized spectral widths are transferred to the 2D experiment.

References:

F. W. Wehrli, T. Wirthlin, Interpretation of Carbon-13 NMR Spectra, Heyden, London, 1976.

R. J. Abraham, P. Loftus, Proton and Carbon-13 NMR Spectroscopy: An Integrated Approach, Heyden, London, 1978.

E. Breitmaier, W. Voelter, Carbon-13 NMR Spectroscopy: High-Resolution Methods and Applications in Organic Chemistry and Biochemistry, VCH, 1987.

FLUORINE

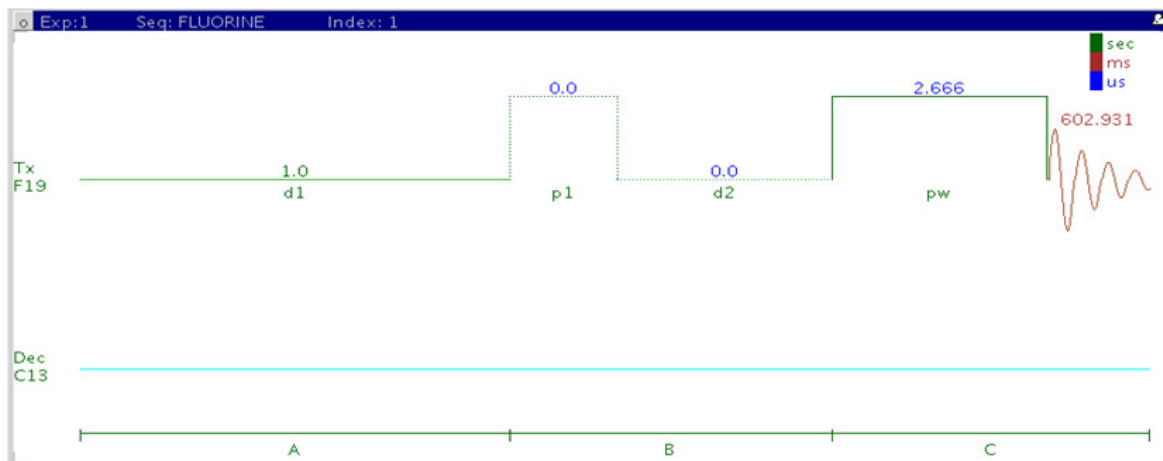

General description and usage

Description:

Uses the standard s2pul pulse sequence to acquire a 1D-¹⁹F dataset.

Usage:

The 1D FLUORINE experiment is typically used to confirm the presence of fluorine in a molecule. The large fluorine chemical shift range is highly sensitive to nearby functional groups. The experiment is nearly as sensitive as a 1D PROTON experiment. All parameters are set from the "Acquire" tab/"Default F19" panel unless otherwise specified.

Key parameters

Parameter	Description
Solvent (solvent)	Set from "Start" tab/"Standard" panel
Spectral Width (sw)	Type in specific ppm values
Number of scans (nt)	Select typical choices from pull down menu*
Relaxation Delay (d1)	Select typical choices from pull down menu*-controls the delay between scans
Pulse Angle	Select typical choices from pull down menu*-controls the tip angle for the pulse
Acquisition time (at)	Set from "Pulse Sequence" panel, controls the digital resolution (Hz/point, 1/at)

NOTE

You can type specific values for these parameters manually in the appropriate boxes on the "Acquisition" panel.

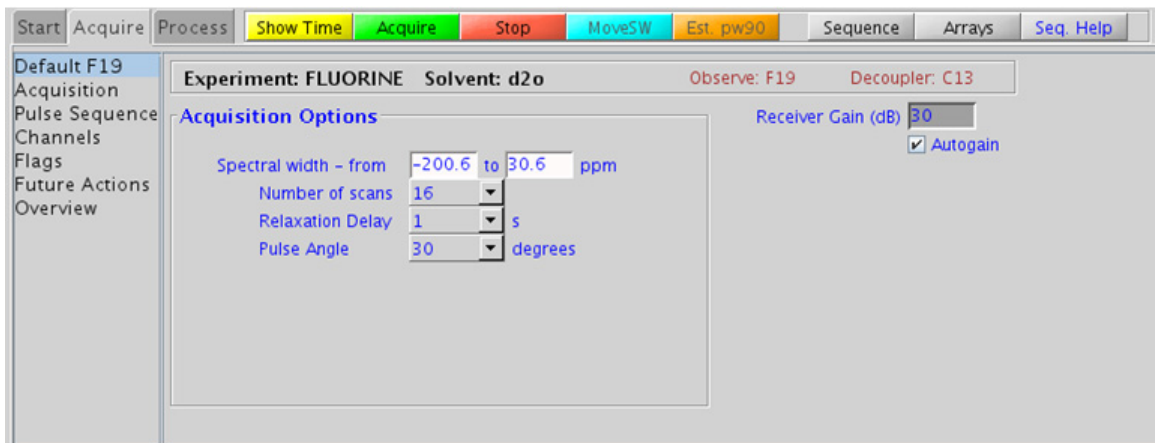

Processing

A typical processing weighting (apodization) choice that provides S/N enhancement (at the expense of resolution) for a 1D spectrum is line broadening, with an lb setting from $\sim 0.5 - 1$ Hz. A suggested optimal value is an lb equal to the unfiltered peak linewidth at half-height. Other types of weighting functions are available under the “Process” tab on the “Weighting” panel. Suggested choices for resolution enhancement (at the expense of S/N) are “pseudoecho” and “res-enhance.” When the weighting function is selected, values for these parameters are calculated based on the acquisition time. They can also be set manually with the “Interactive Weighting” button.

CAUTION

Resolution enhancing functions affect the spectral integration- do not use these types of apodization for quantification.

Many NMR probes contain fluorinated materials, which cause broad signals that can distort the baseline (especially when lying next to or outside the spectral window). The default processing parameters are set to use linear prediction to back predict the first seven points of the spectrum in order to flatten the baseline. These settings can be modified under the “Process” tab on the “More 1D” panel.

Tips, tricks, and next steps

- To optimize the spectral width (sw) further, place one cursor on each side of the desired region on the spectrum, click the  button located under the spectrum window and reacquire the data. The default range is set to cover the typical range of fluorine chemical shifts seen in organic molecules. As this range is large, once the fluorine signals are located, consider narrowing the chemical shift range and reacquiring the spectrum for better resolution.

- The acquisition time (*at*), which controls the digital resolution (Hz/point, which is equal to $1/at$), is set on the “Acquisition” page of the “Acquire” tab. Because FLUORINE spectra are often acquired with large spectral widths, the default digital resolution (set from the chosen spectral width) may be insufficient to see small couplings; consider lengthening the acquisition time and/or narrowing the spectral width.
- The *total* interscan delay is the sum of the acquisition time (*at*) and the relaxation delay (*d1*). When acquiring a multiscan FLUORINE experiment for quantification, set the interscan delay to at least 5X the longest fluorine T_1 value of the signals of interest.
- Because of the potentially wide spectral window, determination and use of 90° pulses with FLUORINE NMR experiments can be problematic. Measure the *pw90* with the transmitter offset (*tof*) positioned near an actual ^{19}F resonance.
- This fluorine experiment produces a proton-coupled ^{19}F spectrum. See the HF experiments (Chapter 11) for a proton-decoupled version of the experiment.
- When acquiring impure samples of fluorinated compounds from a biological origin, consider using fluorine spectra in lieu of a more complicated proton spectrum as appropriate.

References:

E. G. Brame, *Anal. Chem.* 34 (1962) 591-592. (Spectra Structure Correlations of F19)

E. F. Mooney, *An Introduction to ^{19}F NMR Spectroscopy*, Heyden, London, 1970.

S. Berger, S. Braun, H. O. Kalinowski, *NMR Spectroscopy of the Non-Metallic Elements*, Wiley, New York, (1997) 398-698.

J. Battiste, R. A. Newmark, *Prog. NMR. Spectrosc.* 48 (2006) 1-23. (Multidimensional ^{19}F NMR)

PHOSPHORUS

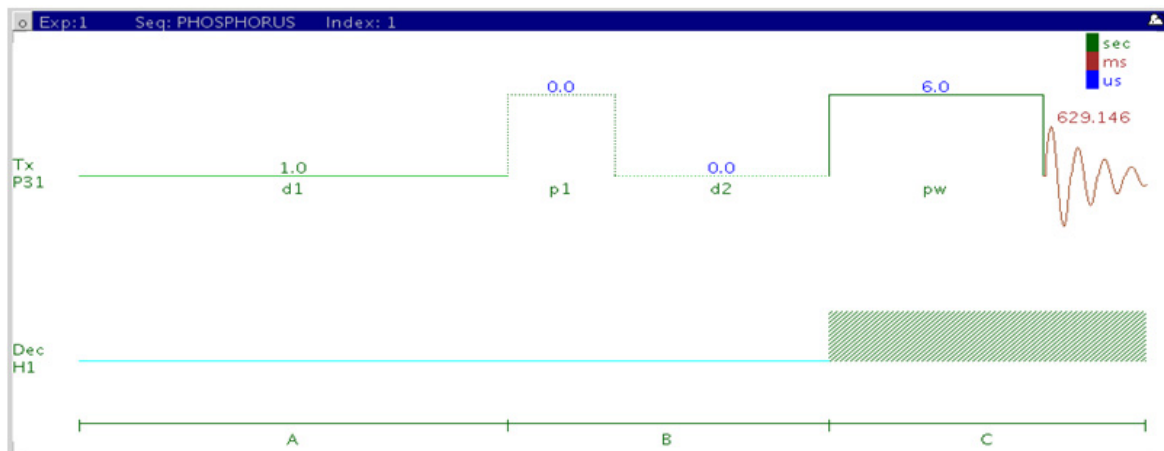

General description and usage

Description:

Uses the standard s2pul pulse sequence to acquire a 1D- ^{31}P dataset.

Usage:

The PHOSPHORUS experiment is typically used to confirm the presence of phosphorus in a molecule. The large phosphorus chemical shift range is highly sensitive to nearby functional groups and the oxidation state of the phosphorus atom. All parameters are set from the “Acquire” tab/”Default P31” panel unless otherwise specified.

Key parameters

Parameter	Description
Solvent (solvent)	Set from "Start" tab/"Standard" panel
Spectral Width (sw)	Type in specific ppm values
Number of scans (nt)	Select typical choices from pull down menu*
Relaxation Delay (d1)	Select typical choices from pull down menu*- controls the delay between scans
Pulse Angle	Select typical choices from pull down menu*- controls the tip angle for the pulse
H1 decoupling (dm)	Select typical choices from pull down menu- turns decoupling and/or NOE enhancement on/off
Check S/N?	Select yes or no- acquires acquisition until S/N value between ppm indicated is > specified value
Acquisition time (at)	Set from "Pulse Sequence" panel, controls the digital resolution (Hz/point, 1/at)

NOTE

You can type specific values for these parameters manually in the appropriate boxes on the "Acquisition" panel.

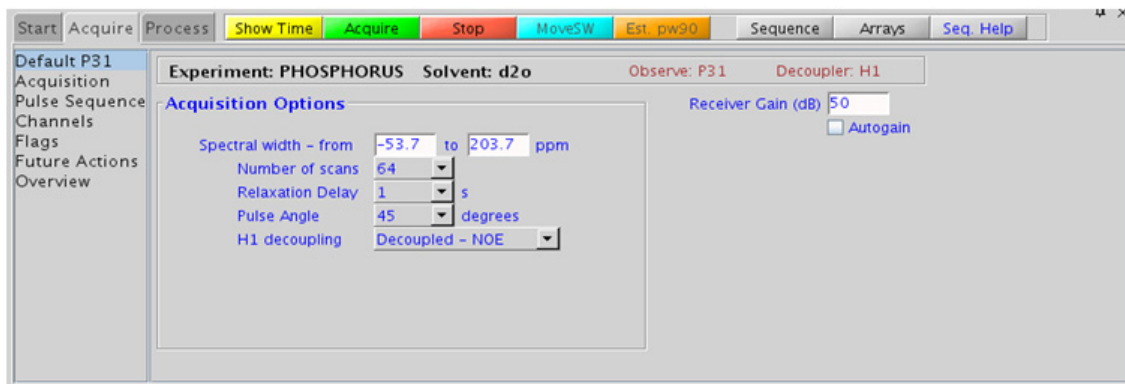

Processing

A typical processing weighting (apodization) choice that provides S/N enhancement (at the expense of resolution) for a 1D spectrum is line broadening, with an lb setting from $\sim 0.5 - 1$ Hz. Other types of weighting functions are available under the “Process” tab on the “Weighting” panel.

PHOSPHORUS spectra often contain broad signals, which distort the baseline. The default processing parameters are set to use linear prediction to back predict the first five points of the spectrum in order to flatten the baseline. These settings can be modified under the “Process” tab on the “More 1D” panel.

Tips, tricks, and next steps

- To optimize the spectral width (sw) further, place one cursor on each side of the desired region on the spectrum, click the  button located under the spectrum window and reacquire the data.
- The appropriate receiver gain (gain) is most easily set by making sure that the Autogain option is checked on the right side of the “Acquire” tab. The software optimizes the gain setting before data collection.
- The acquisition time (at), which controls the digital resolution (Hz/point, which is equal to $1/at$), is set on the “Acquisition” page of the “Acquire” tab. Because PHOSPHORUS spectra are often acquired with large spectral widths, the default digital resolution (set from the chosen spectral width) may be insufficient to see coupling; consider lengthening the acquisition time and/or narrowing the spectral width.
- If the sample was purified using reversed-phase HPLC, remember that many mobile phases commonly used in chromatography contain nonvolatile phosphate buffers. Such samples contain large background phosphorus signals from the buffer; consider using a different buffer such as formic acid when anticipating the need of ^{31}P NMR data.

- It is also possible to use presaturation to suppress a large, undesired peak in the phosphorus spectrum. From the PHOSPHORUS parameter set, go to the “Experiments” menu at the top of the VnmrJ window and choose “Convert current parameters to do... Solvent Suppression – Select Peaks => PRESAT submenu”. The “Default” panel now displays the appropriate parameters to configure the frequency/frequencies for suppression.

References:

- O. Khul, Phosphorous-31 NMR Spectroscopy, Springer (2008) 1-131.

(H)PRESAT

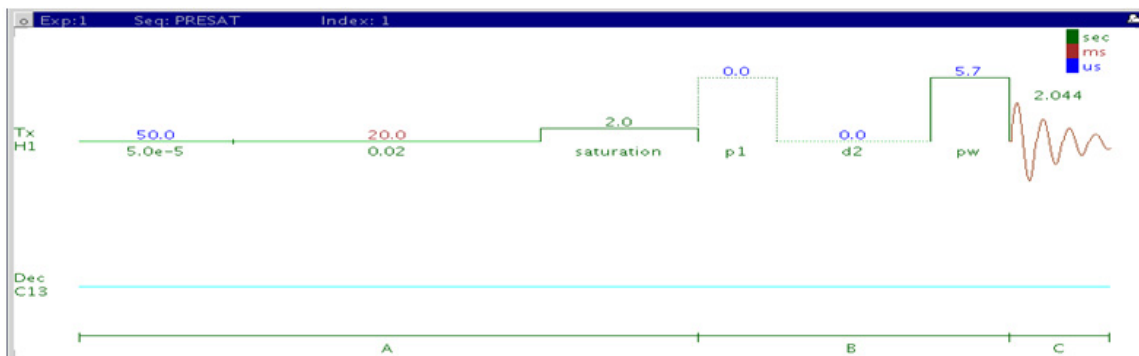

General description and usage

Description:

A standard s2pul pulse sequence to acquire a 1D-¹H dataset with a presaturation option to suppress strong signals. Single peaks are suppressed with a hard pulse, multiple peaks with a shaped pulse.

Usage:

Presaturation is a simple method of removing strong signals from a spectrum using irradiation during all or part of the relaxation delay. Common reasons for wanting to suppress signals include: (i) the presence of large solvent signals, (ii) use of nondeuterated solvents, like H₂O, (iii) use of samples with large background impurities or buffers such as urea or acetate, (iv) use of samples of low concentration when the residual proton signal from the deuterated solvent overwhelms the peaks of interest. The most straightforward method is to acquire a standard PROTON spectrum or a scout scan first and then interactively choose the peaks to suppress from this data. The software also allows the peaks to be chosen automatically via a threshold, or via a pull-down menu with several selections for water. These different setup methods are detailed in

the “Tips, tricks, and next steps” section. If additional experiments are set up from the (H)PRESAT data set, all the presaturation parameters are transferred to the new experiment. All parameters are set from the “Acquire” tab/”Default” panel unless otherwise specified.

Key parameters

Parameter	Description
Solvent (solvent)	Set from “Start” tab/”Standard” panel
Spectral Width (sw)	Type in specific ppm values (if using previously acquired proton data to select peaks for suppression, do not change)
Saturate? (satmode)	Choices of water type to suppress in pull-down, or check boxes to select later from scout scan, or type in specific water frequency, or suppression of n tallest peaks
Number of scans (nt)	Select typical choices from pull down menu*
Presaturation Delay (satdly)	Select typical choices from pull down menu*- controls the delay between scans
PURGE (prgflg)	Check box adds PURGE pulse to improve saturation, choose 2-step (default) or 4-step

NOTE

You can type specific values for these parameters manually in the appropriate boxes on the “Acquisition” panel.

2 Standard 1D - Std 1D Processing

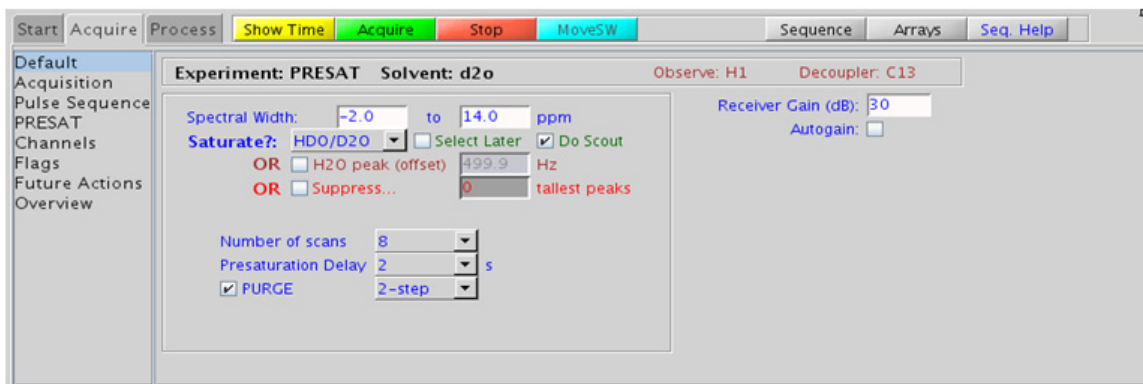

Processing

The processing is typically the same as processing used for standard PROTON spectrum, except manual phasing may be required due to an unphaseable residual signal from the suppressed peaks. A typical processing weighting (apodization) choice that provides S/N enhancement (at the expense of resolution) for a 1D spectrum is line broadening, with an lb setting from $\sim 0.5 - 1$ Hz. A suggested optimal value is line broadening equal to the unfiltered peak linewidth at half-height. Other types of weighting functions are available under the “Process” tab on the “Weighting” panel.

Tips, tricks, and next steps

- Choosing the (H)PRESAT experiment from a previously acquired PROTON data set allows for interactive selection of the peaks to be suppressed, and the “Default” panel appears differently. Choose single or multifrequency presat with the check boxes, place the cursors on or around the peak to be suppressed and click **Select**. The width of the peaks chosen determine the power used for the presaturation. Repeat for additional peaks.



If a PROTON spectrum has not been previously acquired but the “Select Later” and “Do Scout” options were checked on the “Default” panel shown in the “Key parameters” sections, the scout scan is acquired and the data displayed, now with the “Default” panel shown to facilitate the interactive peak selection.

- The appropriate receiver gain (gain) is most easily set by making sure that the Autogain option is checked on the right side of the “Acquire” tab. The software optimizes the gain setting before data collection. Selecting autogain is a good choice in most solvent suppression experiments acquired in automation.
- When you click the check box to “Suppress... n tallest peaks”, and type a value for n, a scout scan is acquired, and then the software sets up suppression on n peaks as measured from the threshold. This approach works well when acquiring in automation mode.
- The choices for water type in the “Saturate?” pull-down menu control the power of the RF field used for the presaturation. The highest power (50-Hz field) is used for the 90% H₂O, while the other choices (HDO/D₂O, wet DMSO) use lower power. The saturation frequency (satfrq) for the 90% H₂O suppression is automatically optimized for maximum efficiency.
- The power, length, and offset of the presat pulse can be modified manually in the “PRESAT” panel. Remember that presat powers are typically low (typically a small, negative number) and the length usually 2s or less. If additional interscan delay time is needed, the relaxation delay d1 can be set to a larger value than the presat delay.

2 Standard 1D - Std 1D

Tips, tricks, and next steps

- Adding the 2-step (or 4-step) purge option can significantly improve the presaturation efficiency, particularly for large water peaks. However the efficiency of the purge option is dependent upon the pw90 and B1 (in)homogeneity of the probe. The 4-step purge produces the best water suppression. Note, however, that the purge phase cycle is *added* to all subsequent experiments, for example, the minimum nt for 4-step PURGE is 4.
- Once the solvent suppression is set up satisfactorily, selecting another experiment type. For example, zTOCSY, NOESY, and so on, automatically retain suppression parameters for the new experiment. To turn off presaturation, unselect the “Presaturation” check box on the “PRESAT” panel.
- (H)PRESAT also suppresses any exchangeable protons. Use wet-type suppression to preserve these signals

References:

P. J. Hore, Methods Enzymol. 176 (1989) 64-77. (Solvent Suppression)

M. Gueron, P. Plateu, M. Decorps, Prog. NMR Spectrosc. 23 (1991) 135-209. (Solvent Signal Suppression)

R. T. MacKay, Ann. Rep. NMR. Spectrosc. 66 (2009) 33-76. (Advances in Solvent Suppression)

(H)wet1D

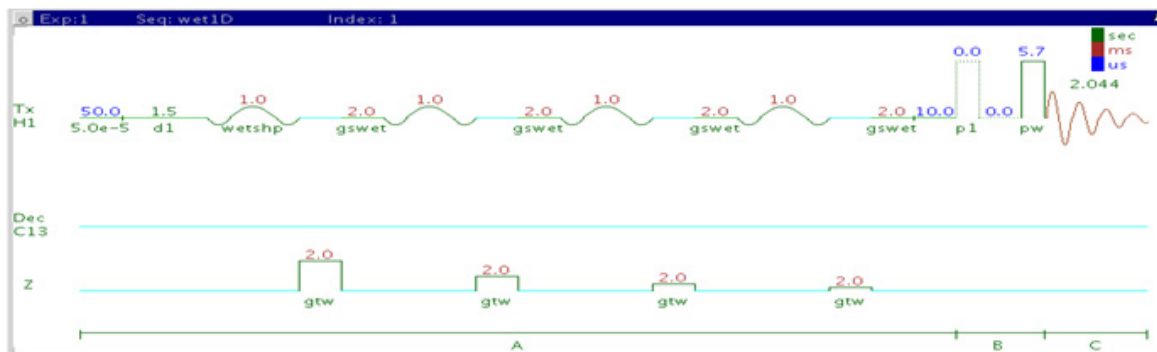

General description and usage

Description:

Pulse sequence to acquire a 1D-¹H dataset with selective excitation pulses to exclude strong signals.

Usage:

WET solvent suppression removes strong signals from a spectrum by creating a shaped pulse that excites only the solvent resonances followed by the use of gradients to suppress the excited resonances. WET suppression has the advantage over other methods (like (H)PRESAT) that the exchangeable protons are often not suppressed as much. It also facilitates the decoupling and hence removal of ¹³C satellites of organic solvents. However (H)wet1D does not result in the smallest residual H₂O signal, and it can also produce baseline artifacts that interfere somewhat with integration. Common reasons for wanting to suppress signals include: (i) the presence of large solvent signals, (ii) use of nondeuterated solvents, for example H₂O, (iii) use of samples with large background impurities or buffers, such as urea or acetate, or (iv) use of samples of low concentration when the residual proton signal from the deuterated solvent

overwhelms the peaks of interest. The most straightforward method is to acquire a standard PROTON spectrum or a scout scan first and from this data, interactively choose the peaks to be suppressed. The software also allows the peaks to be chosen automatically via a threshold or a number of common solvent selections. These different setup methods are detailed in the “Tips, tricks, and next steps” section. If additional experiments are set up from the (H)wet1D data set, all the presaturation parameters are transferred to the new experiment. All parameters are set from the “Acquire” tab/”Default” panel unless otherwise specified.

Key parameters

Parameter	Description
Solvent (solvent)	LSet from “Start” tab/”Standard” panel
Spectral Width (sw)	Type in specific ppm values (if using previously acquired proton data to select peaks for suppression, do not change)
WET peaks	Choices of define now (shows list of solvents when checked) or check boxes to select later from scout scan, or suppression of n tallest peaks, or type in specific water frequency
Number of scans (nt)	Select typical choices from pull down menu*
Relaxation Delay (d1)	Select typical choices from pull down menu*- controls the delay between scans
C13 decoupling during WET?	Turns decoupling on to suppress solvent ^{13}C satellites, for example, from CH_3CN
Optimize CF	Optimizes the compression factor for the transmitter power used for the wet shape

NOTE

You can type specific values for these parameters manually in the appropriate boxes on the “Acquisition” panel.

2 Standard 1D - Std 1D Processing



Processing

The processing is typically the same processing used for standard PROTON spectrum, except manual phasing may be required due to an unphaseable residual signal from the suppressed peaks. A typical processing weighting (apodization) choice that provides S/N enhancement (at the expense of resolution) for a 1D spectrum is line broadening, with an lb setting from $\sim 0.5 - 1$ Hz. A suggested optimal value is line broadening equal to the unfiltered peak linewidth at half-height. Other types of weighting functions are available under the “Process” tab on the “Weighting” panel.

Tips, tricks, and next steps

- Choosing the (H)wet1D experiment from a previously acquired PROTON data set allows for interactive selection of the peaks to be suppressed, and the “Default” panel appears differently (see the following figure). Choose single or multifrequency presat with the check boxes. Place the cursors on or around the peak to suppress and click **Select**. Repeat for additional peaks. A threshold can also be set to select peaks automatically.



If a PROTON spectrum has not been previously acquired but the “Select Later” and “Do Scout” options were checked on the “Default” panel shown in the “Key parameters” sections, the scout scan is acquired and the data displayed, now with the “Default” panel shown above to facilitate the interactive peak selection.

- The appropriate receiver gain (gain) is most easily set by making sure that the Autogain option is checked on the right side of the “Acquire” tab. The software optimizes the gain setting before data collection. Selecting autogain is a good choice in most solvent suppression experiments acquired in automation.
- When you click the check box to “Suppress... n tallest peaks”, and type a value for n, a scout scan is acquired, and then the software sets up suppression on n peaks as measured from the threshold. This approach works well when acquiring in automation mode.
- When selecting peaks for suppression via the solvent check boxes, note that the most common choices are displayed, while clicking the “more” button shows additional, less typical choices.
- Try to keep the widths of the selected peak >60 Hz, as peaks that are too narrow create long, shaped pulse durations.
- If the pw90 is reasonably accurate, the suppression quality using the default parameters is adequate for most samples. Click the “Optimize CF” check box to optimize suppression. This arrays and attempts to optimize a scaling factor for the shaped pulses tpwr_cf, looking for the value that produces the best suppression. If the desired number of scans is large (>32), this optimization takes a fair amount of time. Consider lowering nt for the optimization and then increasing after the parameters are set. This optimization can also be done manually from the “WET” panel.

2 Standard 1D - Std 1D

Tips, tricks, and next steps

- Once the solvent suppression is set up satisfactorily, selecting another experiment type. For example, zTOCSY, NOESY, and so on, automatically retain suppression parameters for the new experiment. To turn off WET, unselect the “WET” check box on the “WET” panel.

References:

R. Ogg, P. Kingsley, J. Taylor, J. Magn. Reson. B104 (1994) 1-10. (WET)

S. Smallcombe, S. L. Patt, P. Keifer, J. Magn. Reson. A117 (1995) 295-303.
(WET – Applications to LCNMR)

S. L. Patt, J. Magn. Reson. 96 (1992) 94-102. (Shifted Laminar Pulses)

T1_MEASURE

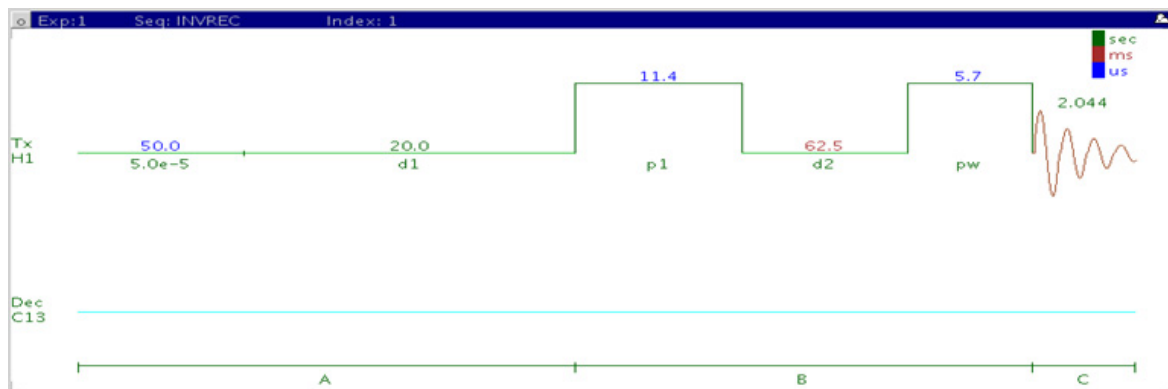

General description and usage

Description:

Uses an inversion-recovery pulse sequence (180° -d2- 90°) to measure spin-lattice (T_1 or longitudinal) relaxation rates.

Usage:

Knowledge of the T_1 relaxation rates for the sample is important for multiscan quantification experiments. Accurate quantification requires an interpulse delay of at least 5x the longest T_1 of interest in the molecule. All parameters are set from the "Acquire" tab/"Defaults" panel unless otherwise specified.

Key parameters



Parameter	Description
Solvent (solvent)	Set from "Start" tab/"Standard" panel
Spectral Width (sw)	Type in specific ppm values
Number of scans (nt)	Select typical choices from pull down menu*
Relaxation Delay (d1)	Select typical choices from pull down menu*- controls the delay between scans; set longer for accurate T ₁ measurements
Decoupling (dm)	Select choice from pull down menu- for X nuclei, choose coupled/uncoupled; +/- NOE
T1 Mode	Select choice from pull down menu- choose inversion recovery or progressive saturation
Min/Max T1; Total Exp Time	Use to set the array of values for the T ₁ d2 delay- choose a min/max value, select desired total exp time (controls # of steps) and click Array Relaxation Delay

NOTE

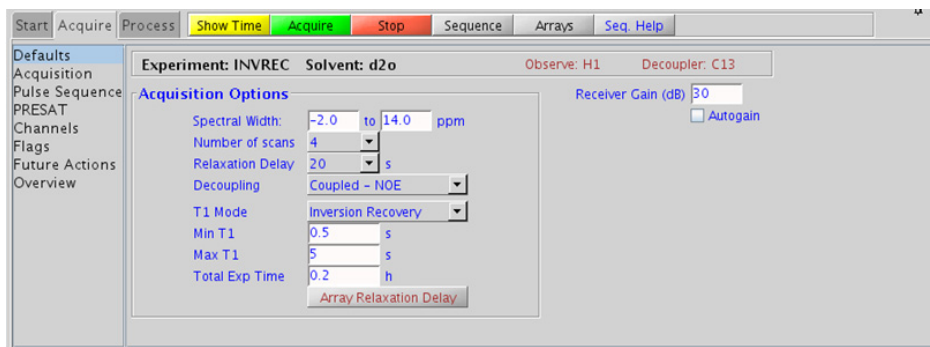
You can type specific values for these parameters manually in the appropriate boxes on the "Acquisition" panel.



Processing

The T1_MEASURE experiment, with the inversion recovery option selected, produces an array of 1D spectra, where the peaks heights slowly progress through zero and then become the opposite phase as the value of d2 increases. To process the entire array, use **Autoprocess**, or type “wft”. To display a single spectrum in the array, use the   buttons to choose a spectrum. Alternatively type ds(#), where # is the number of the spectrum in the array you wish to display. Clicking  on the vertical “ArrayedSpectra” panel displays all the spectra in a horizontal array. On the “Process” tab, there is a special panel labeled “T1 Analysis”. This panel contains tools to facilitate the T₁ analysis. Click **Display Last Spectrum**, expand the spectral region for the T₁ analysis and set the threshold just below the shortest analysis peak. Now click **Do T1 Analysis** to fit the data to T₁ curves for each peak. Use the display and print buttons to view the results.

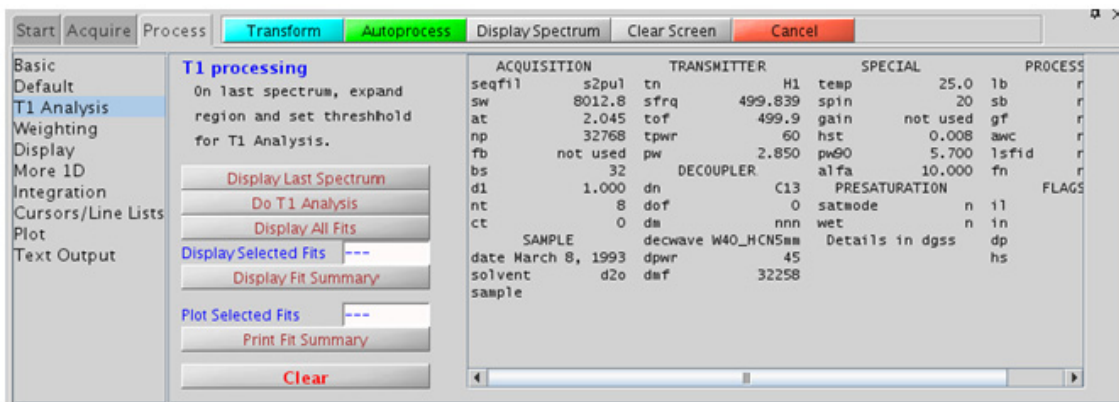

Tips, tricks, and next steps

- For the most accurate results, ensure that the relaxation delay is 5x the longest expected T₁- the default value is 20s, which assumes the longest T₁ is < 4s. If you find that your T₁ values of interest are longer, lengthen this delay appropriately and reacquire the data.

- The appropriate receiver gain (gain) is set from a PROTON spectrum with a 90° pulse angle. The “Autogain” option is not available for arrayed spectra.
- An accurate 90° pulse measurement is important for this experiment. For best results, measure the 90° pulse for your sample with a standard proton experiment before the T₁ analysis.
- To save time, you can perform the analysis initially with a small array containing a broad range of d2 values. Once you know the approximate value of d2 that produces the null, you can perform a second analysis with smaller array steps to target the exact value.
- To view the values in the d2 array, click  displayed underneath the spectrum when the “Acquire” tab is selected.
- If you are estimating the T₁ value visually from the null spectrum, remember that T₁ = d2*1.44, at the null point, as T₁ relaxation is a first-order rate process.

References:

A. Derome, Modern NMR Techniques for Chemistry Research, Pergamon Press, New York, 1987.

T2_MEASURE

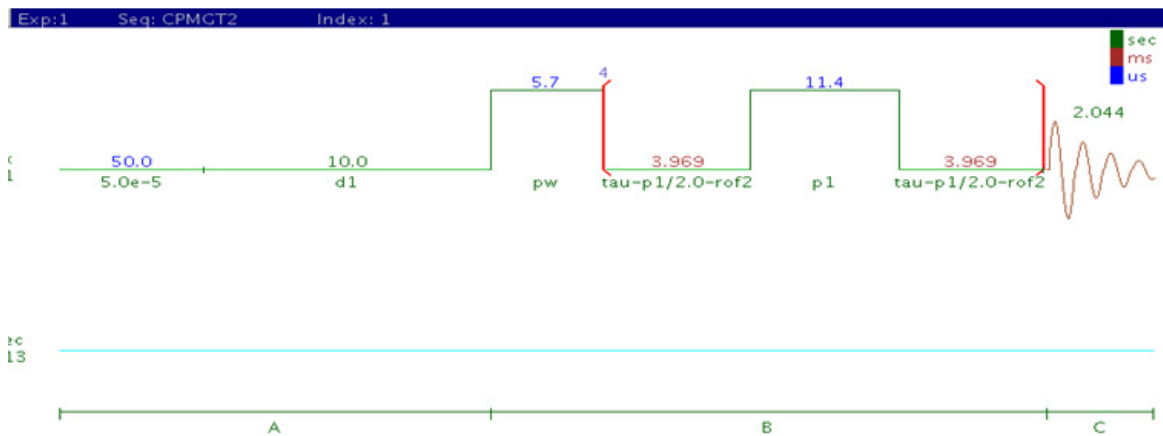

General description and usage

Description:

Uses a spin-echo pulse sequence to measure spin-spin (T_2 or transverse) relaxation rates.

Usage:

This experiment allows one to measure the transverse relaxation (T_2) in the absence of magnetic field inhomogeneity, rather than the rate constant for the decay of the FID (T_2^*), which is reflected in the 1D linewidths. T_2 relaxation rates are correlated with molecular size, so their measurement can provide insight for small molecules regarding aggregation, binding to large molecules (for example, proteins), or other noncovalent interactions. All parameters are set from the "Acquire" tab/"Defaults" panel unless otherwise specified.

Key parameters

Parameter	Description
Solvent (solvent)	Set from "Start" tab/"Standard" panel
Spectral Width (sw)	Type in specific ppm values
Number of scans (nt)	Select typical choices from pull down menu*
Relaxation Delay (d1)	Select typical choices from pull down menu*- controls the delay between scans; set longer for accurate T ₂ measurements
Decoupling (dm)	Select choice from pull down menu- for X nuclei, choose coupled/uncoupled; +/- NOE
Min/Max T ₂ ; Total Exp Time	Use to set the array of values for the T ₂ delay- choose a min/max value, select desired total exp time (controls # of steps) and click "Array Relaxation Delay" button



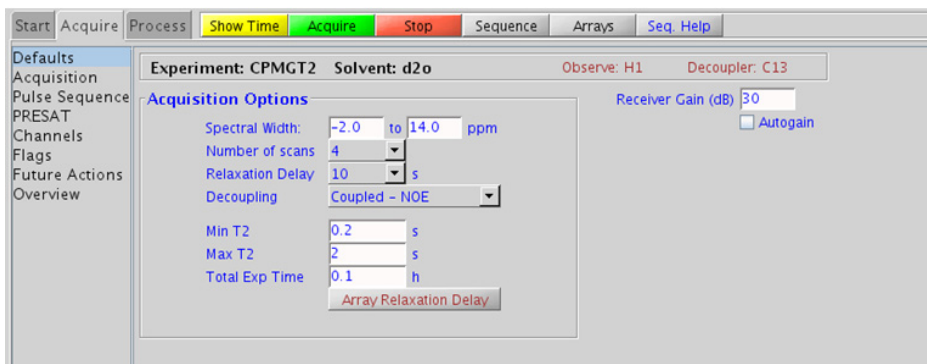

NOTE

You can type specific values for these parameters manually in the appropriate boxes on the "Acquisition" panel.



Processing

The T2_MEASURE experiment produces an array of 1D spectra, where the peaks heights slowly progress to zero as the value of the delay approaches the value for full T₂ relaxation. To process the entire array, use 

or type “wft”. To display a single spectrum in the array, use the   buttons to choose a spectrum. Alternatively type ds(#), where # is the number of the spectrum in the array you wish to display. Clicking  on the vertical “ArrayedSpectra” panel or typing “dssh” displays all the spectra in a horizontal array. On the “Process” tab, there is a special panel labeled “T₂ Analysis”. This panel contains tools to facilitate the T₂ analysis. Click , expand the spectral region for the T₂ analysis and set the threshold just below the shortest analysis peak. Now click  to fit the data to T₂ curves for each peak. Use the display and print buttons to view the results.

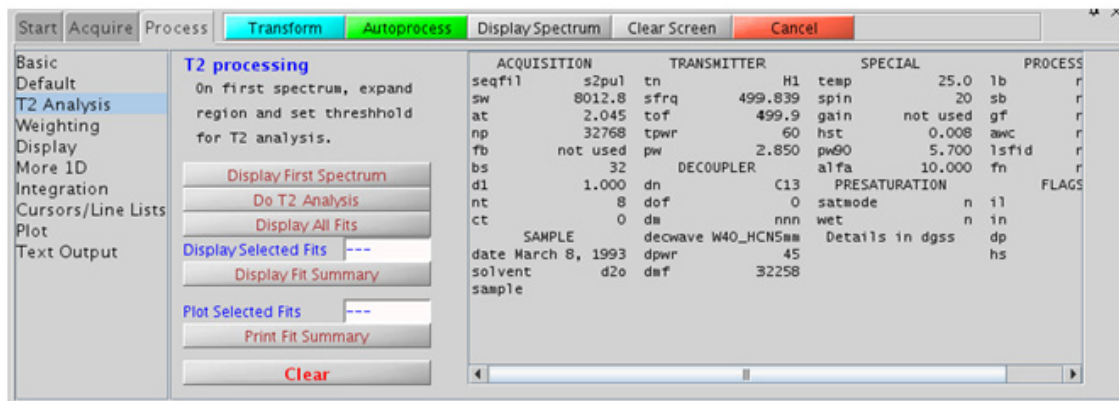

Tips, tricks, and next steps

- An accurate 90° pulse measurement is important for this experiment. For best results, measure the 90° pulse for your sample with a standard proton experiment before the T₂ analysis.

- The appropriate receiver gain (gain) is set from a PROTON spectrum with a 90° pulse angle. The “Autogain” option is not available for arrayed spectra.
- To save time, the analysis can be performed initially with a small array containing a broad range of T₂ values. Once the approximate value of T₂ that produces the null is determined, a second analysis can be performed with smaller array steps to target the exact value.
- To view the values in the d2 array, click  displayed underneath the spectrum when the “Acquire” tab is selected.
- Because broad peaks have short T₂ values, this sequence is sometimes used to remove large, broad, background peaks from spectra and flatten the baseline (“T2 filter”). Select a single, short value (0.1-0.2s) for the T₂ value (bigtau) and acquire the data.
- Strictly speaking, the T2_MEASURE experiment only works well on singlets. For example, it is good for ¹³C spectra. For coupled systems, multiplet distortion occurs during the echo, the degree of which depends on the value of T₂ delay.

References:

- H. Y. Carr, E. M. Purcell, Phys. Rev. 94 (1954) 630-638. (T2)
- S. Meiboom, D. Gill, Rev. Sci. Instrum. 29 (1958) 688-691. (T2)
- A. Derome, Modern NMR Techniques for Chemistry Research, Pergamon Press, New York, 1987.

2 Standard 1D - Std 1D (C)APT

(C)APT

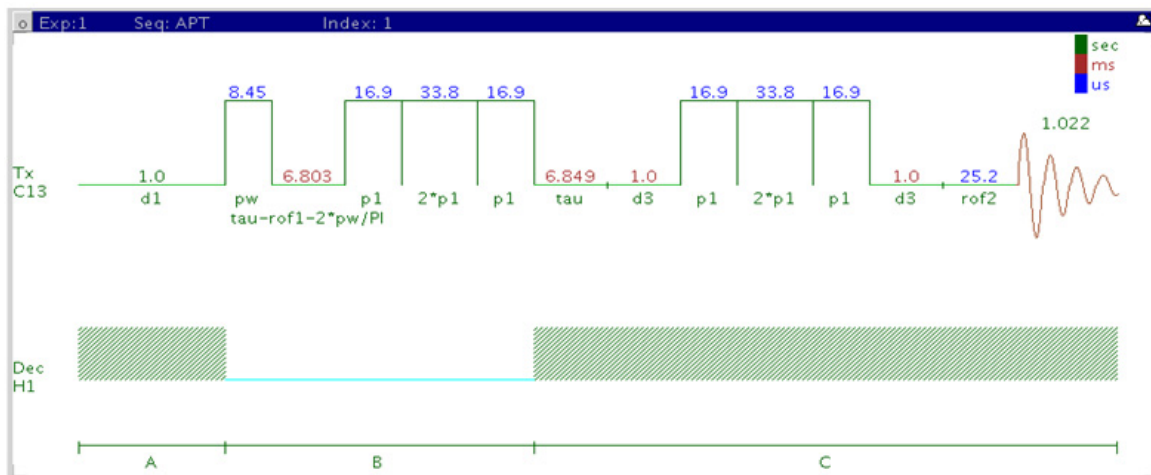

General description and usage

Description:

Attached proton test experiment to determine carbon multiplicity.

Usage:

The (C)APT experiment is used as an adjunct or a replacement for a 1D CARBON spectrum. The default parameters result in a spectrum with methyl and methine-type carbon signals having opposite phase with respect to that of methylenes and quaternary-type carbons. Quaternary carbon lines typically are smaller than methylene signals, and can often be distinguished in this manner. All parameters are set from the “Acquire” tab/”Defaults” panel unless otherwise specified.

Key parameters

Parameter	Description
Solvent (solvent)	Set from "Start" tab/"Standard" panel
Spectral Width (sw)	Select typical choices from the pull down menu or type in specific ppm values
Number of scans (nt)	Select typical choices from pull down menu*
Relaxation Delay (d1)	Select typical choices from pull down menu*- controls the delay between scans
Check S/N?	Select yes or no- acquires data until S/N value between ppm indicated is > specified value

NOTE

You can type specific values for these parameters manually in the appropriate boxes on the "Acquisition" panel.

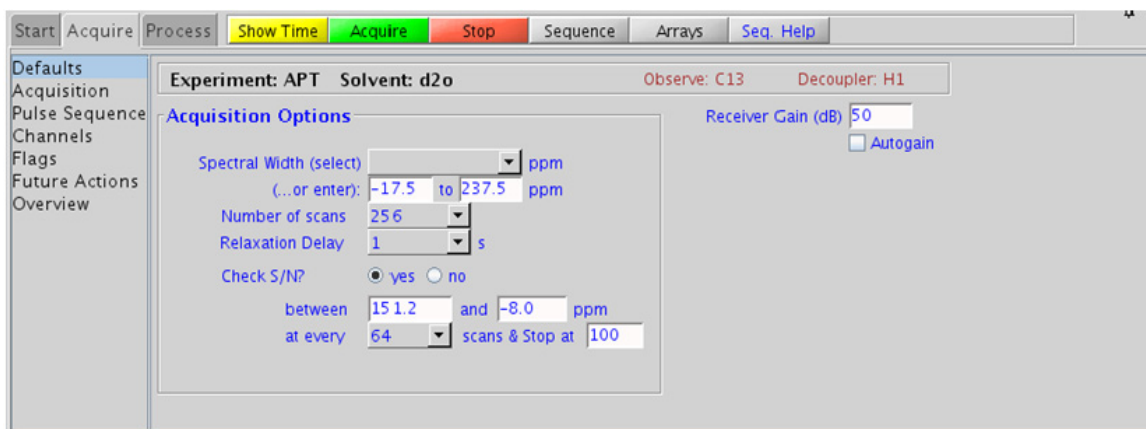

Processing

A typical processing weighting (apodization) choice that provides S/N enhancement (at the expense of resolution) for a 1D spectrum is line broadening, with an lb setting from $\sim 0.5 - 1$ Hz. Other types of weighting functions are available under the “Process” tab on the “Weighting” panel. Manual phasing may be necessary as the spectra often contain both positive and negative peaks. Proper phasing is typically with the solvent resonance “up” which results in quaternary and CH₂ carbons also pointing up and CH/CH₃ carbons pointing down.

Tips, tricks, and next steps

- Receiver gain (gain) is usually set to a high value (≥ 30), unless the sample is highly concentrated or ¹³C-labelled.
- The (C)DEPT experiment can produce edited carbon subspectra containing a single type of carbon multiplicity for easy interpretation. However the (C)APT is a single experiment, compared to multiple experiments for the full (C)DEPT series. Protonated carbons are also enhanced in DEPT by magnetization transfer from the protons as opposed to APT.
- If there is insufficient sample to obtain an (C)APT spectrum, consider acquiring proton-detected experiments such as gHSQC, which gives similar information and requires much less sample. The gHSQC experiment can also be acquired with multiplicity editing to give the same type of information as the (C)APT experiment.

References:

S. L. Patt, J.N. Shoolery, J. Magn. Reson. 46 (1982) 535-539. (APT)

(C)DEPT

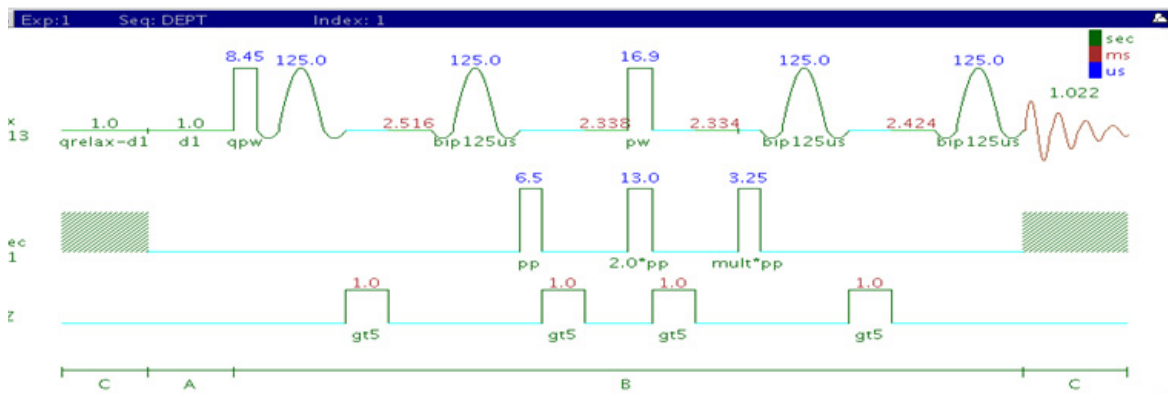

General description and usage

Description:

Experiment to determine carbon multiplicity.

Usage:

(C)DEPT experiments are used to produce edited subspectra of 1D carbon data that contain only carbons of a certain multiplicity type. Choices include (1) methines and methyls peaks positive, methylenes negative, (2) methines only, or (3) methyls, methylenes, and methines (no quaternary carbons). Mathematical combinations of the three choices can be used to produce spectra that contain only a specific type of carbon, for example, methylenes are only produced by the linear combination of choices 1 - 3. Additionally, quaternary carbons can be selected (DEPTQ) to be in-phase or anti-phase with respect to the methyls or not to be present at all (traditional DEPT). With full DEPTQ editing (eight spectra), quaternary carbons can also be separated out. Individual subspectra for each carbon are generated with the "Full Edit" choice of the "XH Multiplicity editing" pull down. All parameters are set from the "Acquire" tab/"Defaults" panel unless otherwise specified.

Key parameters

Parameter	Description
Solvent	Set from "Start" tab/"Standard" panel
Spectral Width (sw)	Select typical choices from the pull down menu or type in specific ppm values
Number of scans (nt)	Select typical choices from pull down menu*
Relaxation Delay (d1)	Select typical choices from pull down menu*
XH Multiplicity editing (mult)	Select choice of (C)DEPT experiment from pull down menu
Quaternary Carbons (qphase)	Select choice of DEPTQ- allows for the addition of antiphase or in-phase quat. carbons
Quat. 13C relax delay (qrelax)	Allows for an additional delay to be included for subspectra containing quat. carbons in the sequence

NOTE

You can type specific values for these parameters manually in the appropriate boxes on the "Acquisition" panel.

2 Standard 1D - Std 1D Processing

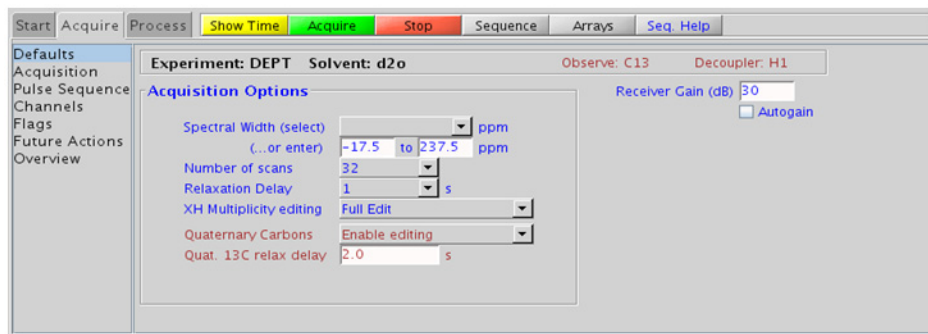

Processing

A typical processing weighting (apodization) choice that provides S/N enhancement (at the expense of resolution) for a 1D proton spectrum is line broadening, with an lb setting from $\sim 0.5 - 1$ Hz. Other types of weighting functions are available under the “Process” tab on the “Weighting” panel. Manual phasing may be necessary as the spectra can contain both positive and negative peaks.

Tips, tricks, and next steps

- Receiver gain (gain) is usually set to a high value (≥ 30), unless the sample is highly concentrated or ^{13}C -labelled.
- The (C)DEPT experiment can produce edited carbon subspectra containing a single type of carbon multiplicity for easy interpretation. Protonated carbons are also enhanced in DEPT by magnetization transfer from the protons as opposed to APT.
- A single DEPT experiment with the “XH/XH3 up & XH2 down” option along with the Quaternary carbon “Antiphase” option is a good alternative to APT, as it provides the same information, but with enhanced sensitivity for protonated carbons.

- If there is insufficient sample to obtain a (C)DEPT spectrum, consider acquiring proton-detected experiments such as gHSQC, which gives similar information and requires much less sample. The gHSQC experiment can also be acquired with multiplicity editing to give the same type of information as the (C)DEPT experiment.

References:

D. M. Doddrell D. T. Pegg M. R. Bendall, J. Magn. Reson. 48 (1982) 323-327. (DEPT)

M. A. Smith, H. Hu, A. J. Shaka, J. Magn. Reson. 151 (2001) 269-283. (BIP Pulses)

P. Bigler, R. Kummerle, W. Bermel, Magn. Reson. Chem. 45 (2007) 469-472. (DEPTq)

PureShift 1D

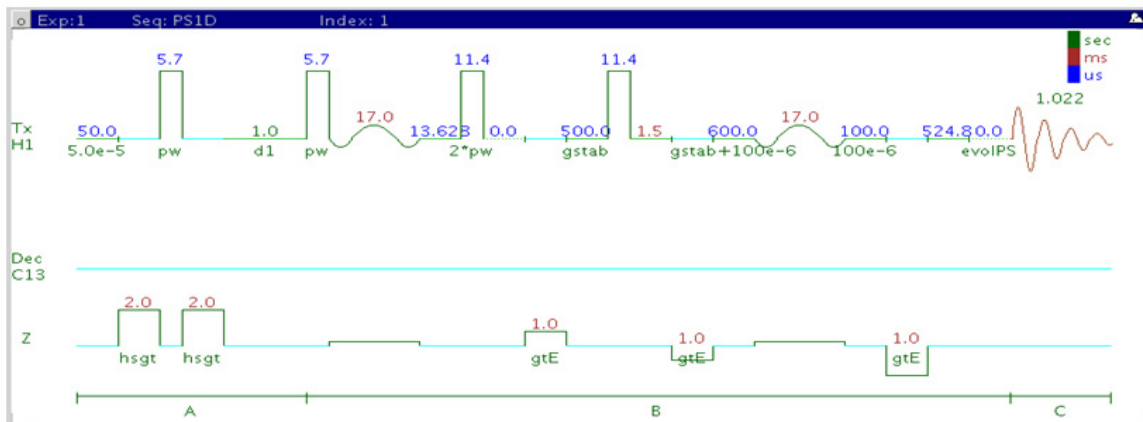

General description and usage

Description:

Uses a double spin-echo type experiment to acquire an effectively homonuclear-decoupled proton spectrum.

Usage:

The PureShift 1D experiment is useful to simplify complicated proton spectra dominated by overlapping multiplets. The result is a “proton-decoupled” spectrum of singlets at the true chemical shift of each proton multiplet. The sensitivity is much less than the standard proton experiment. All parameters are set from the “Acquire” tab/“Defaults” panel unless otherwise specified.

Key parameters

Parameter	Description
Solvent(solvent)	Set from "Start" tab/"Standard" panel
Spectral Width(sw)	Type in specific ppm values
Number of scans(nt)	Select typical choices from pull down menu*
Relaxation Delay(d1)	Select typical choices from pull down menu*- controls the delay between scans
Slice Selection Bandwidth	Bandwidth for selective pulse- 100-Hz standard
"PureShift tau delay"	Delay for effective homonuclear decoupling

NOTE

You can type specific values for these parameters manually in the appropriate boxes on the "Acquisition" panel.

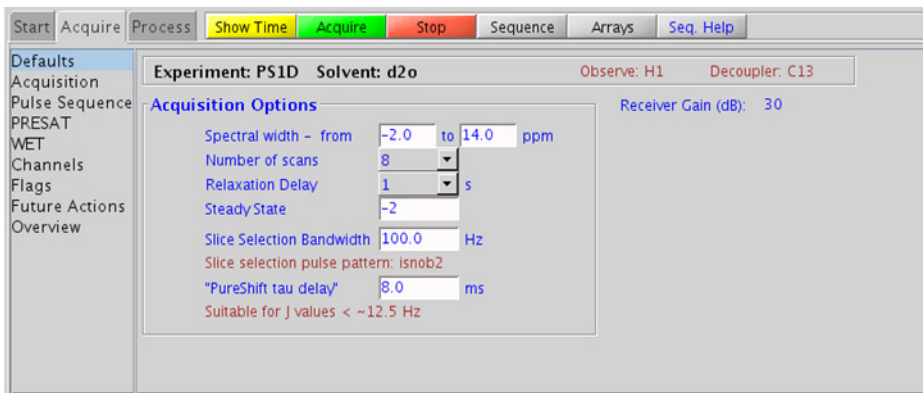

Processing

As the sensitivity of the PureShift 1D experiment is lacking compared to a standard PROTON, a good processing weighting choice is one which provides S/N enhancement, for example, line broadening (lb \sim 0.5 - 1 Hz).

Tips, tricks, and next steps

- Smaller bandwidths for the selective pulse result in greater selectivity (for example, decoupling of closely spaced coupling partners), but longer experiment times and lower sensitivity. 100 Hz is a good compromise starting point. Spectral width (sw) can also be decreased to include only the region of interest.
- The “PureShift tau delay” is inversely related to the maximum coupling constant that can be effectively decoupled. Decrease this delay for larger couplings- refer to the display in the panel for the effective maximum coupling constant.

References:

P. Xu, X. Wu, R. Freeman, J. Magn. Reson. 95 (1991) 132-148.
(Homonuclear Decoupling)

K. Zangger, H. Sterk, J. Magn. Reson. 124 (1997) 486-489. (Homonuclear Broadband Decoupling)

J. A. Aguilar, S. Faulkner, M. Nilsson, G. A. Morris, Angew. Chem. Int. Ed., 49 (2010) 3901-3903. (PureShift 1D)

(H)HomoDec

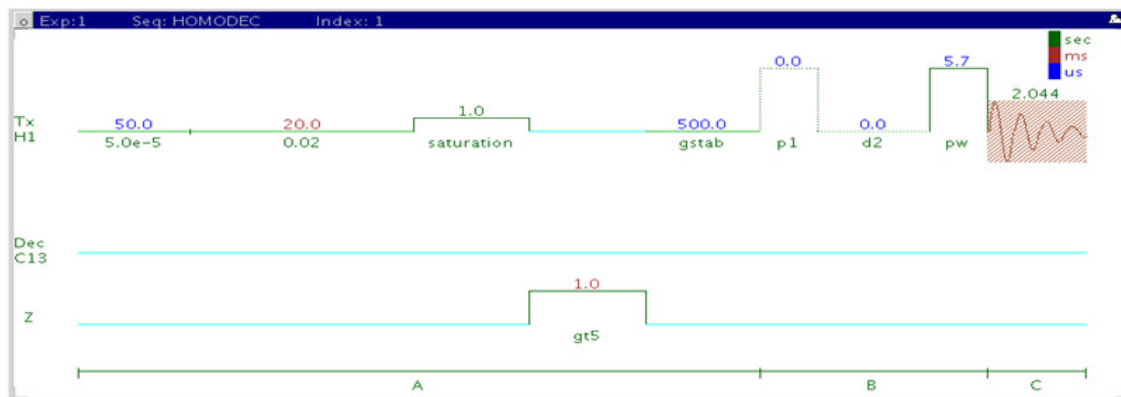

General description and usage

Description:

Uses basic irradiation to decouple a 1D-¹H dataset at a single frequency (hard pulse) or multiple frequencies (shaped pulse).

Usage:

Before widespread use of the 2D COSY and TOCSY experiments, this experiment was widely used to define homonuclear coupling partners. Irradiation at a given frequency for a multiplet results in a collapse of coupled multiplets. Where the TOCSY and/or COSY can be difficult to interpret due to overlap, this experiment may still be a good choice for simplifying highly coupled systems. In addition to the homonuclear decoupling (“homo”), which can be used in any pulse sequence, this sequence simultaneously saturates the signal which is decoupled to remove artifacts. This experiment is most easily set up from a previously acquired PROTON spectrum so the frequencies and widths for the decoupling are known, and can be chosen interactively with the cursor. All parameters are set from the “Acquire” tab/”Defaults” panel unless otherwise specified.

Key parameters

Parameter	Description
Solvent (solvent)	Set from "Start" tab/"Standard" panel
Spectral Width(sw)	Set from previously acquired PROTON*
Number of scans(nt)	Select typical choices from pull down menu*
Presaturate	Check box to presaturate the selected resonances to suppress decoupling artifacts – highly recommended
Decoupling Duty Cycle	Use to control % of time the decoupling is on- longer time improves decoupling at the expense of S/N (10% recommended)
Multifrequency Decoupling	Check box for multiple frequencies
No., ppm, width of selective frequencies	Use top box to set the number of selective frequencies. Boxes underneath are used to set the desired ppm and width in Hz of each frequency

NOTE

You can type specific values for these parameters manually in the appropriate boxes on the "Acquisition" panel.

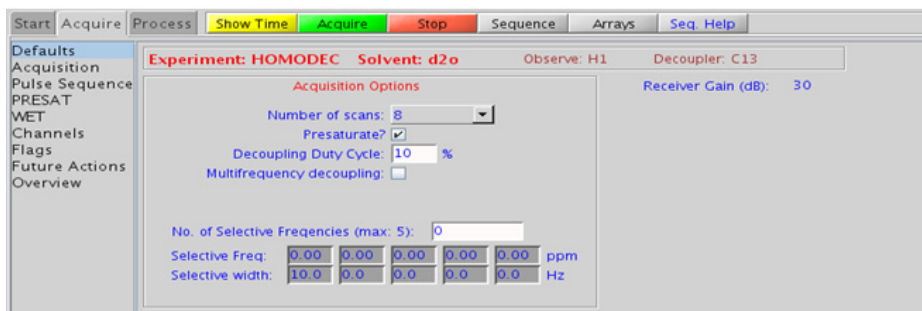

Processing

The processing is typically the same as the process used for standard PROTON spectrum, except manual phasing may be required due to antiphase/negative peaks at the decoupling frequency. A typical processing weighting (apodization) choice that provides S/N enhancement (at the expense of resolution) for a 1D proton spectrum is line broadening, with an lb setting from $\sim 0.5 - 1$ Hz. A suggested optimal value is line broadening equal to the unfiltered peak linewidth at half-height. Other types of weighting functions are available under the “Process” tab on the “Weighting” panel.

Tips, tricks, and next steps

- If the HOMODEC experiment is selected in an experiment already containing PROTON data, the decoupling band selection can be chosen interactively. Place the cursors around the multiplet to decouple and click “Select”. Repeat for multiple decoupling bands; click “CLEAR” to erase previous choices.

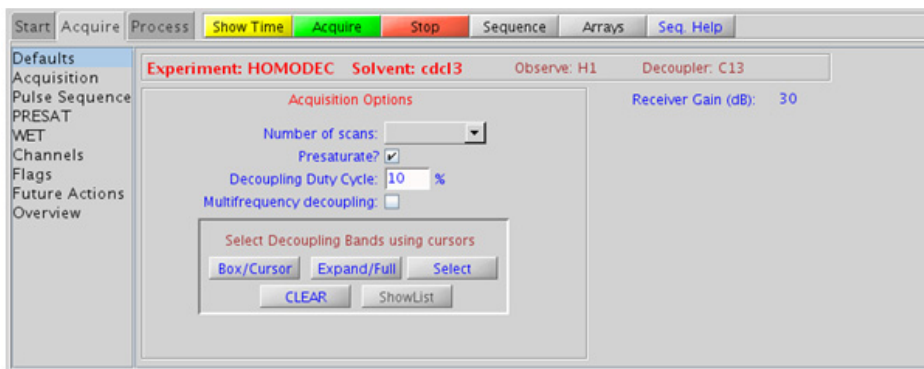

- Acquiring several spectra with single frequency decoupling usually give cleaner spectra and more easily interpretable results than one spectrum with multiple simultaneous decouplings.

- A 2D gCOSY/gDQCOSY spectrum may be a better choice for a standard structure elucidation/assignment problem as it can provide the same information for the entire molecule with a single experiment that can be obtained in <5 min. with a reasonable sample amount.

References:

J. K. M. Sanders, J. D. Mersh, Prog. NMR Spectsoc. 15 (1982) 353-400.
(Difference Spectroscopy)

CARBONecho

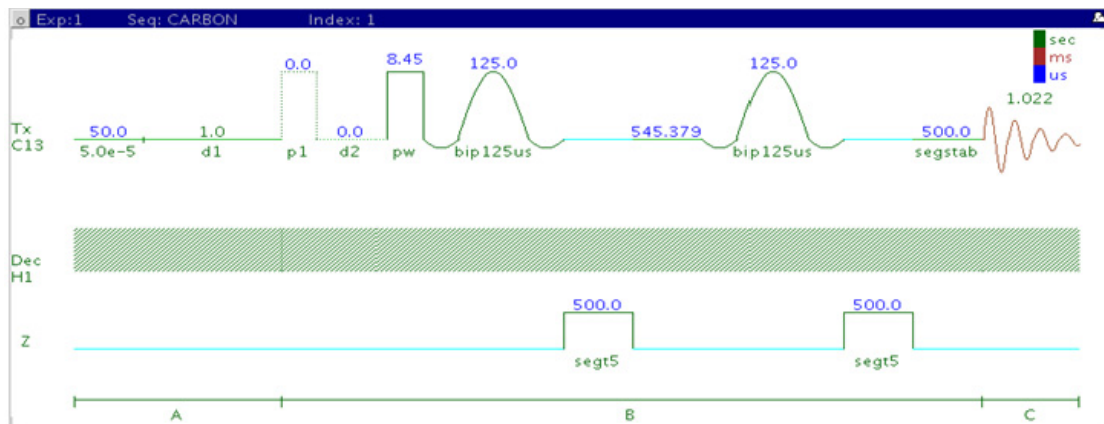

General description and usage

Description:

Acquires a 1D-¹³C dataset with a double echo from bip pulses to allow delayed data acquisition without the need for linear back prediction.

Usage:

This experiment is highly specialized to acquire 1D carbon data on a high Q probe, such as a ¹³C cold probe, which may have long pulse ringdown times. All parameters are set from the “Acquire” tab/”Default C13” panel unless otherwise specified.

Key parameters

Parameter	Description
Solvent (solvent)	Set from "Start" tab/"Standard" panel
Spectral Width (sw)	Select typical choices from pull down menu or type in specific ppm values
Number of scans (nt)	Select typical choices from pull down menu*
Relaxation Delay (d1)	Select typical choices from pull down menu*-controls the delay between scans
Pulse Angle	Select typical choices from pull down menu*-controls the tip angle for the pulse
H1 decoupling (dm)	Select typical choices from pull down menu- turns decoupling and/or NOE enhancement on/off
Check S/N?	Select yes or no- acquires data until S/N value between ppm indicated is > specified value
Acquisition time (at)	Set from "Pulse Sequence" panel, controls the digital resolution (Hz/point, 1/at)

NOTE

You can type specific values for these parameters manually in the appropriate boxes on the "Acquisition" panel.

2 Standard 1D - Std 1D Processing

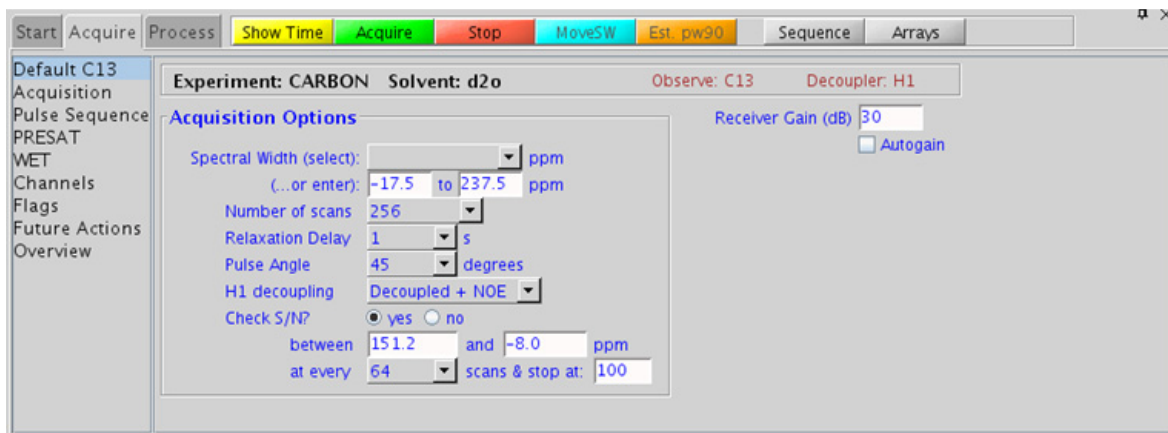

Processing

A typical processing weighting (apodization) choice that provides S/N enhancement (at the expense of resolution) for a 1D carbon spectrum is line broadening, with an lb setting from $\sim 0.5 - 1$ Hz.

Tips, tricks, and next steps

- The acquisition time, which controls the digital resolution (Hz/point, which is equal to $1/at$), is set on the “Acquisition” panel of the “Acquire” tab. Because carbon spectra are often acquired with large spectral widths, the default digital resolution (set from the chosen spectral width) may be insufficient to see small coupling; consider lengthening the acquisition time and/or narrowing the spectral width when acquiring coupled carbon spectra.
- Receiver gain (gain) is usually set to a high value (≥ 30), unless the sample is highly concentrated or ^{13}C -labelled.

- The standard proton-decoupled CARBONecho spectrum is produced by turning on the decoupling during the pulse and acquisition. It is also standard practice to leave the decoupler on during the preacquisition delay (d1), which provides an NOE enhancement to the carbon signals from attached protons. When more protons are attached to a carbon, the enhancement is larger. For example, methyl signals appear larger than quaternary carbon signals. Turn off the NOE enhancement if integration is desired.

References:

M. A. Smith, H. Hu, A. J. Shaka, J. Magn. Reson. 151 (2001) 269-283. (BIP Pulses)

BilevelDec

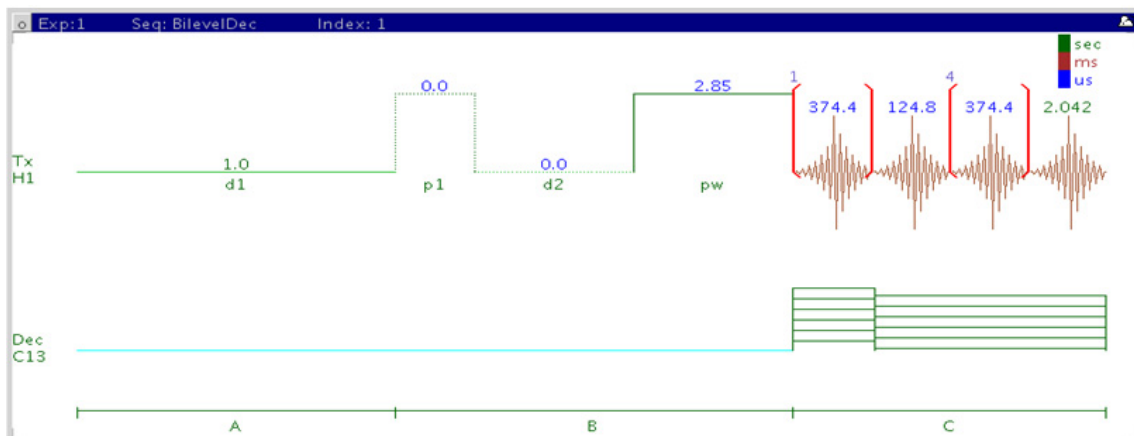

General description and usage

Description:

Used to acquire a carbon-decoupled 1D- ^1H dataset.

Usage:

This experiment is designed to acquire a 1D proton spectrum with heteronuclear decoupling. The bilevel style decoupling helps remove cyclic decoupling sidebands associated with large ^1H -X couplings by varying the length of the higher power decoupling at the beginning of the acquisition. These sidebands are often a problem when decoupling a nucleus of high abundance like ^{31}P . This experiment is also used for uniformly ^{13}C -labelled samples, which can have complex, difficult to interpret 1D PROTON spectra from ^{13}C - ^1H coupling.

Key parameters

Parameter	Description
Solvent (solvent)	Set from "Start" tab/"Standard" panel
Spectral Width(sw)	Type in specific ppm values
Number of scans(nt)	Select typical choices from pull down menu*
Relaxation Delay (d1)	Select typical choices from pull down menu*-controls the delay between scans
Pulse Angle	Select typical choices from pull down menu*-controls the tip angle for the pulse
Bilevel Decoupling ON/OFF	Check box to turn decoupling on/off
Decoupling bandwidth	Use to the desired bandwidth for decoupling- larger bandwidth means more power
Decoupler position	Use to set carbon decoupling frequency in ppm (50 ppm typically the center)

NOTE

You can type specific values for these parameters manually in the appropriate boxes on the "Acquisition" panel.

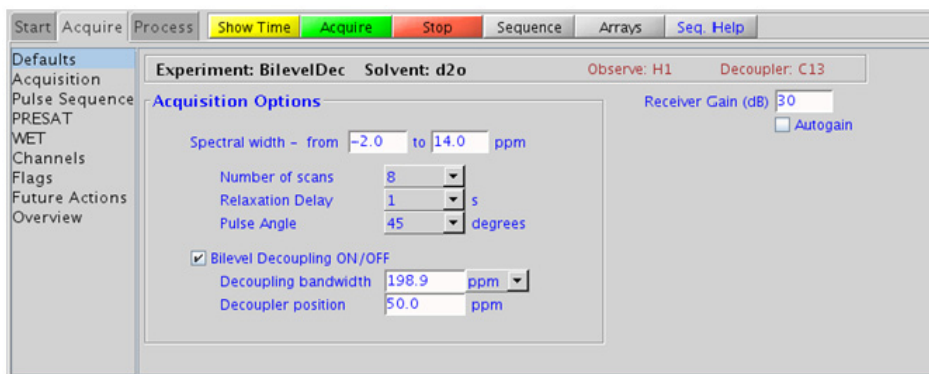

Processing

The processing is typically the same as the processing used for standard PROTON spectrum, except manual phasing may be required due to antiphase/negative peaks at the decoupling frequency. A typical processing weighting (apodization) choice that provides S/N enhancement (at the expense of resolution) for a 1D proton spectrum is line broadening, with an lb setting from $\sim 0.5 - 1$ Hz. A suggested optimal value is line broadening equal to the unfiltered peak linewidth at half-height. Other types of weighting functions are available under the “Process” tab on the “Weighting” panel.

Tips, tricks, and next steps

- The appropriate receiver gain (gain) is most easily set by making sure that the Autogain option is checked on the right side of the “Acquire” tab. The software optimizes the gain setting before data collection.
- If the ^{13}C -labelling is localized to a portion of the molecule, for example an aromatic ring, setting the decoupling position to the center of the labeled carbon region and narrowing the decoupling bandwidth can minimize the decoupling power.
- With probes of good ^{13}C efficiency (shorter 90° pulse lengths), BiLevelDEC can be used to acquire ^{13}C decoupled PROTON spectra with ^1H acquisition times of normal length and full band ^{13}C decoupling, provided a sufficiently long d1 relaxation delay is set, such at 10-20s. This experiment can be useful for quantitative NMR or trace analysis where it is desirable to move the ^{13}C satellites under the main ^1H peak resonance.

References:

E. Kupce, R. Freeman, G. Wider and K. Wütrich, J. Magn. Reson, Ser A. 122 (1996) 81-84. (Bilevel Decoupling)

2 Standard 1D - Std 1D

Tips, tricks, and next steps



3 Homonuclear 2D - (HH)Homo2D

(HH)Homo2D Tab 90

gCOSY 92

gDQCOSY 100

TOCSY 108

zTOCSY 112

ROESY 116

ROESYAD 120

NOESY 124

zCOSY 128



(HH)Homo2D Tab

This tab of the Experiment Selector includes the set of 2D experiments available for proton homonuclear correlations, including both J-coupling and through-space correlation experiments. The J-coupling experiments fall into two families, the COSY family that primarily displays connectivities from two- and three-bond couplings and the TOCSY family, which can show correlations among an entire spin system. The z-filtered versions of the experiments are also available as well as gradient enhanced coherence selection for the COSY experiments. The gradient enhanced version of the experiment experiences better artifact suppression at the expense of some loss of sensitivity (factor of ~ 1.4). In experiments involving z-magnetization (zTOCSY, zCOSY, NOESY) zero-quantum suppression is implemented and switched on by default. The through-space correlation experiments consist of both NOESY and ROESY with an additional option of an adiabatic spinlock for the ROESY. The adiabatic spinlock is preferable as the power is lower, permitting longer mixing times for the ROESYAD.

These experiments are considered essential data for small molecule structure elucidation following the 1D PROTON experiment. With reasonable amounts of material, the J-coupling experiments can often be acquired in 5 minutes or less. Because these experiments are proton-proton correlations, they are the most sensitive and have the best chance of providing additional structural data beyond the PROTON spectrum if the sample is limited.

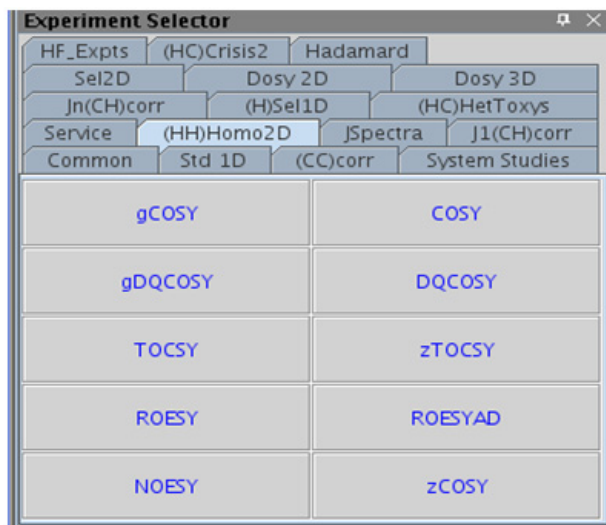

3 Homonuclear 2D - (HH)Homo2D gCOSY

gCOSY

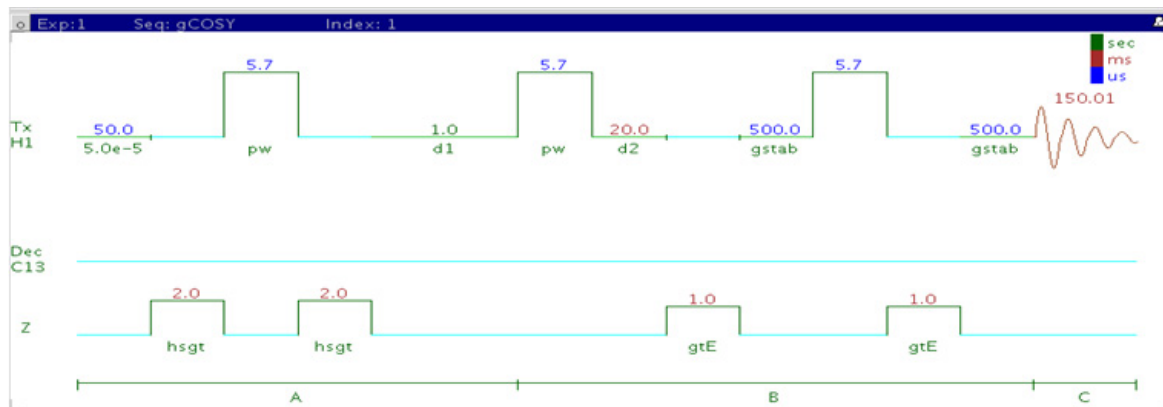

General description and usage

Description:

Two-Dimensional J-correlation spectroscopy with gradient coherence selection.

Usage:

This experiment produces a 2-dimensional, absolute-value, spectrum with peaks along the diagonal corresponding to the peaks in a 1D PROTON spectrum and crosspeaks between protons with nonzero couplings, typically 2 - 4 chemical bonds apart. This experiment is useful for assignment, particularly when some of the peak identities are known- the others can then be deduced from the crosspeaks observed. For structure elucidation, the protonated molecular fragments can be mapped out from the couplings. The gCOSY is a highly robust experiment and, along with TOCSY/zTOCSY, is among the most sensitive of the 2Ds, making it a popular choice for the organic chemistry NMR lab. All parameters are set from the "Acquire" tab/"Defaults" panel unless otherwise specified.

Key parameters

Parameter	Description
Spectral Width (sw)	Set from previously acquired PROTON*
Acquisition time (at)	Set from "Pulse Sequence" panel, controls the resolution in F2, default 0.15s
Scans per t1 increment (nt)	Select typical choices from pull down menu* no required minimum for the gCOSY
t1 Increments (ni)	Select typical choices from pull down menu*-controls the resolution in F1 (minimum ~64)
COSY-beta	Set from "Pulse Sequence" panel pull-down, choose COSY-45, 60, 90, or 135
Symmetrize	Check box for processing option to symmetrize along the diagonal
Steady State (ss)	Set from "Pulse Sequence" panel, turn on/off gradient cleanup between scans

NOTE

You can type specific values for these parameters manually in the appropriate boxes on the "Acquisition" panel.

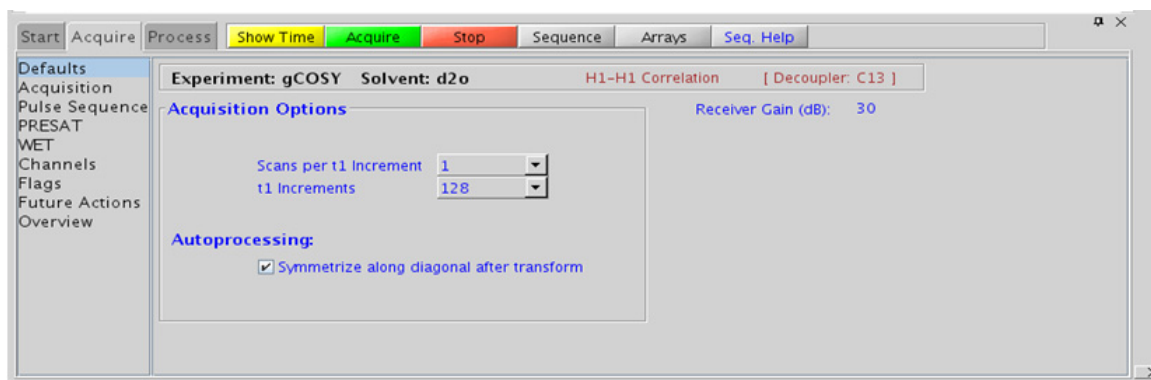

Processing

Automated processing is turned on by default, and the parameters are set to reasonable values, such that the resulting data after the acquisition usually requires no further adjustment. The “Process” tab/“Basic” panel contains many of the commonly modified processing parameters, such as a pull-down menu to change the FT data size (1k x 1k is the default), as well as a check box to turn on/off linear prediction and a pull-down menu to control the extent of linear prediction (default is 2*ni). Menus to change the weighting functions quickly in F2/F1 are also present (defaults are squared sinebells). More processing details are found under some of the other “Process” panels, such as the “Default”, “Weighting”, and “More 2D” panels.

Tips, tricks, and next steps

- Spectral width (sw) and receiver gain (gain) settings transfer from a PROTON if the gCOSY is set up from this experiment.
- The gCOSY is a high sensitivity experiment and data can often be collected using one scan per increment with reasonably concentrated samples. Consider increasing the number of increments (ni) and turning off linear prediction in f1 to increase the quality of the data for such samples.
- The COSY experiment has a sensitivity advantage (factor of ~1.4) over the gCOSY, but can produce potentially less clean spectra (due to t1 noise from strong signals such as t-butyl) than gCOSY. The COSY also requires a multiple of four scans per increment, as opposed to the gCOSY, which can be run with one scan per increment.
- The default number of steady state scans (ss) that are acquired before data acquisition to establish sample equilibrium is 32, which works for most samples. This value is changed on the “Acquisition” panel of the “Acquire” tab if necessary.

- The default value for the tip angle of the second pulse is set to 90°, producing a gCOSY-90. To acquire a gCOSY-45, go to the “Pulse Sequence” dialog box under the “Acquire” tab and select 45 degrees from the pull-down box for COSY-beta. The gCOSY-45 has less intense diagonal peaks than the gCOSY-90, making close chemical shift correlations easier to see at a loss of sensitivity. A 60° pulse can provide a compromise between the two.
- The d2 delay (default value 20msec) can be increased via the Pulse Sequence panel to emphasize crosspeaks originating from small couplings.
- The default parameters use a Grad-90-Grad steady state between scans, which helps cleanup unrelaxed magnetization. This can result in much cleaner spectra, especially when using shorter acquisition times (at) and relaxation delays (d1) (defaults are 0.15s and 1s, respectively).
- Spectral symmetrization can appear to provide an easy way of cleaning up artifacts such as t1 noise (noise along the F1 axis often observed at the chemical shift of sharp, intense peaks). However, it can produce spurious crosspeaks that appear real. When in doubt about the validity of a cross peak, examine the unsymmetrized spectrum as well.
- If the concentration is not very low, a gDQCOSY can be considered instead of the gCOSY. It typically leads to cleaner spectra (due to suppression of singlet diagonal peaks, such as t-butyl resonances) and yields higher resolution spectra.
- Complex molecules with many overlapping spin systems can be difficult to assign from a gCOSY. Consider using a zTOCSY in lieu of, or in conjunction with the gCOSY data as the zTOCSY experiment is better at identifying the entire spin system of protons.

References:

W. P. Aue, J. Karhan, R. R. Ernst, J. Chem. Phys. 64 (1976) 4226-4227. (COSY)

R. E. Hurd, J. Magn. Reson. 87 (1990) 422-428. (Gradient based Coherence Selection)

COSY

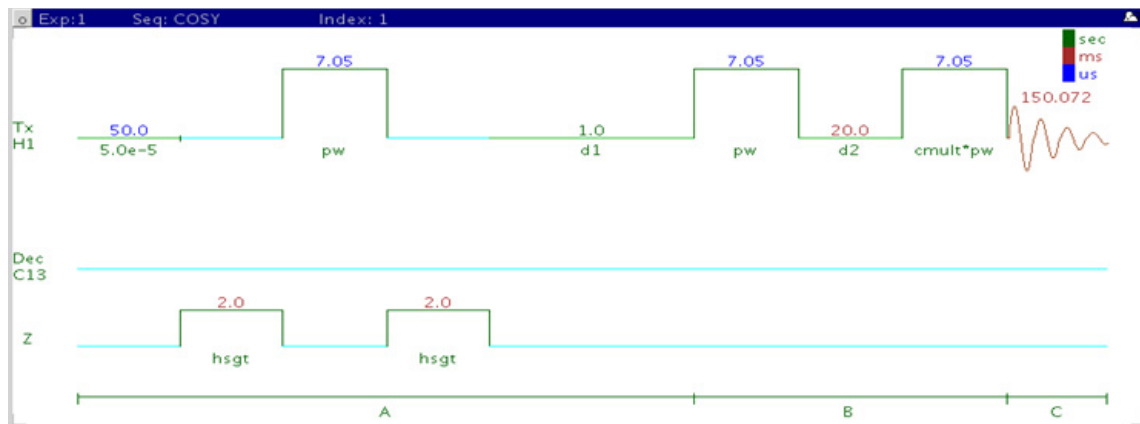

General description and usage

Description:

Two-Dimensional J-correlation spectroscopy.

Usage:

This experiment produces a 2-dimensional, absolute-value, spectrum with peaks along the diagonal corresponding to the peaks in a 1D PROTON and crosspeaks between protons with nonzero couplings, typically 2 - 4 chemical bonds apart. This experiment is useful for assignment, particularly when some of the peak identities are known- the others can then be deduced from the crosspeaks observed. For structure elucidation, the protonated molecular fragments can be mapped out from the couplings. The COSY is a highly robust experiment and, along with TOCSY, is among the most sensitive of the 2Ds, making it a popular choice for the organic chemistry NMR lab. All parameters are set from the "Acquire" tab/"Defaults" panel unless otherwise specified.

Key parameters

Parameters	Description
Spectral Width (sw)	Set from previously acquired PROTON*
Acquisition time (at)	Set from "Pulse Sequence" panel, controls the resolution in F2, default 0.15s
Scans per t1 increment (nt)	Select typical choices from pull down menu*
t1 Increments (ni)	Select typical choices from pull down menu*- controls the resolution in F1 (minimum ~64)
COSY-beta	Set from "Pulse Sequence" panel pull-down, choose COSY-45, 60, 90, or 135
Symmetrize	Processing option to symmetrize along the diagonal
Steady State (ss)	Set from "Pulse Sequence" panel, turn on/off gradient cleanup between scans

NOTE

You can type specific values for these parameters manually in the appropriate boxes on the "Acquisition" panel.

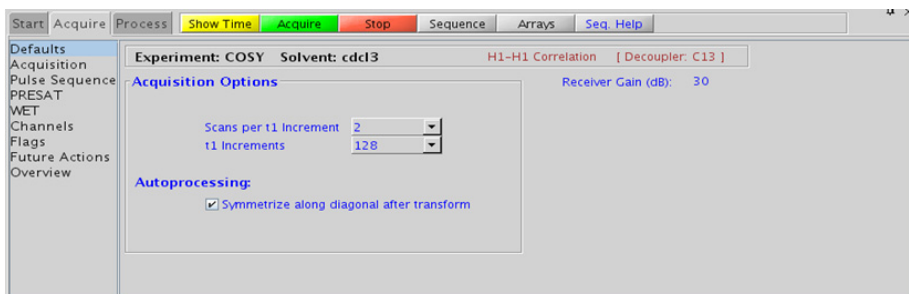

Processing

Automated processing is turned on by default, and the parameters are set to reasonable values, such that the resulting data after the acquisition usually requires no further adjustment. The “Process” tab/“Basic” panel contains many of the commonly modified processing parameters, such as a pull-down menu to change the FT data size (1k x 1k is the default), as well as a check box to turn on/off linear prediction and a pull-down to control the extent of linear prediction (default is 2*ni). Menus to quickly change the weighting functions in F2/F1 are also present (defaults are squared sinebells). More processing details are found under some of the other “Process” panels, such as the “Default”, “Weighting”, and “More 2D” panels.

Tips, tricks, and next steps

- Spectral width (sw) and receiver gain (gain) settings transfer from a PROTON if the COSY is set up from this experiment.
- The COSY experiment has a sensitivity advantage (factor of ~1.4) over the gCOSY but can produce potentially less clean spectra (due to t1 noise from strong signals such as t-butyl) than gCOSY. The COSY also requires a multiple of four scans per increment, as opposed to the gCOSY, which can be run with one scan per increment.
- The default number of “steady state” or “dummy scans” that are acquired before data acquisition to establish sample equilibrium is 32, which works for most samples. This value is changed on the “Acquisition” panel of the “Acquire” tab if necessary.
- The default value for the tip angle of the second pulse is set to 90°, producing a COSY-90. To acquire a COSY-45, go to the “Pulse Sequence” dialog box under the “Acquire” tab and select 45 degrees from the pull-down box for COSY-beta. The COSY-45 has less intense diagonal peaks than the COSY-90, making close chemical shift correlations easier to see at a loss of sensitivity. A 60° pulse can provide a compromise between the two.
- The d2 delay (default value 20msec) can be increased via the Pulse Sequence panel to emphasize crosspeaks originating from small couplings.

- The default parameters use a Grad-90-Grad steady state between scans, which helps cleanup unrelaxed magnetization. This can result in much cleaner spectra, especially when using shorter acquisition times, and d1 relaxation delays (defaults are 0.15s and 1s, respectively).
- Spectral symmetrization can appear to provide an easy way of cleaning up artifacts such as t1 noise (noise along the F1 axis often observed at the chemical shift of sharp, intense peaks). However it can produce spurious crosspeaks that appear real. When in doubt about the validity of a cross peak, examine the unsymmetrized spectrum as well.
- Complex molecules with many overlapping spin systems can be difficult to assign from a COSY- consider using a zTOCSY instead of, or in conjunction with the COSY data as the zTOCSY experiment is better at identifying the entire spin system of protons together.

References:

J. Jeener, Ampere International Summer School, Basko Polje, Yugoslavia 1971. (Introduction to 2D)

W. P. Aue, J. Karhan, R. R. Ernst, J. Chem. Phys. 64 (1976) 4226-4227. (COSY)

D. L. Turner, Prog. NMR. Spectrosc. 17 (1985) 281-358. (2D NMR)

3 Homonuclear 2D - (HH)Homo2D gDQCOSY

gDQCOSY

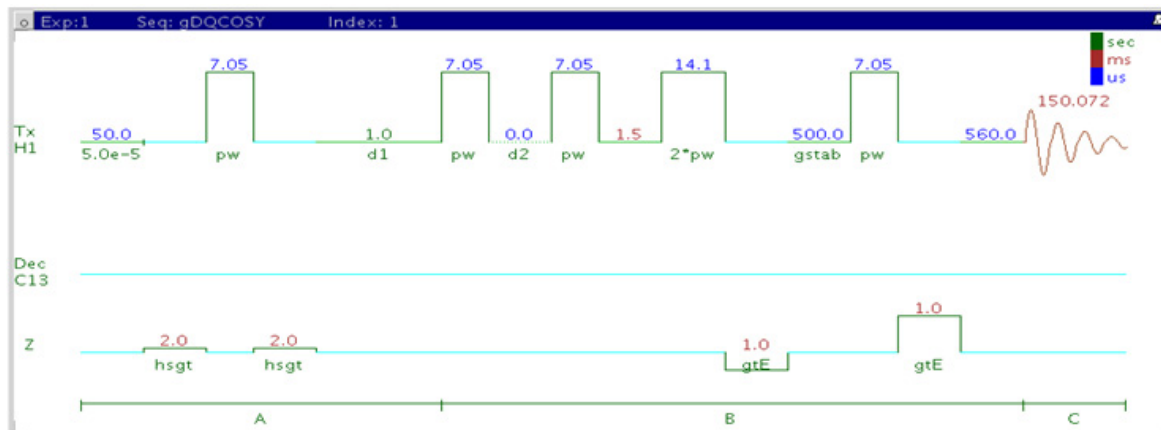

General description and usage

Description:

Two-Dimensional double-quantum filtered J-correlation spectroscopy with gradient coherence selection.

Usage:

This experiment produces a 2-dimensional spectrum with peaks along the diagonal corresponding to the peaks in a 1D PROTON and crosspeaks between protons with nonzero couplings, typically 2 - 4 chemical bonds apart. This experiment is useful for assignment, particularly when some of the peak identities are known- the others can then be deduced from the crosspeaks observed. For structure elucidation, the protonated molecular fragments can be mapped out from the couplings. The advantage of the gDQCOSY over the gCOSY is that peaks with no double-quantum transitions (for example, singlets) are suppressed, producing cleaner spectra. The experiment is also phase sensitive, resulting in better peak

shapes. Calibrate the 90° pulse width accurately for this experiment. All parameters are set from the “Acquire” tab/”Defaults” panel unless otherwise specified.

Key parameters

Parameter	Description
Spectral Width (sw)	Set from previously acquired PROTON*
Acquisition time (at)	Set from “Pulse Sequence” panel, controls the resolution in F2, default 0.15s
Scans per t1 increment (nt)	Select typical choices from pull down menu*- no required minimum for the gDQCOSY
t1 Increments (ni)	Select typical choices from pull down menu*- controls the resolution in F1 (minimum ~64)
Steady State (ss)	Set from “Pulse Sequence” panel, turn on/off gradient cleanup between scans

NOTE

You can type specific values for these parameters manually in the appropriate boxes on the “Acquisition” panel.

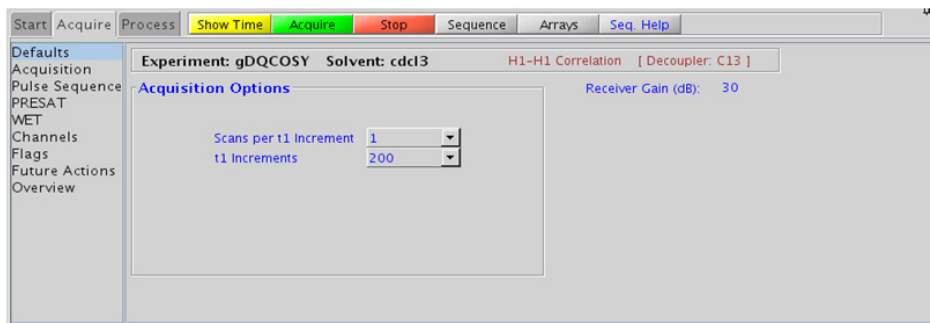

Processing

Automated processing is turned on by default, and the parameters are set to reasonable values, such that the resulting data after the acquisition usually require no further adjustment. The “Process” tab/“Basic” panel contains many of the commonly modified processing parameters, such as a pull-down menu to change the FT data size (1k x 1k is the default), as well as a check box to turn on/off linear prediction and a pull-down to control the extent of linear prediction (default is 2*ni). Menus to quickly change the weighting functions in F2/F1 are also present (defaults are shifted sinebells). More processing details are found under some of the other “Process” panels, such as the “Default”, “Weighting”, and “More 2D” panels.

Tips, tricks, and next steps

- Spectral width (sw) and receiver gain (gain) settings transfer from a PROTON if the gDQCOSY is set up from this experiment.
- The main advantage of the gDQCOSY versus the gCOSY is better resolution (phase sensitive versus absolute value experiment) and the absence of singlets that display no couplings. For instance, t-butyl signals, which can be a large source of t1 noise because of their intensity, are suppressed in a gDQCOSY.
- The DQCOSY experiment has a sensitivity advantage (factor of ~1.4) over the gDQCOSY but can produce potentially less clean spectra (due to t1 noise from strong signals) than gDQCOSY. The DQCOSY also requires a multiple of four scans per increment, as opposed to the gDQCOSY, which can be run with one scan per increment.
- The default number of “steady state” or “dummy scans” that are acquired before data acquisition to establish sample equilibrium is 32, which works for most samples. This value is changed on the “Acquisition” panel of the “Acquire” tab if necessary.
- The 90° pulse width is typically calibrated reasonably well for best results from the gDQCOSY experiment. See the PROTON experiment in Chapter 2 to calibrate the pulse.

- Because the J-couplings evolve as an echo in gDQCOSY, the crosspeaks arising from small couplings may not appear until the number of completed increments is sufficient. In general, it is useful to set n_i to a larger value than is the case in an experiment such as gCOSY.
- The default parameters use a Grad-90-Grad steady state between scans, which helps cleanup unrelaxed magnetization. This can result in much cleaner spectra, especially when using shorter acquisition times, and d_1 relaxation delays (defaults are 0.15s and 1s, respectively).
- The gDQCOSY experiment can be used to measure coupling constants of overlapped multiplets as the crosspeaks contain the full multiplet structure. If used for coupling constant measurement, run this experiment with many increments (n_i typically to 400 or higher). The zCOSY is a better alternative for coupling constant measurements than the gDQCOSY.
- Complex molecules with many overlapping spin systems can be difficult to assign from a gDQCOSY- consider using a zTOCSY instead of, or in conjunction with the gDQCOSY data as the zTOCSY experiment is better at identifying the entire spin system of protons.

References:

W. P. Aue, J. Karhan, R. R. Ernst, J. Chem. Phys. 64 (1976) 4226-4227. (COSY)

U. Piantini, O. W. Sorensen, R. R. Ernst, J. Am. Chem. Soc. 104 (1982) 6800-6801. (Double Quantum Filter)

R. E. Hurd, J. Magn. Reson. 87 (1990) 422-428. (Gradient based Coherence Selection)

3 Homonuclear 2D - (HH)Homo2D DQCOSY

DQCOSY

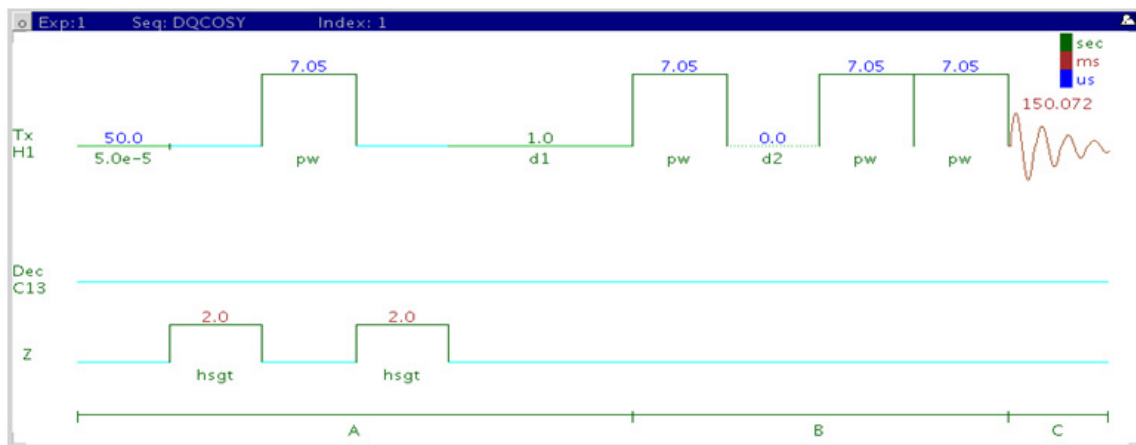

General description and usage

Description:

Two-Dimensional double-quantum filtered J-correlation spectroscopy.

Usage:

This experiment produces a 2-dimensional spectrum with peaks along the diagonal corresponding to the peaks in a 1D PROTON and crosspeaks between protons with 2- (geminal) or 3- (vicinal)-bond couplings. This experiment is useful for assignment, particularly when some of the peak identities are known- the others can then be deduced from the crosspeaks observed. For structure elucidation, the protonated molecular fragments can be mapped out from the couplings. The advantage of the DQCOSY over the COSY is that peaks with no double-quantum transitions (for example, singlets) are suppressed, producing cleaner spectra. The experiment is also phase sensitive, resulting in better peak shapes. The

90° pulse width is typically calibrated accurately for this experiment. All parameters are set from the “Acquire” tab/”Defaults” panel unless otherwise specified.

Key parameters

Parameter	Description
Spectral Width (sw)	Set from previously acquired PROTON*
Acquisition time (at)	Set from “Pulse Sequence” panel, controls the resolution in F2, default 0.15s
Scans per t1 increment (nt)	Select typical choices from pull down menu*
t1 Increments (ni)	Select typical choices from pull down menu*- controls the resolution in F1 (minimum ~64)
Steady State (ss)	Set from “Pulse Sequence” panel, turn on/off gradient cleanup between scans

NOTE

You can type specific values for these parameters manually in the appropriate boxes on the “Acquisition” panel.

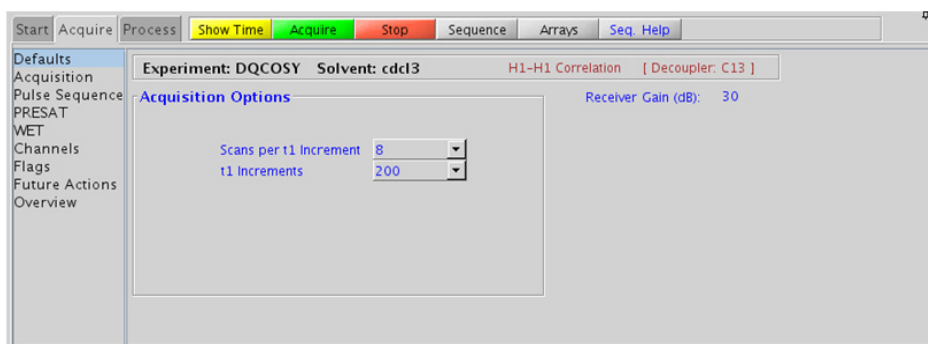

Processing

Automated processing is turned on by default, and the parameters are set to reasonable values, such that the resulting data after the acquisition usually require no further adjustment. The “Process” tab/“Basic” panel contains many of the commonly modified processing parameters, such as a pull-down menu to change the FT data size (1k x 1k is the default), as well as a check box to turn on/off linear prediction and a pull-down to control the extent of linear prediction (default is 2*ni). Menus to quickly change the weighting functions in F2/F1 are also present (defaults are shifted sinebells). More processing details are found under some of the other “Process” panels, such as the “Default”, “Weighting”, and “More 2D” panels.

Tips, tricks, and next steps

- Spectral width (sw) and receiver gain (gain)-settings transfer from a PROTON if the DQCOSY is set up from this experiment.
- The main advantage of the DQCOSY versus the COSY is better resolution (phase sensitive versus absolute value experiment) and the absence of singlets that display no couplings. For instance, t-butyl signals, which can be a large source of t1 noise because of their intensity, are suppressed in a DQCOSY.
- The DQCOSY experiment has a sensitivity advantage (factor of ~1.4) over the gDQCOSY but can produce potentially less clean spectra (due to t1 noise from strong signals) than gDQCOSY. The DQCOSY also requires a multiple of four scans per increment, as opposed to the gDQCOSY, which can be run with one scan per increment.
- The default number of “steady state” or “dummy scans” that are acquired before data acquisition to establish sample equilibrium is 32, which works for most samples. This value is changed on the “Acquisition” panel of the “Acquire” tab if necessary.
- Calibrate the 90° pulse width accurately for best results from the DQCOSY experiment. See the PROTON experiment in Chapter 2 to calibrate the pulse.

- Because the J-couplings evolve as an echo in DQCOSY, the crosspeaks arising from small couplings may not appear until the number of completed increments is sufficient. In general, it is useful to set n_i to a larger value than is the case in an experiment such as gCOSY.
- The default parameters use a Grad-90-Grad steady state between scans, which helps cleanup unrelaxed magnetization. This can result in much cleaner spectra, especially when using shorter acquisition times, and d_1 relaxation delays (defaults are 0.15s and 1s, respectively).
- The DQCOSY experiment can be used to measure coupling constants of overlapped multiplets as the crosspeaks contain the full multiplet structure. If used for coupling constant measurement, run this experiment with many increments (n_i typically to 400 or higher).
- Complex molecules with many overlapping spin systems can be difficult to assign from a DQCOSY- consider using a zTOCSY instead of, or in conjunction with the DQCOSY data as the zTOCSY experiment is better at identifying the entire spin system of protons.

References:

- W. P. Aue, J. Karhan, R. R. Ernst, J. Chem. Phys. 64 (1976) 4226-4227. (COSY)
- U. Piantini, O. W. Sorensen, R. R. Ernst, J. Am. Chem. Soc. 104 (1982) 6800-6801. (Double Quantum Filter)

TOCSY

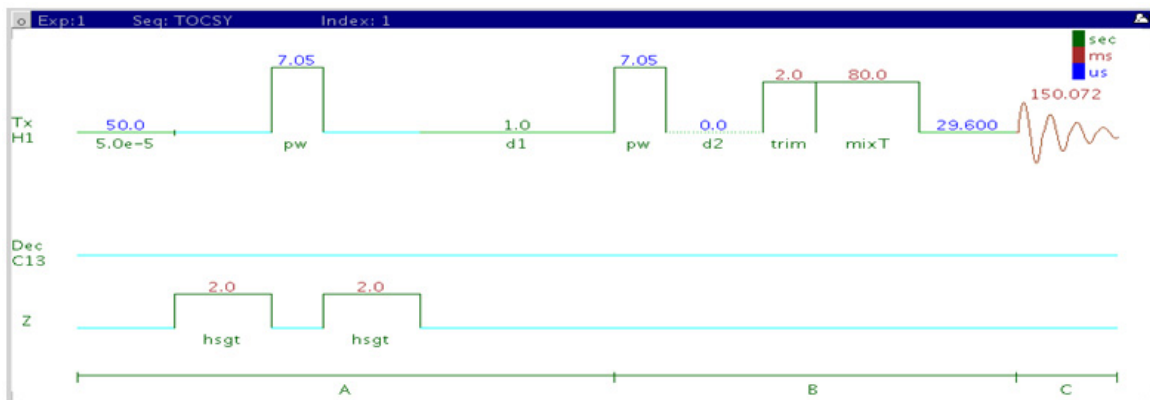

General description and usage

Description:

Two dimensional total J-correlation spectroscopy for scalar coupled spin systems.

Usage:

This experiment produces a 2-dimensional spectrum with peaks along the diagonal corresponding to the peaks in a 1D PROTON and crosspeaks potentially between all protons in a scalar coupled spin system. This experiment is useful for assignment, particularly for complex molecules with multiple overlapping spin systems, for example, peptides. For structure elucidation, the molecular fragments containing individual spin systems can be mapped out from the correlations. The TOCSY is a highly robust experiment and, along with gCOSY, is among the most sensitive of the 2Ds, making it a popular choice for the organic chemistry NMR lab. All parameters are set from the "Acquire" tab/"Defaults" panel unless otherwise specified.

Key parameters

Parameter	Description
Spectral Width (sw)	Set from previously acquired PROTON*
Acquisition time (at)	Set from "Pulse Sequence" panel, controls the resolution in F2, default 0.15s
Scans per t1 increment (nt)	Select typical choices from pull down menu*
t1 Increments (ni)	Select typical choices from pull down menu*- controls the resolution in F1 (minimum ~64)
Spinlock Pattern	Pull-down menu on the "Pulse Sequence" panel- MLEV17 or DIPSI2 work well for small molecules; clean MLEV17 or DIPSI2 are good choices for large molecules
Spinlock Duration (mixT)	Select from pull down menu- 80ms work best for large spin systems*
Steady State (ss)	Set from "Pulse Sequence" panel, turn on/off gradient cleanup between scans

NOTE

You can type specific values for these parameters manually in the appropriate boxes on the "Acquisition" or "Pulse Sequence" panels.

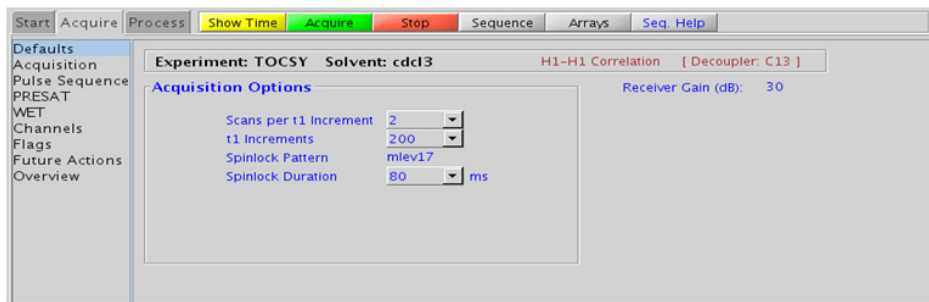

Processing

Automated processing is turned on by default, and the parameters are set to reasonable values, such that the resulting data after the acquisition usually require no further adjustment. The “Process” tab/“Basic” panel contains many of the commonly modified processing parameters, such as a pull-down menu to change the FT data size (1k x 1k is the default), as well as a check box to turn on/off linear prediction and a pull-down to control the extent of linear prediction (default is $2 \times ni$). Menus to quickly change the weighting functions in F2/F1 are also present (defaults are Gaussians). More processing details are found under some of the other “Process” panels, such as the “Default”, “Weighting”, and “More 2D” panels.

Tips, tricks, and next steps

- Spectral width (sw) and receiver gain (gain) settings transfer from a PROTON if the TOCSY is set up from this experiment.
- The TOCSY is a high sensitivity experiment and data can often be collected using one scan per increment with reasonably concentrated samples. Consider increasing the number of increments (ni) to increase the quality of the data for such samples.
- The default number of “steady state” or “dummy scans” that are acquired before data acquisition to establish sample equilibrium is 32, which works for most samples. This value is changed on the “Acquisition” panel of the “Acquire” tab if necessary.
- The spinlock time (in addition to the magnitude of the coupling constants) ultimately controls how far along the spin system the correlations extend. Use spinlock durations exceeding 150ms with caution, as this can result in sample heating. The efficiency of the TOCSY transfer is directly proportional to the size of the coupling constants between the pairs of protons. To show primarily vicinal and geminal couplings (such as for a COSY), select a shorter spinlock time, for example, 30ms or less. Such short spinlock TOCSY is a good alternative to gCOSY as TOCSY gives pure absorptive lineshape and potentially improved resolution.

- The MLEV17 and DIPSI2 spinlock patterns are good choices for small molecules, and the DIPSI3 and clean MLEV are typically used for larger molecules.
- The default parameters use a Grad-90-Grad steady state between scans, which helps cleanup unrelaxed magnetization. This can result in much cleaner spectra, especially when using shorter acquisition times, and d1 relaxation delays (defaults are 0.15s and 1s, respectively).
- The zTOCSY experiment contains a zero-quantum filter and usually results in cleaner spectra than the TOCSY experiment. Only zTOCSY experiment can be combined with zero-quantum filters.

References:

A. Bax, D. G. Davis, J. Magn. Reson. 63 (1985) 355-360. (TOCSY with MLEV17)

C. Griesinger, G. Otting, K. Wuethrich, R. R. Ernst, J. Am. Chem. Soc. 110 (1988) 7870-7872. (TOCSY with clean MLEV17)

J. Cavanaugh, M. Rance, J. Magn. Reson. 96 (1992) 670-678. (TOCSY with DIPSI2)

zTOCSY

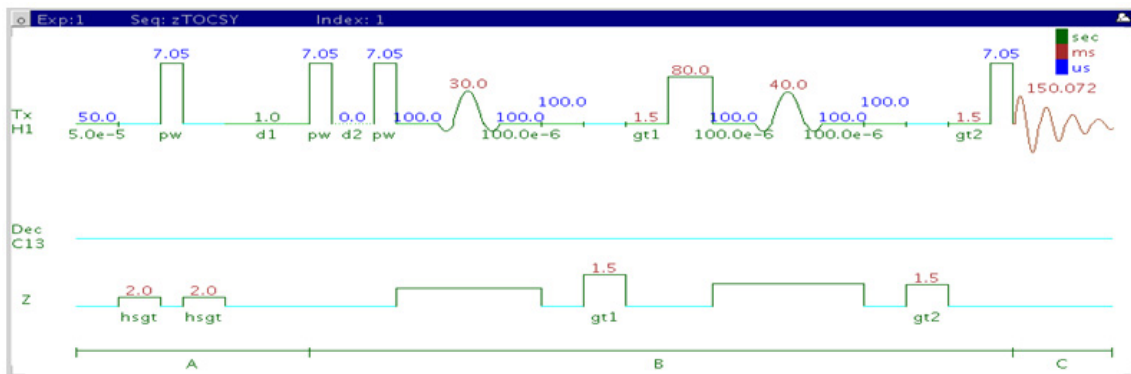

General description and usage

Description:

Two Dimensional total J-correlation spectroscopy for scalar coupled spin systems with a zero-quantum filter for artifact suppression.

Usage:

This experiment produces a 2-dimensional spectrum with peaks along the diagonal corresponding to the peaks in a 1D PROTON and crosspeaks potentially between all protons in a scalar coupled spin system. This experiment is useful for assignment, particularly for complex molecules with multiple overlapping spin systems, for example, peptides. For structure elucidation, the molecular fragments containing individual spin systems can be mapped out from the correlations. The zTOCSY is a highly robust experiment and, along with gCOSY, is among the most sensitive of the 2Ds, making it a popular choice for the organic chemistry NMR lab. All parameters are set from the "Acquire" tab/"Defaults" panel unless otherwise specified.

Key parameters

Parameter	Description
Spectral Width (sw)	Set from previously acquired PROTON*
Acquisition time (at)	Set from "Pulse Sequence" panel, controls the resolution in F2, default 0.15s
Scans per t1 increment (nt)	Select typical choices from pull down menu*
t1 Increments (ni)	Select typical choices from pull down menu*- controls the resolution in F1 (minimum ~64)
Spinlock Pattern	Pull-down menu on the "Pulse Sequence" panel- DIPSI2 works well for small molecules, DIPSI3 is a good choice for large molecules
Spinlock Duration (mixT)	Select from pull down menu- 80ms work best for large spin systems*
Steady State (ss)	Set from "Pulse Sequence" panel, turn on/off gradient cleanup between scans

NOTE

You can type specific values for these parameters manually in the appropriate boxes on the "Acquisition" or "Pulse Sequence" panels.

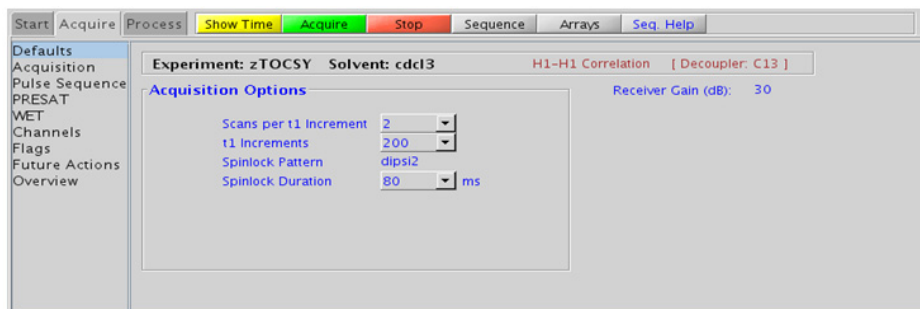

Processing

Automated processing is turned on by default, and the parameters are set to reasonable values, such that the resulting data after the acquisition usually require no further adjustment. The “Process” tab/“Basic” panel contains many of the commonly modified processing parameters, such as a pull-down menu to change the FT data size (1k x 1k is the default), as well as a check box to turn on/off linear prediction and a pull-down to control the extent of linear prediction (default is 2*ni). Menus to quickly change the weighting functions in F2/F1 are also present (defaults are Gaussians). More processing details are found under some of the other “Process” panels, such as the “Default”, “Weighting”, and “More 2D” panels.

Tips, tricks, and next steps

- Spectral width (sw) and receiver gain (gain) settings transfer from a PROTON if the zTOCSY is set up from this experiment.
- The TOCSY is a high sensitivity experiment and data can often be collected using one scan per increment with reasonably concentrated samples. Consider increasing the number of increments (ni) to increase the quality of the data for such samples
- The default number of “steady state” or “dummy scans” that are acquired before data acquisition to establish sample equilibrium is 32, which works for most samples. This value is changed on the “Acquisition” panel of the “Acquire” tab if necessary.
- The spinlock time (in addition to the magnitude of the coupling constants) ultimately controls how far along the spin system the correlations extend. Use spinlock durations exceeding 150ms with caution, as this can result in sample heating. To show primarily vicinal and geminal couplings (such as for a COSY), select a shorter spinlock time, for example, 30ms or less. Such short spinlock zTOCSY is a good alternative to gCOSY as zTOCSY gives pure absorptive lineshape and potentially improved resolution.
- The DIPSI2 spinlock pattern is a good choice for small molecules, and the DIPSI3 is typically used for larger molecules

- The default parameters use a Grad-90-Grad steady state between scans, which helps cleanup unrelaxed magnetization. This can result in much cleaner spectra, especially when using shorter acquisition times, and d1 relaxation delays (defaults are 0.15s and 1s, respectively).
- The zTOCSY experiment contains a zero-quantum filter and usually results in cleaner spectra than the TOCSY experiment.

References:

J. Cavanaugh, M. Rance, J. Magn. Reson. 96 (1992) 670-678. (TOCSY with DIPSI2)

M. J. Trippleton, J. Keeler, Angew. Chem. Int. Ed. 42 (2003) 3938-3941. (Zero Quantum Suppression)

ROESY

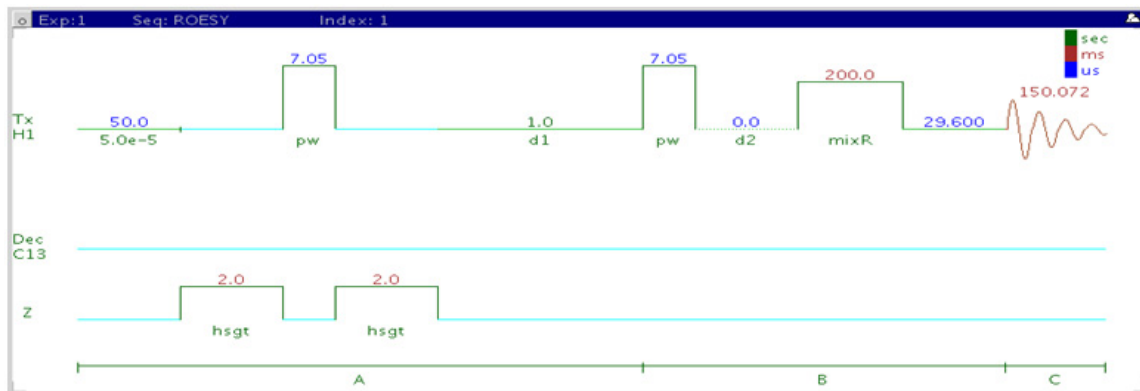

General description and usage

Description:

Two-Dimensional through-space correlation spectroscopy in the rotating frame.

Usage: This experiment produces a 2-dimensional spectrum with peaks along the diagonal corresponding to the peaks in a 1D PROTON and crosspeaks between protons that are close in space (typically $<4 \text{ \AA}$). As such the ROESY experiment is often used to help determine stereochemistry for rigid ring systems or to confirm attachments between proximal, but noncoupled portions of a molecule. The ROESY is the experiment of choice for intermediate-sized molecules (typically between 800-1000 MW) where the NOE can be zero. All parameters are set from the “Acquire” tab/“Defaults” panel unless otherwise specified.

Key parameters

Parameter	Description
Spectral Width (sw)	Set from previously acquired PROTON*
Acquisition time (at)	Set from "Pulse Sequence" panel, controls the resolution in F2, default 0.15s
Scans per t1 increment (nt)	Select typical choices from pull down menu*
t1 Increments (ni)	Select typical choices from pull down menu*- controls the resolution in F1 (minimum ~64)
Relaxation time (d1)	Select typical choices from pull down menu*-controls the delay between scans
Spinlock Pattern	Pull-down menu on "Pulse Sequence" panel- choose troesy (recommended) or cw
Spinlock Mixing time	Select from pull down menu- 200ms works well for most small molecules* DO NOT EXCEED 500ms
Steady State (ss)	Set from "Pulse Sequence" panel, turn on/off gradient cleanup between scans

NOTE

You can type specific values for these parameters manually in the appropriate boxes on the "Acquisition" or "Pulse Sequence" panels.

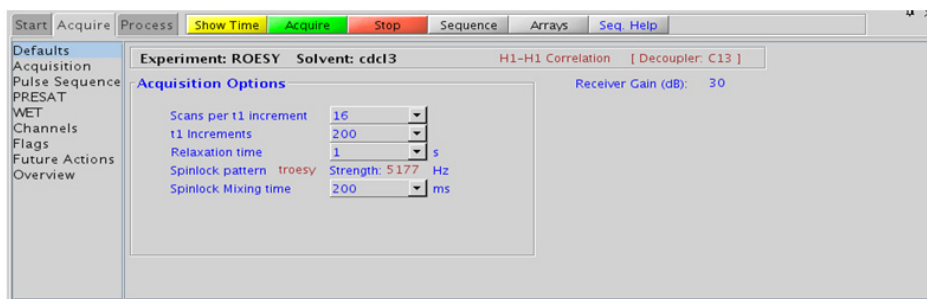

Processing

Automated processing is turned on by default, and the parameters are set to reasonable values, such that the resulting data after the acquisition usually require no further adjustment, except for minor manual phasing changes that can be required as the ROE peaks are negative. The “Process” tab/“Basic” panel contains many of the commonly modified processing parameters, such as a pull-down menu to change the FT data size (1k x 1k is the default), as well as a check box to turn on/off linear prediction and a pull-down to control the extent of linear prediction (default is 2*ni). Menus to quickly change the weighting functions in F2/F1 are also present (defaults are Gaussians). More processing details are found under some of the other “Process” panels, such as the “Default”, “Weighting”, and “More 2D” panels.

Tips, tricks, and next steps

- Spectral width (sw) and receiver gain (gain) settings transfer from a PROTON if the ROESY is set up from this experiment.
- The default number of “steady state” or “dummy scans” that are acquired before data acquisition to establish sample equilibrium is 32, which works for most samples. This value is changed on the “Acquisition” panel of the “Acquire” tab if necessary.
- The default parameters use a Grad-90-Grad steady state between scans, which helps cleanup unrelaxed magnetization. This can result in much cleaner spectra, especially when using shorter acquisition times, and d1 relaxation delays (defaults are 0.15s and 1s, respectively).
- A mixing time of 200ms is a good starting place for most small molecules. Weak ROE interactions can require longer mixing times (up to ~500ms), but keep the mixing time shorter as longer spinlocks can result in sample heating. It is a good idea not to exceed a 500ms spinlock.

- Because the mixing time for the ROESY is limited, weaker correlations may not be observable. ROESY is the experiment of choice over NOESY for medium-sized molecules (MW ~800-1000 depending on the molecule and spectrometer frequency), as they can exhibit zero or very small NOEs. Consider running NOESY experiments (which can be run with longer mixing times) by (i) choosing a more viscous solvent such as d_6 -DMSO or d_6 -DMSO with ~10 - 20% D_2O (which results in slower molecular tumbling and hence generates a positive NOE enhancement like larger molecules), (ii) selecting a lower temperature (if the solvent allows it), or (iii) running the experiment on a spectrometer with higher field strength (if available).
- Crosspeaks in the ROESY spectrum that have the same phase as the diagonal can arise from chemical exchange during the ROE mixing time or TOCSY-type correlations (couplings). The exchange crosspeaks provide information about interconverting molecular conformations and can be used to recognize such molecular dynamic processes.
- The ROESYAD experiment uses adiabatic pulses for the spinlock, which may be preferred over the ROESY.

References:

- A. A. Bothner-By, R. L. Stephens, J. Lee, C. D. Warren, J. W. Jeanloz, J. Am. Chem. Soc. 106 (1984) 811-813. (CAMELSPIN)
- A. Bax, D. G. Davis, J. Magn. Reson. 63 (1985) 207-213. (ROESY)
- T. L. Hwang, A. J. Shaka, J. Am. Chem. Soc 114 (1992) 3157-3159. (EASY-ROESY)

ROESYAD

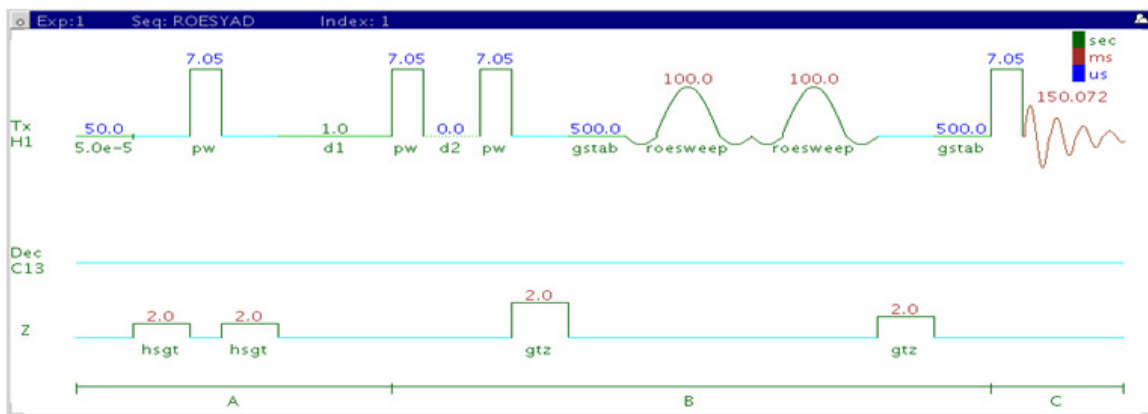

General description and usage

Description:

Two-Dimensional through-space correlation spectroscopy in the rotating frame with adiabatic pulses for the spinlock.

Usage:

This experiment produces a 2-dimensional spectrum with peaks along the diagonal corresponding to the peaks in a 1D PROTON and crosspeaks between protons that are close in space (typically $<4 \text{ \AA}$). As such the ROESYAD experiment is often used to help determine stereochemistry for rigid ring systems or to confirm attachments between proximal, but noncoupled portions of a molecule. The ROESYAD is the experiment of choice for intermediate-sized molecules (typically between 800-1000 MW) where the NOE can be zero. Because of its lower-power adiabatic spinlock the ROESYAD is usually superior to the traditional ROESY experiment. All parameters are set from the "Acquire" tab/"Defaults" panel unless otherwise specified.

Key parameters

Parameter	Description
Spectral Width (sw)	Set from previously acquired PROTON*
Acquisition time (at)	Set from "Pulse Sequence" panel, controls the resolution in F2, default 0.15s
Scans per t1 increment (nt)	Select typical choices from pull down menu*
t1 Increments (ni)	Select typical choices from pull down menu*- controls the resolution in F1 (minimum ~64)
Relaxation time (d1)	Select typical choices from pull down menu*-controls the delay between scans
Spinlock Mixing time	Select from pull down menu- 200ms works well for most small molecules*
Steady State (ss)	Set from "Pulse Sequence" panel, turn on/off gradient cleanup between scans

NOTE

You can type specific values for these parameters manually in the appropriate boxes on the "Acquisition" or "Pulse Sequence" panels.

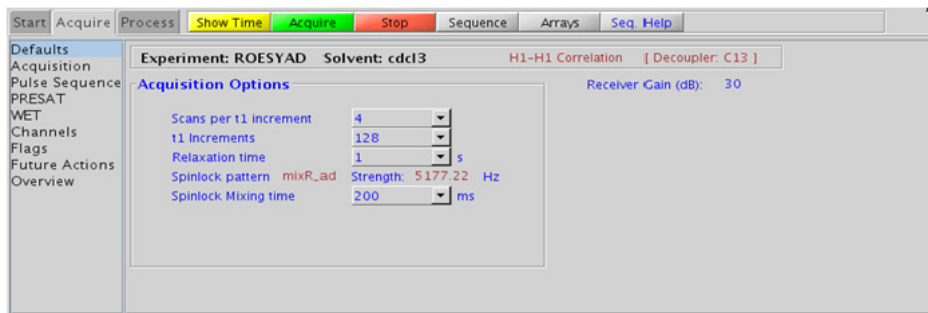

Processing

Automated processing is turned on by default, and the parameters are set to reasonable values, such that the resulting data after the acquisition usually require no further adjustment, except for minor manual phasing changes that can be required, as the ROE peaks are negative. The “Process” tab/“Basic” panel contains many of the commonly modified processing parameters, such as a pull-down menu to change the F_T data size (1k x 1k is the default), as well as a check box to turn on/off linear prediction and a pull-down to control the extent of linear prediction (default is 2**n*_i). Menus to change the weighting functions in F₂/F₁ are also present (defaults are Gaussians). More processing details are found under some of the other “Process” panels, such as the “Default”, “Weighting”, and “More 2D” panels.

Tips, tricks, and next steps

- Spectral width (sw) and receiver gain (gain) settings transfer from a PROTON if the ROESYAD is set up from this experiment.
- The default parameters use a Grad-90-Grad steady state between scans, which helps cleanup unrelaxed magnetization. This can result in much cleaner spectra, especially when using shorter acquisition times, and d1 relaxation delays (defaults are 0.15s and 1s, respectively).
- A mixing time of 200ms is a good starting place for most small molecules. Weak ROE interactions can require longer mixing times (up to ~500ms), but keep the mixing time shorter as longer spinlocks can result in sample heating. It is a good idea not to exceed a 500ms spinlock.

- Because the mixing time for the ROESYAD is limited, weaker correlations may not be observable. ROESYAD is the experiment of choice over NOESY for medium-sized molecules (MW ~800-1000 depending on the molecule and spectrometer frequency), as they can exhibit zero or very small NOEs. Consider running NOESY experiments (which can be run with longer mixing times) by (i) choosing a more viscous solvent such as d_6 -DMSO or d_6 -DMSO with ~10 - 20% D_2O (which results in slower molecular tumbling and hence generates a positive NOE enhancement like larger molecules), (ii) selecting a lower temperature (if the solvent allows it), or (iii) running the experiment on a spectrometer with higher field strength (if available).
- Crosspeaks in the ROESYAD spectrum that have the same phase as the diagonal can arise from chemical exchange during the ROE mixing time or TOCSY-type correlations (couplings). The exchange crosspeaks provide information about interconverting molecular conformations and can be used to recognize such molecular dynamic processes.
- The ROESYAD experiment uses adiabatic pulses for the spinlock, which may be preferred over the ROESY.

References:

- A. Bax, D. G. Davis, J. Magn. Reson. 63 (1985) 207-213. (ROESY)
- T. L. Hwang, A. J. Shaka, J. Am. Chem. Soc 114 (1992) 3157-3159. (EASY-ROESY)
- D. F. Hansen, L. E. Kay, J. Biomol. NMR, 37 (2007) 245-255. (Adiabatic Spinlock)

NOESY

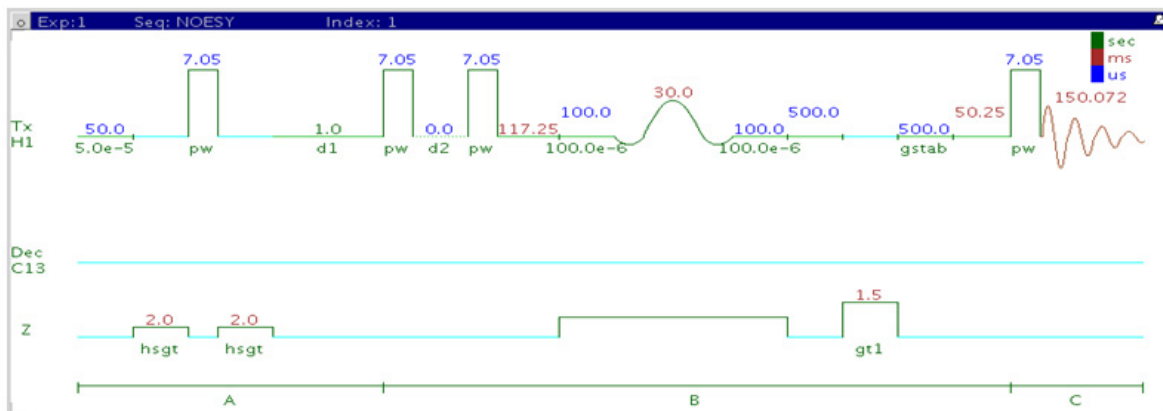

General description and usage

Description:

Two-dimensional through-space correlation spectroscopy.

Usage:

This experiment produces a 2-dimensional spectrum with peaks along the diagonal corresponding to the peaks in a 1D PROTON and crosspeaks between protons that are close in space (typically $<5 \text{ \AA}$). As such the NOESY experiment is often used to help determine stereochemistry for rigid ring systems or to confirm attachments between proximal, but noncoupled portions of a molecule. All parameters are set from the "Acquire" tab/"Defaults" panel unless otherwise specified.

Key parameters

Parameter	Description
Spectral Width (sw)	Set from previously acquired PROTON*
Acquisition time (at)	Set from "Pulse Sequence" panel, controls the resolution in F2, default 0.15s
Scans per t1 increment (nt)	Select typical choices from pull down menu*
t1 Increments (ni)	Select typical choices from pull down menu*- controls the resolution in F1 (minimum ~64)
Relaxation time (d1)	Select typical choices from pull down menu*-controls the delay between scans
NOE Mixing time (mixT)	Select from pull down menu- 500ms works well for most small molecules*
Steady State (ss)	Set from "Pulse Sequence" panel, turn on/off gradient cleanup between scans
ZQ filter	Check box on the "Pulse Sequence" panel- zero-quantum filter for artifact suppression. Strongly recommended- default is on.

NOTE

You can type specific values for these parameters manually in the appropriate boxes on the "Acquisition" or "Pulse Sequence" panels.

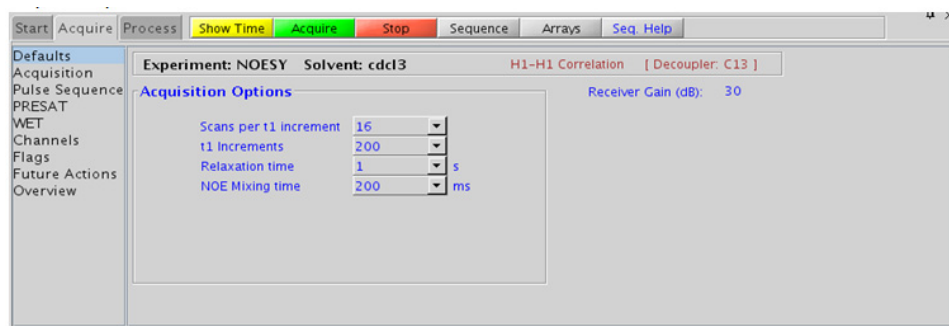

Processing

Automated processing is turned on by default, and the parameters are set to reasonable values, such that the resulting data after the acquisition usually require no further adjustment, except for minor manual phasing changes that can be required, as the NOE peaks are negative for smaller molecules. The “Process” tab/“Basic” panel contains many of the commonly modified processing parameters, such as a pull-down menu to change the FT data size (1k x 1k is the default), as well as a check box to turn on/off linear prediction and a pull-down to control the extent of linear prediction (default is 2*ni). Menus to change the weighting functions in F2/F1 are also present (defaults are Gaussians). More processing details are found under some of the other “Process” panels, such as the “Default”, “Weighting”, and “More 2D” panels.

Tips, tricks, and next steps

- Spectral width (sw) and receiver gain (gain) settings transfer from a PROTON if the NOESY is set up from this experiment.
- The default number of “steady state” or “dummy scans” that are acquired before data acquisition to establish sample equilibrium is 32, which works for most samples. This value is changed on the “Acquisition” panel of the “Acquire” tab if necessary.
- The default parameters use a Grad-90-Grad steady state between scans, which helps cleanup unrelaxed magnetization. This can result in much cleaner spectra, especially when using shorter acquisition times, and d1 relaxation delays (defaults are 0.15s and 1s, respectively).
- A mixing time of 500ms is a good starting place for most small molecules. Very small molecules and/or weak NOE interactions can require longer mixing times (up to ~1s). Longer mixing times, however, increase the possibility of spin diffusion for larger molecules, a situation where the magnetization is transferred through space, and then through coupling, resulting in spurious correlations between protons. The NOE correlation can be confirmed by acquiring a build-up curve, whereby the mixing time is slowly increased in 50-100ms increments until the NOE intensity ceases to increase, and levels off. This time is the optimal mixing time.

- Medium-sized molecules (MW ~500 depending on the molecule and spectrometer frequency) can exhibit zero or very small NOEs. Consider acquiring a ROESYAD for these molecules. Alternatively consider, (i) choosing a more viscous solvent such as d_6 -DMSO or d_6 -DMSO with ~10 - 20% D_2O (which results in slower molecular tumbling and hence generates a positive NOE enhancement like larger molecules), (ii) selecting a lower temperature (if the solvent allows it), or (iii) running the experiment on a spectrometer with higher field strength (if available).
- Small molecules can have crosspeaks arising from chemical exchange during the NOE mixing time and have the same phase as the diagonal. The exchange crosspeaks provide information about interconverting molecular conformations and can be used to recognize such molecular dynamic processes.

References:

S. Macura, Y. Huang, D. Suter, R. R. Ernst, J. Magn. Reson. 43 (1981) 259-281. (NOESY)

M. J. Trippleton, J. Keeler, Angew. Chem. Int. Ed. 42 (2003) 3938-3941. (Zero Quantum Suppression)

3 Homonuclear 2D - (HH)Homo2D zCOSY

zCOSY

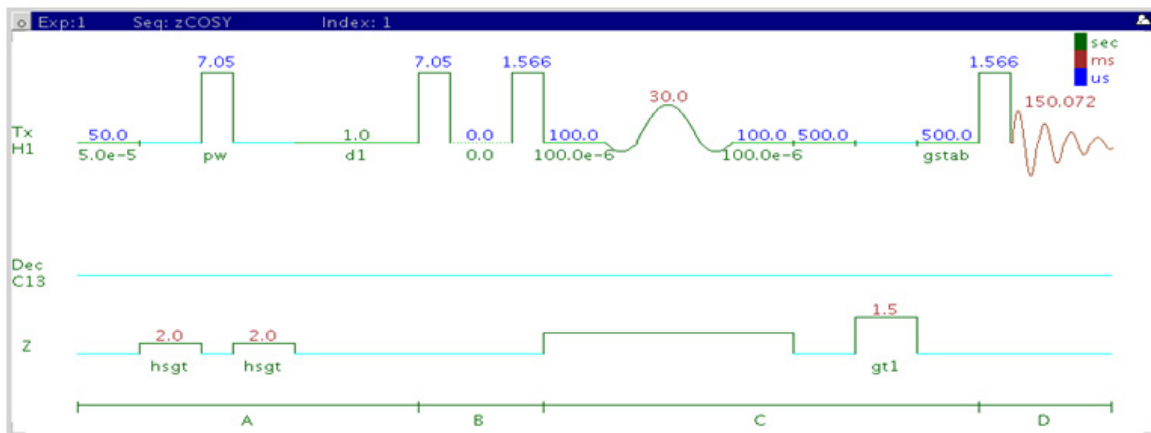

General description and usage

Description:

Two-dimensional J-correlation spectroscopy.

Usage:

This experiment produces a 2-dimensional spectrum with peaks along the diagonal corresponding to the peaks in a 1D PROTON and crosspeaks between protons with nonzero couplings, typically 2 - 4 chemical bonds apart. This experiment is mostly used to determine homonuclear coupling constants, especially smaller long-range couplings. These are typically obstructed by the complex coupling pattern in a traditional COSY but are accessible in zCOSY because of its E.COSY (Exclusive COSY) pattern. For structure elucidation, the protonated molecular fragments can be mapped out from the couplings. All parameters are set from the "Acquire" tab/"Defaults" panel unless otherwise specified.

Key parameters

Parameter	Description
Spectral Width (sw)	Set from previously acquired PROTON*
Acquisition time (at)	Set from "Pulse Sequence" panel, controls the resolution in F2, default 0.15s
Scans per t1 increment (nt)	Select typical choices from pull down menu*
t1 Increments (ni)	Select typical choices from pull down menu*- controls the resolution in F1 (minimum ~64)
Relaxation time (d1)	Select typical choices from pull down menu*-controls the delay between scans
Anti-z COSY	Check box to acquire an anti-z COSY (broadband proton decoupled)
Steady State (ss)	Set from "Pulse Sequence" panel, turn on/off gradient cleanup between scans

NOTE

You can type specific values for these parameters manually in the appropriate boxes on the "Acquisition" panel.

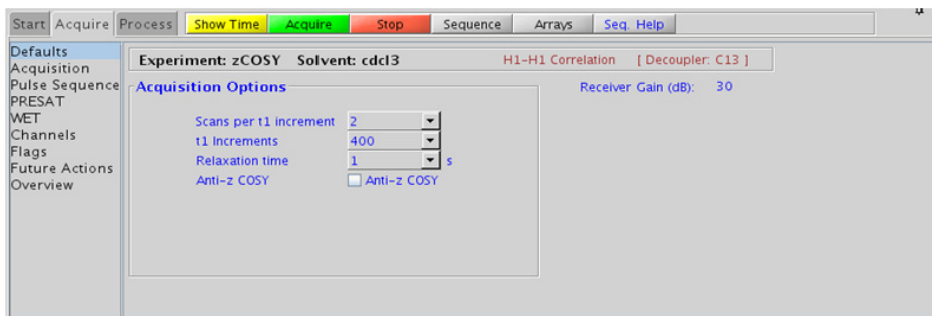

Processing

Automated processing is turned on by default, and the parameters are set to reasonable values, such that the resulting data after the acquisition usually require no further adjustment. The “Process” tab/“Basic” panel contains many of the commonly modified processing parameters, such as a pull-down menu to change the FT data size (1k x 1k is the default), as well as a check box to turn on/off linear prediction and a pull-down to control the extent of linear prediction (default is 2*ni). Menus to change the weighting functions in F2/F1 are also present (defaults are sinebells). More processing details are found under some of the other “Process” panels, such as the “Default”, “Weighting”, and “More 2D” panels.

Tips, tricks, and next steps

- Spectral width (sw) and receiver gain (gain) settings transfer from a PROTON if the zCOSY is set up from this experiment.
- The default number of “steady state” or “dummy scans” that are acquired before data acquisition to establish sample equilibrium is 32, which works for most samples. This value is changed on the “Acquisition” panel of the “Acquire” tab if necessary.
- The default parameters use a Grad-90-Grad steady state between scans, which helps cleanup unrelaxed magnetization. This can result in much cleaner spectra, especially when using shorter acquisition times, and d1 relaxation delays (defaults are 0.15s and 1s, respectively).
- The zCOSY is an attractive alternative to the traditional E.COSY (Exclusive COSY) experiment. zCOSY gives the same crosspeak pattern as E.COSY but can be run with single scan per increment.

References:

W. P. Aue, J. Karhan, R. R. Ernst, J. Chem. Phys. 64 (1976) 4226-4227.
(COSY)

M. J. Trippleton, J. Keeler, Angew. Chem. Int. Ed. 42 (2003) 3938-3941.
(Zero Quantum Suppression)

3 **Homonuclear 2D - (HH)Homo2D** Tips, tricks, and next steps



4 Heteronuclear 2D 1-bond - J1(CH)corr

J1(CH)corr Tab	134
HSQCAD	136
gHSQCAD	140
HSQC	146
gHSQC	150
HMQC	154
gHMQC	158
HETCOR	162
gHETCOR	166
ASAPHMQC	170



J1(CH)corr Tab

This tab of the experiment selector contains 2D experiments for correlating directly attached protons to carbons. HSQC and its variants are the most commonly used family, as they typically provide the best sensitivity and peak shape. These experiments are available both with and without gradient coherence selection and adiabatic 180° carbon pulses. The gradient coherence selected versions of the experiments experience better artifact suppression at the expense of losses of sensitivity (factor of ~ 1.4). The adiabatic versions, HSQCAD and gHSQCAD are highly recommended, as they provide more uniform inversion profiles for a wide ^{13}C spectral width, and, at the same time, compensate for any ^{13}C pwx imperfections in the 180° pulses. Gradient and non-gradient HMQC experiments are also available, as well as a “fast” experiment called ASAPHMQC, which can provide a complete HX correlation spectrum with reasonable resolution in about a minute or less for samples of $\sim 40\text{mM}$ concentration. Finally, there are both gradient and non-gradient versions of the ^{13}C -detected HETCOR experiment. The HSQC and HETCOR experiment (and their variants) also support multiplicity-editing, where signals from the methylene group appear with opposite sign from the signals arising from methyl and methine groups. Note that although the default parameters for these experiments are setup for ^1H - ^{13}C correlations, other X-nuclei may be used instead of carbon provided the appropriate calibrations for these nuclei are in the probe file.

The 1-bond proton-carbon correlation is extremely useful for structure confirmation and elucidation. Peak assignments are easily made from this data; if a particular carbon assignment is known, its attached proton assignment can be derived, and vice versa. Knowledge gained from carbon chemical shift prediction can also be applied to the proton assignments with this type of data. The proton-detected experiments, HSQC and HMQC, are also considerably more sensitive than a 1D CARBON and thus permit access to carbon data for much less concentrated samples.

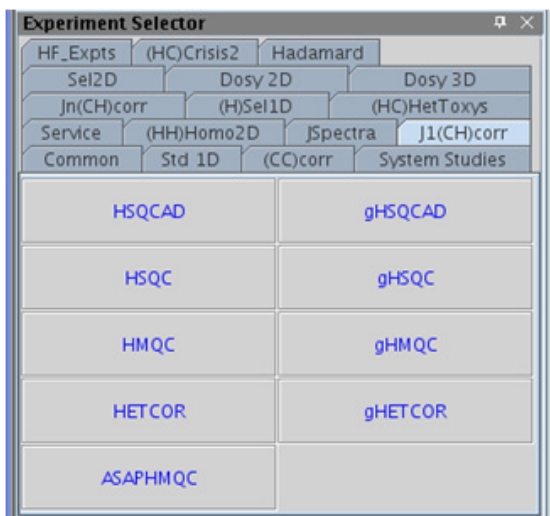

HSQCAD

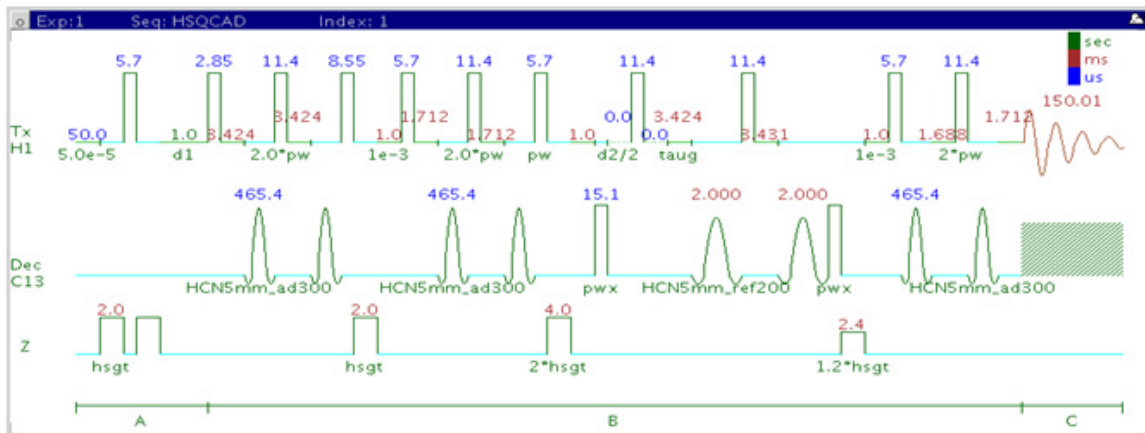

General description and usage

Description:

Two dimensional heteronuclear single-quantum 1-bond J-correlation spectroscopy with adiabatic 180° X-nuclei pulses.

Usage:

The HSQCAD experiment is used to acquire a 2-dimensional spectrum to correlate protons with directly attached carbons. The experiment is very useful for proton and carbon assignments, because if the proton assignment is known, the carbon assignment can be deduced directly from this data and *vice versa*. For structure elucidation, carbon chemical shifts are particularly useful as they are highly sensitive to local functional groups and can be more reliably predicted. All parameters are set from the “Acquire” tab/”Defaults” panel unless otherwise specified.

Key parameters

Parameter	Description
Spectral Width (sw)	Set from previously acquired PROTON*
Acquisition time (at)	Set from "Pulse Sequence" panel, controls the resolution in F2, default 0.15s
F1 Nucleus (dn)	Pull- down menu to set F1 nucleus to ^{13}C , ^{15}N , or other*
C13 Spectral Width (ppm)	Type in desired chemical shift range for F1 dimension
Scans per t1 increment (nt)	Select typical choices from pull down menu*
t1 Increments (ni)	Select typical choices from pull down menu*- controls the resolution in F1 (minimum ~64)
One-Bond J1xh (j1xh)	Set value for the average $^1J_{\text{X,H}}$ - 146 Hz works well for many carbons
H1-C13 Multiplicity Editing	Check box to turn on/off multiplicity editing
Steady State (ss)	Set from "Pulse Sequence" panel, turn on/off gradient cleanup between scans
C12-H1 suppression	Set from "Pulse Sequence" panel- controls type of ^{12}C suppression- default is TANGO-Gradient (highly recommended)

NOTE

You can type specific values for these parameters manually in the appropriate boxes on the "Acquisition" or "Pulse Sequence" panels.

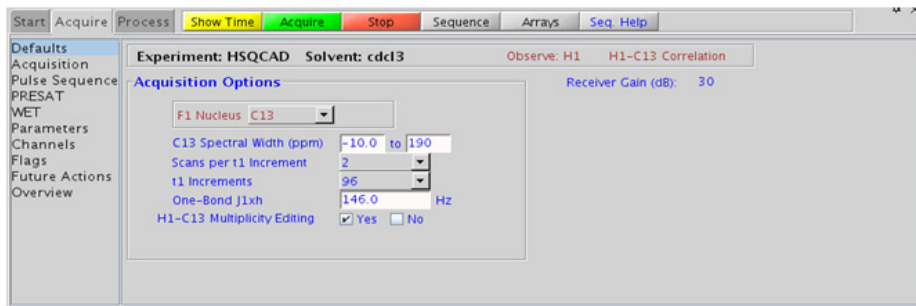

Processing

Automated processing is turned on by default, and the parameters are set to reasonable values such that the resulting data after the acquisition usually require no further adjustment. The “Process” tab/“Basic” panel contains many of the commonly modified processing parameters, such as a pull-down menu to change the FT data size (1k x 1k is the default), as well as a check box to turn on/off linear prediction and a pull-down to control the extent of linear prediction (default is 4*ni). Menus to quickly change the weighting functions in F2/F1 are also present (defaults are gaussians). More processing details can be found under some of the other “Process” panels, such as the “Default”, “Weighting”, and “More 2D” panels.

Tips, tricks, and next steps

- Spectral width (sw) setting transfers from a PROTON if the HSQCAD is set up from this experiment. Receiver gain (gain) is usually set to a high value (≥ 30), unless the sample is extremely concentrated or ^{13}C -labelled.
- To measure ^1H - ^{13}C (or ^1H -X) coupling constants, the carbon decoupling can be turned off by entering “nnn” in the Channel 2 “Dec On/Off” entry on the “Channels” panel or alternatively by typing dm='nnn' on the command line.
- The default number of steady state scans (ss) that are acquired before data acquisition to establish sample equilibrium is 32, which works for most samples. However, higher power carbon decoupling may cause some perturbations that may necessitate more ss scans to reach equilibrium. This value is changed on the “Acquisition” panel of the “Acquire” tab if necessary.
- The default parameters use a Grad-90-Grad steady state between scans, which helps cleanup un-relaxed magnetization. This results in cleaner spectra, especially when using shorter acquisition times (at) and relaxation delays (d1) (defaults are 0.15s and 1s, respectively).

- Using the multiplicity editing feature results in a spectrum with the peaks from methylene-type carbons having the opposite phase to methyl and methine-type carbons. The experiment uses the CRISIS technique to minimize sensitivity loss due to unmatched coupling constants and echo time. CRISIS based multiplicity editing is on by default.
- The multiplicity-editing feature uses the CRISIS technique that relies on a hypothetical relationship between one-bond coupling constant and carbon chemical shift. Carbons with coupling constants that deviate significantly from this relationship (for example cyclopropanes or ethylene oxides) result in imperfect editing.
- In general, the HSQC-type experiments provide spectra with narrower peaks shapes (by suppressing ^1H - ^1H homonuclear coupling modulation in F1) than the HMQC-types, leading to typically better S/N and resolution.
- The HSQCAD experiment has a sensitivity advantage (factor of ~ 1.4) over the gHSQCAD, but due to t1 noise from strong signals such as t-butyl, may produce potentially less clean spectra than its gradient counterpart.
- The HSQCAD uses adiabatic 180° carbon pulses and often gives better results than the HSQC, due to much improved uniform inversion over a wide ^{13}C spectral width.
- Datasets with moderate S/N are better processed with 2*ni linear prediction instead of the default (4*ni). Remember to reset the window function along F1 axis if linear prediction parameters are changed.

References:

G. Bodenhausen, D. J. Ruben, Chem. Phys. Lett. 69 (1980) 185-189.
(HSQC)

E. Kupce, R. Freeman, J. Magn. Reson. Ser. A 117 (1995) 246-256.
(Adiabatic Pulses)

R. D. Boyer, R. Johnson, K. Krishnamurthy, J. Magn. Reson. 165 (2003)
253-259 (HSQCAD / CRISIS-HSQC)

4 Heteronuclear 2D 1-bond - J1(CH)corr gHSQCAD

gHSQCAD

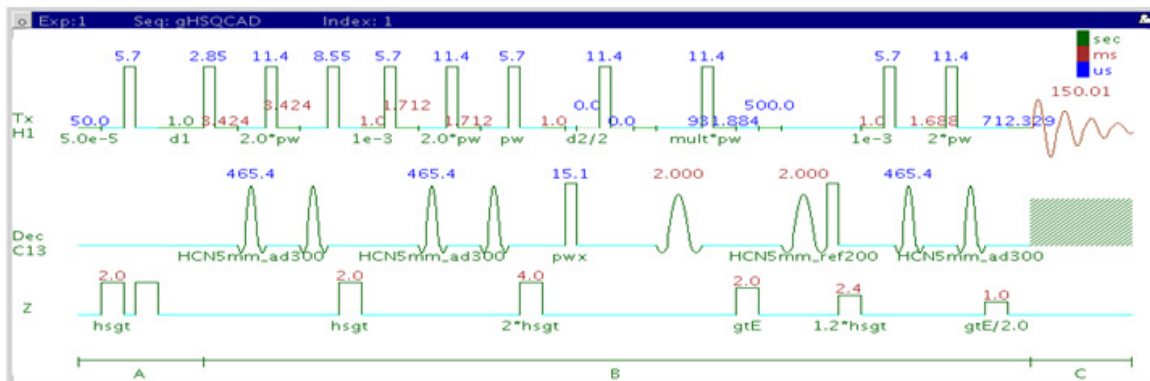

General description and usage

Description:

Two dimensional heteronuclear single-quantum 1-bond J-correlation spectroscopy with adiabatic 180° X-nuclei pulses and gradient coherence selection.

Usage:

The gHSQCAD experiment is used to acquire a 2-dimensional spectrum to correlate protons with directly attached carbons. The experiment is very useful for proton and carbon assignments, because if the proton assignment is known, the carbon assignment can be deduced directly from this data and *vice versa*. For structure elucidation, carbon chemical shifts are particularly useful as they are highly sensitive to local functional groups and can be more reliably predicted. All parameters are set from the “Acquire” tab/“Defaults” panel unless otherwise specified.

Key parameters

Parameters	Description
Spectral Width (sw)	Set from previously acquired PROTON*
Acquisition time (at)	Set from "Pulse Sequence" panel, controls the resolution in F2, default 0.15s
F1 Nucleus (dn)	Pull- down menu to set F1 nucleus to ^{13}C , ^{15}N , or other*
C13 Spectral Width (ppm)	Type in desired chemical shift range for F1 dimension
Scans per t1 increment (nt)	Select typical choices from pull down menu*
t1 Increments (ni)	Select typical choices from pull down menu*- controls the resolution in F1 (minimum ~64)
One-Bond J1xh (j1xh)	Set value for the average $^1J_{\text{X,H}}$ - 146 Hz works well for many carbons
H1-C13 Multiplicity Editing	Check box to turn on/off multiplicity editing
Steady State (ss)	Set from "Pulse Sequence" panel, turn on/off gradient cleanup between scans
C12-H1 suppression	Set from "Pulse Sequence" panel- controls type of ^{12}C suppression- default is TANGO-Gradient (highly recommended)

NOTE

You can type specific values for these parameters manually in the appropriate boxes on the "Acquisition" or "Pulse Sequence" panels.

4 Heteronuclear 2D 1-bond - J1(CH)corr Processing

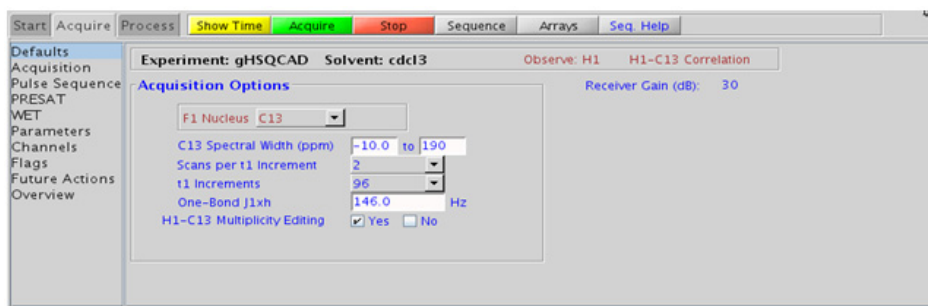

Processing

Automated processing is turned on by default, and the parameters are set to reasonable values such that the resulting data after the acquisition usually require no further adjustment. The “Process” tab/“Basic” panel contains many of the commonly modified processing parameters, such as a pull-down menu to change the FT data size (1k x 1k is the default), as well as a check box to turn on/off linear prediction and a pull-down to control the extent of linear prediction (default is 4*ni). Menus to quickly change the weighting functions in F2/F1 are also present (defaults are gaussians). More processing details are found under some of the other “Process” panels, such as the “Default”, “Weighting”, and “More 2D” panels.

Tips, tricks, and next steps

- Spectral width (sw) setting transfers from a PROTON if the gHSQCAD is set up from this experiment. Receiver gain (gain) is usually set to a high value (≥ 30), unless the sample is extremely concentrated or ^{13}C -labelled.
- To measure ^1H - ^{13}C (or ^1H -X) coupling constants, the carbon decoupling can be turned off by entering “nnn” in the Channel 2 “Dec On/Off” entry on the “Channels” panel or alternatively by typing `dm='nnn'` on the command line.

- The default number of steady state scans (ss) that are acquired before data acquisition to establish sample equilibrium is 32, which works for most samples. However, higher power carbon decoupling may cause some perturbations that may necessitate more ss scans to reach equilibrium. This value is changed on the “Acquisition” panel of the “Acquire” tab if necessary.
- The default parameters use a Grad-90-Grad steady state between scans, which helps cleanup un-relaxed magnetization. This results in cleaner spectra, especially when using shorter acquisition times (at) and relaxation delays (d1) (defaults are 0.15s and 1s, respectively).
- Using the multiplicity editing feature result in a spectrum with the peaks from methylene-type carbons having the opposite phase to methyl and methine-type carbons. The experiment uses the CRISIS technique to minimize sensitivity loss due to unmatched coupling constants and echo time. CRISIS based multiplicity editing is on by default.
- In general, the HSQC-type experiments provide spectra with narrower peaks shapes (by suppressing ^1H - ^1H homonuclear coupling modulation in F1) than the HMQC-types, leading to typically better S/N and resolution.
- The HSQCAD experiment has a sensitivity advantage (factor of ~ 1.4) over the gHSQCAD, but due to t1 noise from strong signals such as t-butyl may produce potentially less clean spectra than its gradient counterpart.
- The gHSQCAD uses adiabatic 180° carbon pulses and often gives better results than the gHSQC, due to much improved uniform inversion over a wide ^{13}C spectral width.
- Datasets with moderate S/N are better processed with 2*ni linear prediction instead of the default (4*ni). Remember to reset the window function along F1 axis if linear prediction parameters are changed.

References:

G. Bodenhausen, D. J. Ruben, Chem. Phys. Lett. 69 (1980) 185-189.
 (HSQC)

E. Kupce, R. Freeman, J. Magn. Reson. Ser. A 117 (1995) 246-256.
 (Adiabatic Pulses)

R. E. Hurd, J. Magn. Reson. 87 (1990) 422-428. (Gradient based Coherence Selection)

4 Heteronuclear 2D 1-bond - J1(CH)corr

Tips, tricks, and next steps

R. D. Boyer, R. Johnson, K. Krishnamurthy, J. Magn. Reson. 165 (2003)
253-259 (gHSQCAD / CRISIS-gHSQC)

HSQC

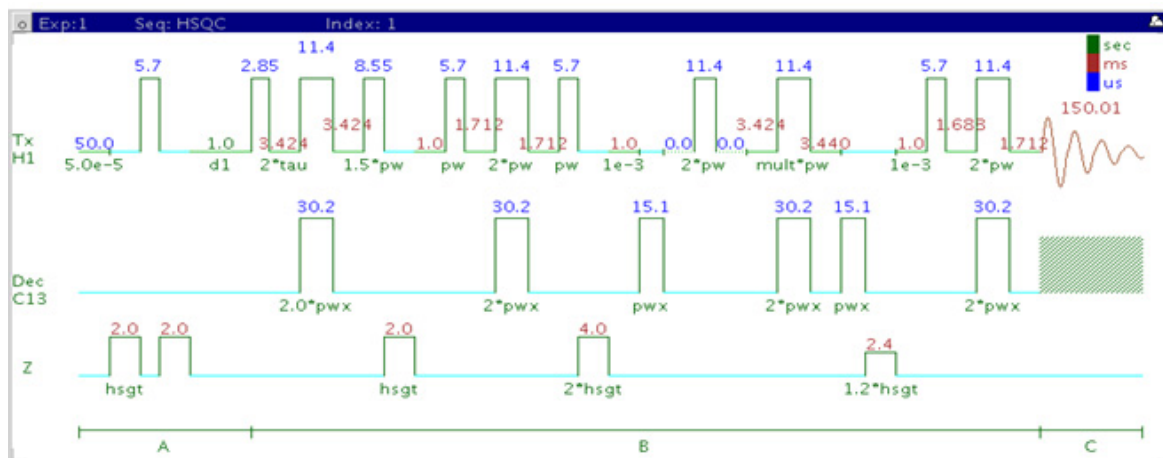

General description and usage

Description:

Two dimensional heteronuclear single-quantum 1-bond J-correlation spectroscopy.

Usage:

The HSQC experiment is used to acquire a 2-dimensional spectrum to correlate protons with directly attached carbons. The experiment is very useful for proton and carbon assignments, because if the proton assignment is known, the carbon assignment can be deduced directly from this data and *vice versa*. For structure elucidation, carbon chemical shifts are particularly useful as they are highly sensitive to local functional groups and can be more reliably predicted. All parameters are set from the "Acquire" tab/"Defaults" panel unless otherwise specified.

Key parameters

Parameter	Description
Spectral Width (sw)	Set from previously acquired PROTON*
Acquisition time (at)	Set from "Pulse Sequence" panel, controls the resolution in F2, default 0.15s
F1 Nucleus (dn)	Pull- down menu to set F1 nucleus to ^{13}C , ^{15}N , or other*
C13 Spectral Width (ppm)	Type in desired chemical shift range for F1 dimension
Scans per t1 increment (nt)	Select typical choices from pull down menu*
t1 Increments (ni)	Select typical choices from pull down menu*- controls the resolution in F1 (minimum ~64)
One-Bond J1xh (j1xh)	Set value for the average $^1J_{\text{X,H}}$ - 146 Hz works well for many carbons
H1-C13 Multiplicity Editing	Check box to turn on/off multiplicity editing
Steady State (ss)	Set from "Pulse Sequence" panel, turn on/off gradient cleanup between scans
C12-H1 suppression	Set from "Pulse Sequence" panel- controls type of ^{12}C suppression- default is TANGO-Gradient (highly recommended)

NOTE

You can type specific values for these parameters manually in the appropriate boxes on the "Acquisition" or "Pulse Sequence" panels.

4 Heteronuclear 2D 1-bond - J1(CH)corr Processing

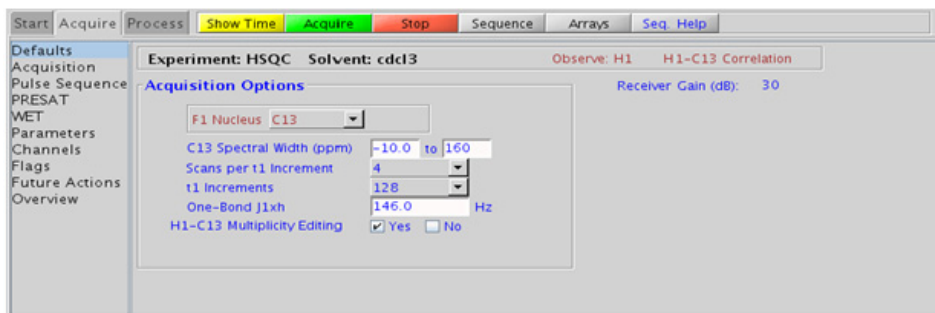

Processing

Automated processing is turned on by default, and the parameters are set to reasonable values such that the resulting data after the acquisition usually require no further adjustment. The “Process” tab/“Basic” panel contains many of the commonly modified processing parameters, such as a pull-down menu to change the FT data size (1k x 1k is the default), as well as a check box to turn on/off linear prediction and a pull-down to control the extent of linear prediction (default is 4*ni). Menus to quickly change the weighting functions in F2/F1 are also present (defaults are gaussians). More processing details are found under some of the other “Process” panels, such as the “Default”, “Weighting”, and “More 2D” panels.

Tips, tricks, and next steps

- Spectral width (sw) setting transfers from a PROTON if the HSQC is set up from this experiment. Receiver gain (gain) is usually set to a high value (≥ 30), unless the sample is extremely concentrated or ^{13}C -labelled.
- To measure ^1H - ^{13}C (or ^1H -X) coupling constants, the carbon decoupling can be turned off by entering “nnn” in the Channel 2 “Dec On/Off” entry on the “Channels” panel or alternatively by typing dm='nnn' on the command line.

- The default number of steady state scans (ss) that are acquired before data acquisition to establish sample equilibrium is 32, which works for most samples. However, higher power carbon decoupling may cause some perturbations that may necessitate more ss scans to reach equilibrium. This value is changed on the “Acquisition” panel of the “Acquire” tab if necessary.
- The default parameters use a Grad-90-Grad steady state between scans, which helps cleanup un-relaxed magnetization. This can result in much cleaner spectra, especially when using shorter acquisition times (at) and relaxation delays (d1) (defaults are 0.15s and 1s, respectively).
- Using the multiplicity editing feature results in a spectrum with the peaks from methylene-type carbons having the opposite phase to methyl and methine-type carbons. There is a sensitivity loss with this feature due to unmatched coupling constants and echo time, but the extra information about multiplicity is usually worth the loss in sensitivity. Hence this feature is on by default. Alternately, consider using HSQCAD to minimize this sensitivity loss.
- In general, the HSQC-type experiments provide spectra with narrower peaks shapes (by suppressing ^1H - ^1H homonuclear coupling modulation in F1) than the HMQC-types, leading to typically better S/N and resolution.
- The HSQC experiment has a sensitivity advantage (factor of ~ 1.4) over the gHSQC, but due to t_1 noise from strong signals such as t-butyl may produce potentially less clean spectra than its gradient counterpart.
- The HSQCAD and gHSQCAD use adiabatic 180° carbon pulses and invariably gives better results than the HSQC.
- Datasets with moderate S/N are better processed with 2^*ni linear prediction instead of the default (4^*ni). Remember to reset the window function along F1 axis if linear prediction parameters are changed.

References:

G. Bodenhausen, D. J. Ruben, Chem. Phys. Lett. 69 (1980) 185-189.
 (HSQC)

A. G. Palmer III, J. Cavanagh, P. E. Wright, M. Rance, J. Magn. Reson. 93 (1991) 151-170. (HSQC)

gHSQC

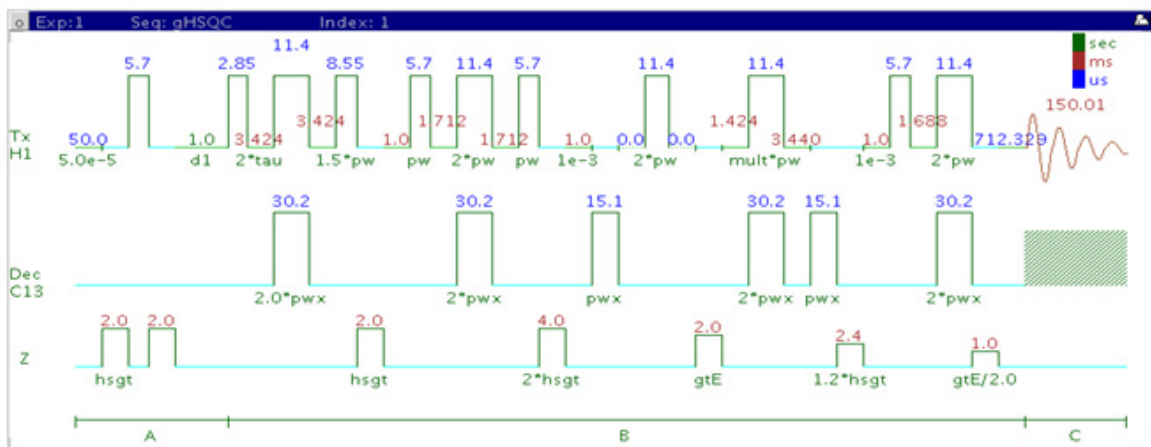

General description and usage

Description:

Two dimensional heteronuclear single-quantum 1-bond J-correlation spectroscopy with gradient coherence selection.

Usage:

The gHSQC experiment is used to acquire a 2-dimensional spectrum to correlate protons with directly attached carbons. The experiment is very useful for proton and carbon assignments, because if the proton assignment is known, the carbon assignment can be deduced directly from this data and *vice versa*. For structure elucidation, carbon chemical shifts are particularly useful as they are highly sensitive to local functional groups and can be more reliably predicted. All parameters are set from the “Acquire” tab/“Defaults” panel unless otherwise specified.

Key parameters

Parameter	Description
Spectral Width (sw)	Set from previously acquired PROTON*
Acquisition time (at)	Set from "Pulse Sequence" panel, controls the resolution in F2, default 0.15s
F1 Nucleus (dn)	Pull- down menu to set F1 nucleus to ^{13}C , ^{15}N , or other*
C13 Spectral Width (ppm)	Type in desired chemical shift range for F1 dimension Scans per t1 increment (nt)
Select typical choices from pull down menu*	
t1 Increments (ni)	Select typical choices from pull down menu* - controls the resolution in F1 (minimum ~64)
One-Bond J1xh (j1xh)	Set value for the average $^1\text{J}_{\text{X,H}}$ - 146 Hz works well for many carbons
H1-C13 Multiplicity Editing	Check box to turn on/off multiplicity editing
Steady State (ss)	Set from "Pulse Sequence" panel, turn on/off gradient cleanup between scans
C12-H1 suppression	Set from "Pulse Sequence" panel- controls type of ^{12}C suppression- default is TANGO-Gradient (highly recommended)

NOTE

You can type specific values for these parameters manually in the appropriate boxes on the "Acquisition" or "Pulse Sequence" panels.

4 Heteronuclear 2D 1-bond - J1(CH)corr Processing

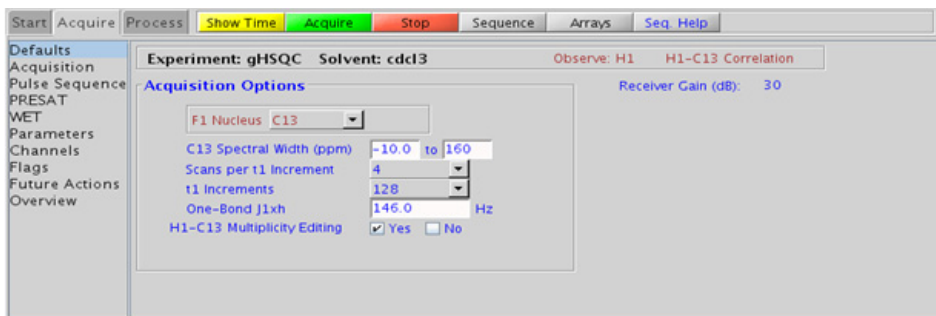

Processing

Automated processing is turned on by default, and the parameters are set to reasonable values, such that the resulting data after the acquisition usually require no further adjustment. The “Process” tab/“Basic” panel contains many of the commonly modified processing parameters, such as a pull-down menu to change the FT data size (1k x 1k is the default), as well as a check box to turn on/off linear prediction and a pull-down to control the extent of linear prediction (default is 4*ni). Menus to quickly change the weighting functions in F2/F1 are also present (defaults are gaussians). More processing details are found under some of the other “Process” panels, such as the “Default”, “Weighting”, and “More 2D” panels.

Tips, tricks, and next steps

- Spectral width (sw) setting transfers from a PROTON if the gHSQC is set up from this experiment. Receiver gain (gain) is usually set to a high value (≥ 30), unless the sample is extremely concentrated or ^{13}C -labelled.
- To measure ^1H - ^{13}C (or ^1H -X) coupling constants, the carbon decoupling can be turned off by entering “nnn” in the Channel 2 “Dec On/Off” entry on the “Channels” panel or alternatively by typing `dm='nnn'` on the command line.

- The default number of steady state scans (ss) that are acquired before data acquisition to establish sample equilibrium is 32, which works for most samples. However, higher power carbon decoupling may cause some perturbations that may necessitate more ss scans to reach equilibrium. This value is changed on the “Acquisition” panel of the “Acquire” tab if necessary.
- The default parameters use a Grad-90-Grad steady state between scans, which helps cleanup un-relaxed magnetization. This can result in much cleaner spectra, especially when using shorter acquisition times (at) and relaxation delays (d1) (defaults are 0.15s and 1s, respectively).
- Using the multiplicity editing feature results in a spectrum with the peaks from methylene-type carbons having the opposite phase to methyl and methine-type carbons. There is a sensitivity loss with this feature due to unmatched coupling constants and echo time, but the extra information about multiplicity is usually worth the loss in sensitivity. Hence this feature is on by default. Alternately, consider using gHSQCAD to minimize this sensitivity loss.
- In general, the HSQC-type experiments provide spectra with narrower peaks shapes (by suppressing ^1H - ^1H homonuclear coupling modulation in F1) than the HMQC-types, leading to typically better S/N and resolution.
- The HSQC experiment has a sensitivity advantage (factor of ~ 1.4) over the gHSQC, but due to t1 noise from strong signals such as t-butyl may produce potentially less clean spectra than its gradient counterpart.
- The HSQCAD and gHSQCAD use adiabatic 180° carbon pulses and invariably give better results than the gHSQC.
- Datasets with moderate S/N are better processed with 2^*ni linear prediction instead of the default (4^*ni). Remember to reset the window function along F1 axis if linear prediction parameters are changed.

References:

G. Bodenhausen, D. J. Ruben, Chem. Phys. Lett. 69 (1980) 185-189.
 (HSQC)

R. E. Hurd, J. Magn. Reson. 87 (1990) 422-428. (Gradient based Coherence Selection)

HMQC

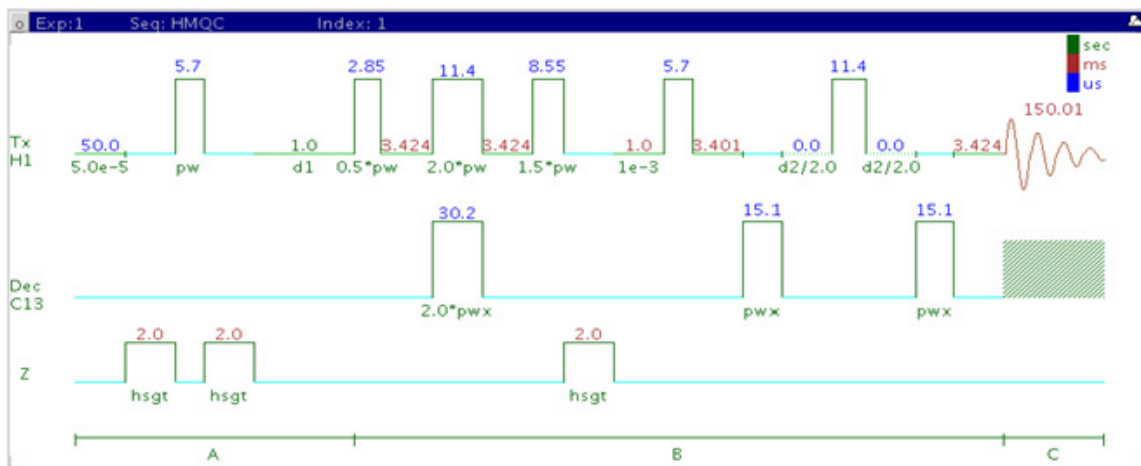

General description and usage

Description:

Two dimensional heteronuclear multiple-quantum 1-bond J-correlation spectroscopy.

Usage:

The HMQC experiment is used to acquire a 2-dimensional spectrum to correlate protons with directly attached carbons. The experiment is very useful for proton and carbon assignments, because if the proton assignment is known, the carbon assignment can be deduced directly from this data and *vice versa*. For structure elucidation, carbon chemical shifts are particularly useful as they are highly sensitive to local functional groups and can be more reliably predicted. All parameters are set from the “Acquire” tab/“Defaults” panel unless otherwise specified.

Key parameters

Parameters	Description
Spectral Width (sw)	Set from previously acquired PROTON*
Acquisition time (at)	Set from "Pulse Sequence" panel, controls the resolution in F2, default 0.15s
F1 Nucleus (dn)	Pull- down menu to set F1 nucleus to ^{13}C , ^{15}N , or other*
C13 Spectral Width (ppm)	Type in desired chemical shift range for F1 dimension
Scans per t1 increment (nt)	Select typical choices from pull down menu*
t1 Increments (ni)	Select typical choices from pull down menu*- controls the resolution in F1 (minimum ~64)
One-Bond J1xh (j1xh)	Set value for the average $^1J_{\text{X,H}}$ - 146 Hz works well for many carbons
Steady State (ss)	Set from "Pulse Sequence" panel, turn on/off gradient cleanup between scans
C12-H1 suppression	Set from "Pulse Sequence" panel- controls type of ^{12}C suppression- default is TANGO-Gradient (highly recommended)

NOTE

You can type specific values for these parameters manually in the appropriate boxes on the "Acquisition" or "Pulse Sequence" panels.

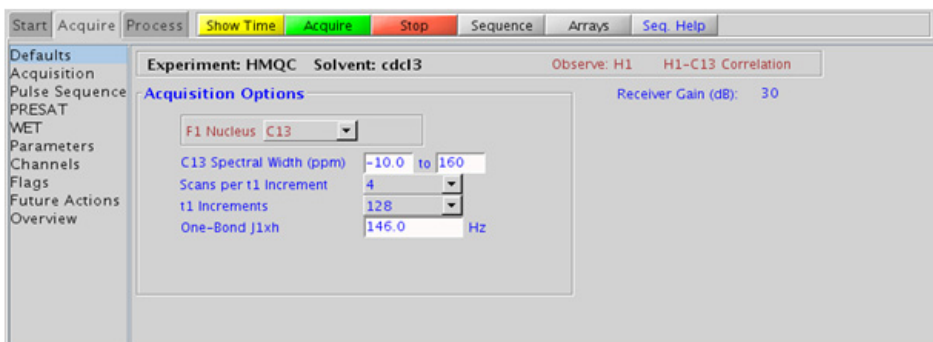

Processing

Automated processing is turned on by default, and the parameters are set to reasonable values, such that the resulting data after the acquisition usually require no further adjustment. The “Process” tab/“Basic” panel contains many of the commonly modified processing parameters, such as a pull-down menu to change the FT data size (1k x 1k is the default), as well as a check box to turn on/off linear prediction and a pull-down to control the extent of linear prediction (default is 4*ni). Menus to quickly change the weighting functions in F2/F1 are also present (defaults are gaussians). More processing details are found under some of the other “Process” panels, such as the “Default”, “Weighting”, and “More 2D” panels.

Tips, tricks, and next steps

- Spectral width (sw) setting transfers from a PROTON if the HMQC is set up from this experiment. Receiver gain (gain) is usually set to a high value (≥ 30), unless the sample is extremely concentrated or ^{13}C -labelled.
- To measure ^1H - ^{13}C (or ^1H -X) coupling constants, the carbon decoupling can be turned off by entering “nnn” in the Channel 2 “Dec On/Off” entry on the “Channels” panel or alternatively by typing dm='nnn' on the command line.
- The default number of steady state scans (ss) that are acquired before data acquisition to establish sample equilibrium is 32, which works for most samples. However, higher power carbon decoupling may cause some perturbations that may necessitate more ss scans to reach equilibrium. This value is changed on the “Acquisition” panel of the “Acquire” tab if necessary.
- The default parameters use a Grad-90-Grad steady state between scans, which helps cleanup un-relaxed magnetization. This can result in much cleaner spectra, especially when using shorter acquisition times (at) and relaxation delays (d1) (defaults are 0.15s and 1s, respectively).
- The HMQC experiment has a sensitivity advantage (factor of ~ 1.4) over the gHMQC, but due to t1 noise from strong signals such as t-butyl may produce potentially less clean spectra than its gradient counterpart.

- In general, the HSQC-type experiments provide spectra with narrower peaks shapes (by suppressing ^1H - ^1H homonuclear coupling modulation in F1) than the HMQC-types, leading to typically better S/N and resolution. In addition, the HSQC experiments have the added ability to do multiplicity- editing.

References:

L. Muller, J. Am. Chem. Soc. 101 (1979) 4481-4484. (HMQC)

A. Bax, R. H. Griffey, B. L. Hawkins, J. Magn. Reson. 55 (1983) 301-315. (HMQC)

4 Heteronuclear 2D 1-bond - J1(CH)corr gHMOC

gHMOC

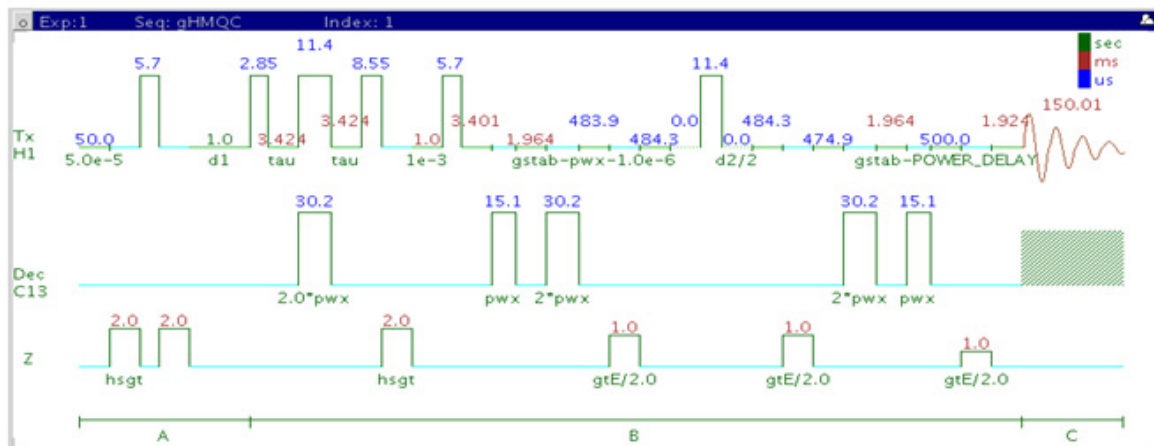

General description and usage

Description:

Two dimensional heteronuclear multiple-quantum 1-bond J-correlation spectroscopy with gradient coherence selection.

Usage:

The gHMOC experiment is used to acquire a 2-dimensional spectrum to correlate protons with directly attached carbons. The experiment is very useful for proton and carbon assignments, because if the proton assignment is known, the carbon assignment can be deduced directly from this data and *vice versa*. For structure elucidation, carbon chemical shifts are particularly useful as they are highly sensitive to local functional groups and can be more reliably predicted. All parameters are set from the "Acquire" tab/"Defaults" panel unless otherwise specified.

Key parameters

Parameters	Description
Spectral Width (sw)	Set from previously acquired PROTON*
Acquisition time (at)	Set from "Pulse Sequence" panel, controls the resolution in F2, default 0.15s
F1 Nucleus (dn)	Pull- down menu to set F1 nucleus to ^{13}C , ^{15}N , or other*
C13 Spectral Width (ppm)	Type in desired chemical shift range for F1 dimension
Scans per t1 increment (nt)	Select typical choices from pull down menu*
t1 Increments (ni)	Select typical choices from pull down menu*- controls the resolution in F1 (minimum ~64)
One-Bond J1xh (j1xh)	Set value for the average $^1J_{\text{X,H}}$ - 146 Hz works well for many carbons
Steady State (ss)	Set from "Pulse Sequence" panel, turn on/off gradient cleanup between scans
C12-H1 suppression	Set from "Pulse Sequence" panel- controls type of ^{12}C suppression- default is TANGO-Gradient (highly recommended)

NOTE

You can type specific values for these parameters manually in the appropriate boxes on the "Acquisition" or "Pulse Sequence" panels.

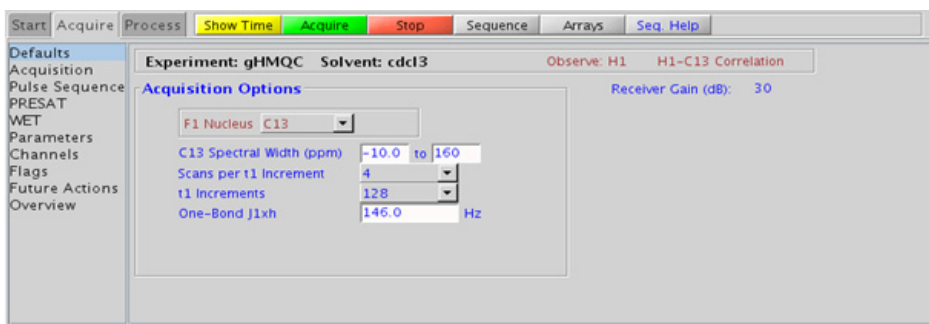

Processing

Automated processing is turned on by default, and the parameters are set to reasonable values, such that the resulting data after the acquisition usually require no further adjustment. The “Process” tab/“Basic” panel contains many of the commonly modified processing parameters, such as a pull-down menu to change the FT data size (1k x 1k is the default), as well as a check box to turn on/off linear prediction and a pull-down to control the extent of linear prediction (default is 4*ni). Menus to quickly change the weighting functions in F2/F1 are also present (defaults are gaussians). More processing details are found under some of the other “Process” panels, such as the “Default”, “Weighting”, and “More 2D” panels.

Tips, tricks, and next steps

- Spectral width (sw) setting transfers from a PROTON if the gHMQC is set up from this experiment. Receiver gain (gain) is usually set to a high value (≥ 30), unless the sample is extremely concentrated or ^{13}C -labelled.
- To measure ^1H - ^{13}C (or ^1H -X) coupling constants, the carbon decoupling can be turned off by entering “nnn” in the Channel 2 “Dec On/Off” entry on the “Channels” panel or alternatively by typing dm='nnn' on the command line.
- The default number of steady state scans (ss) that are acquired before data acquisition to establish sample equilibrium is 32, which works for most samples. However, higher power carbon decoupling may cause some perturbations that may necessitate more ss scans to reach equilibrium. This value is changed on the “Acquisition” panel of the “Acquire” tab if necessary.
- The default parameters use a Grad-90-Grad steady state between scans, which helps cleanup un-relaxed magnetization. This can result in much cleaner spectra, especially when using shorter acquisition times (at) and relaxation delays (d1) (defaults are 0.15s and 1s, respectively).
- The HMQC experiment has a sensitivity advantage (factor of ~ 1.4) over the gHMQC, but due to t1 noise from strong signals such as t-butyl may produce potentially less clean spectra than its gradient counterpart.

- In general, the HSQC-type experiments provide spectra with narrower peaks shapes (by suppressing ^1H - ^1H homonuclear coupling modulation in F1) than the HMQC-types, leading to typically better S/N and resolution. In addition, the HSQC experiments have the added ability to do multiplicity editing.

References:

- L. Muller, J. Am. Chem. Soc. 101 (1979) 4481-4484. (HMQC)
- A. Bax, R. H. Griffey, B. L. Hawkins, J. Magn. Reson. 55 (1983) 301-315. (HMQC)
- R. E. Hurd, J. Magn. Reson. 87 (1990) 422-428. (Gradient based Coherence Selection)

HETCOR

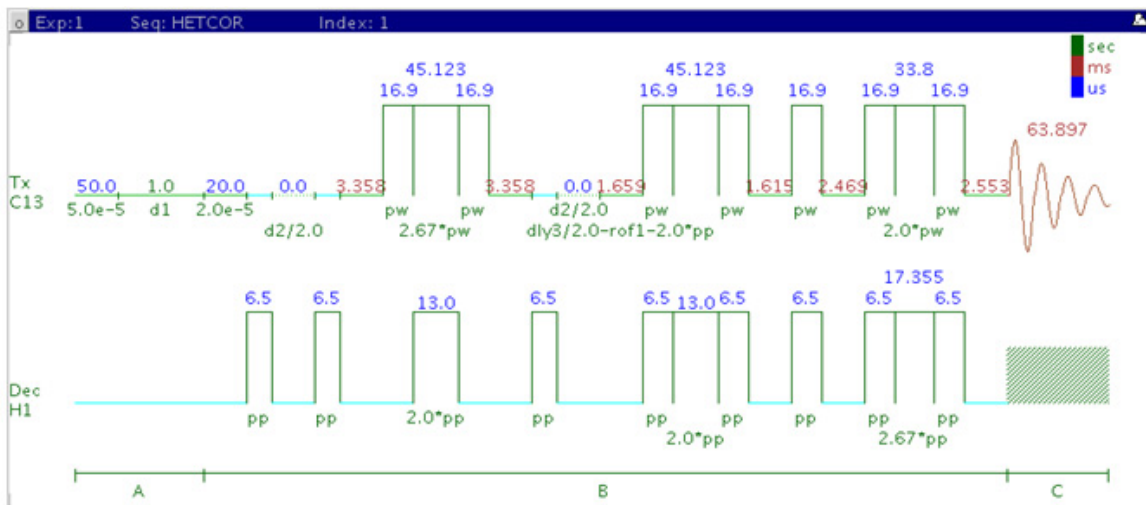

General description and usage

Description:

Two dimensional heteronuclear 1-bond shift correlation with carbon observe.

Usage:

The HETCOR experiment is used to acquire a 2-dimensional spectrum to correlate protons with directly attached carbons. However unlike the HSQC/HMQC experiments HETCOR is carbon-detected, meaning the F1 dimension is ^1H and the F2 dimension is ^{13}C . Because the HETCOR is significantly less sensitive than the proton-detected HSQC/HMQC, use it only under special circumstances where higher resolution is desired in the carbon dimension. The proton decoupling power (during acquisition) used is also usually less. All parameters are set from the “Acquire” tab/“Defaults” panel unless otherwise specified.

Key parameters

Parameter	Description
Spectral Width (sw)	Set from previously acquired CARBON or type in desired values
Acquisition time (at)	Set from "Pulse Sequence" panel, controls the resolution in F2, default 0.064s
Scans per t1 increment (nt)	Select typical choices from pull down menu*
t1 Increments (ni)	Select typical choices from pull down menu*- controls the resolution in F1 (minimum ~64)
One-Bond Coupling	Set value for the average $^1J_{X,H}$ on "Pulse Sequence" panel- 146 Hz works well for many carbons
Steady State (ss)	Set from "Pulse Sequence" panel, turn on/off gradient cleanup between scans

NOTE

You can type specific values for these parameters manually in the appropriate boxes on the "Acquisition" or "Pulse Sequence" panels.

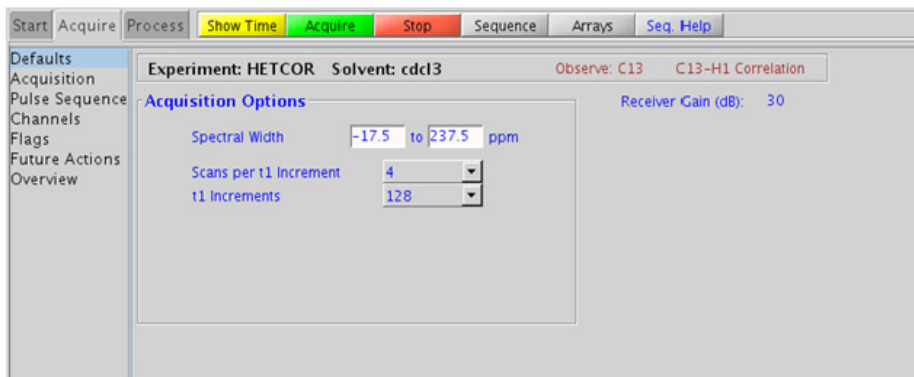

Processing

Automated processing is turned on by default, and the parameters are set to reasonable values, such that the resulting data after the acquisition usually require no further adjustment. The “Process” tab/“Basic” panel contains many of the commonly modified processing parameters, such as a pull-down menu to change the FT data size (2k x 1k is the default), as well as a check box to turn on/off linear prediction and a pull-down to control the extent of linear prediction (default is 4*ni). Menus to quickly change the weighting functions in F2/F1 are also present (defaults are gaussians). More processing details are found under some of the other “Process” panels, such as the “Default”, “Weighting”, and “More 2D” panels.

Tips, tricks, and next steps

- Spectral width (sw) setting transfers from a CARBON if the HETCOR is set up from this experiment. Receiver gain (gain) is usually set to a high value (≥ 30), unless the sample is extremely concentrated or ^{13}C -labelled.
- The default number of steady state scans (ss) that are acquired before data acquisition to establish sample equilibrium is 32, which works for most samples. This value is changed on the “Acquisition” panel of the “Acquire” tab if necessary.
- The default parameters use a Grad-90-Grad steady state between scans, which helps cleanup un-relaxed magnetization. The default setting for this parameter is off.
- The embedded multiplicity- editing results in a spectrum with the peaks from methylene-type carbons having the opposite phase to methyl and methine-type carbons.
- The HETCOR also generates an effective ^1H broadband decoupling along the F1 (H1) dimension.
- The HETCOR experiment has a sensitivity advantage (factor of ~ 1.4) over the gHETCOR, but due to t1 noise from strong signals such as t-butyl, may produce potentially less clean spectra than its gradient counterpart.

- In general, the HSQC-type experiments are far more sensitive than the HETCOR. The advantages to the HETCOR are lower decoupling power and potentially higher resolution for carbon. The band-selective HSQC experiment, (HC)bsHSQCAD (see Chapter 7), however, is a much more sensitive experiment and may provide a more convenient way to achieve higher ^{13}C resolution.

References:

- A. Bax, G. A. Morris, J. Magn. Reson. 42 (1981), 501-505. (HETCOR)
D. L. Turner, Prog. NMR. Spectrosc. 17 (1985) 281-358. (2D NMR)

4 Heteronuclear 2D 1-bond - J1(CH)corr gHETCOR

gHETCOR

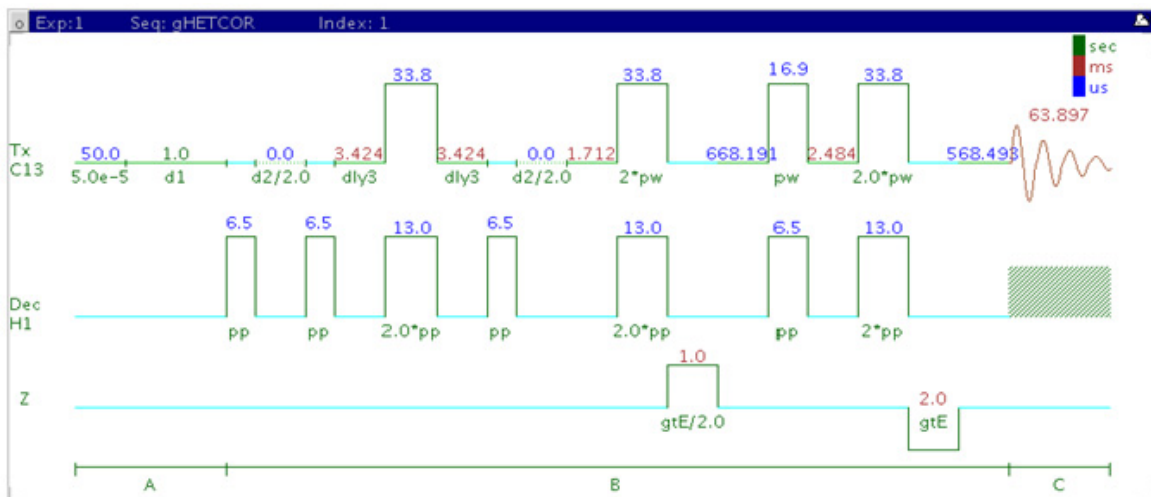

General description and usage

Description:

Two dimensional heteronuclear 1-bond shift correlation with carbon observe and gradient coherence selection.

Usage:

The gHETCOR experiment is used to acquire a 2-dimensional spectrum to correlate protons with directly attached carbons. However unlike the gHSQC/gHMQC experiments gHETCOR is carbon-detected, meaning the F1 dimension is ^1H and the F2 dimension is ^{13}C . Because the gHETCOR is significantly less sensitive than the proton-detected gHSQC/gHMQC, and use it only under special circumstances where higher resolution is desired in the carbon dimension. The proton decoupling power (during acquisition) used is also usually less. All parameters are set from the "Acquire" tab/"Defaults" panel unless otherwise specified.

Key parameters

Parameter	Description
Spectral Width (sw)	Set from previously acquired CARBON or type in desired values
Acquisition time (at)	Set from "Pulse Sequence" panel, controls the resolution in F2, default 0.064s
Scans per t1 increment (nt)	Select typical choices from pull down menu*
t1 Increments (ni)	Select typical choices from pull down menu*- controls the resolution in F1 (minimum ~64)
One-Bond Coupling	Set value for the average $^1J_{X,H}$ on "Pulse Sequence" panel- 146 Hz works well for many carbons
Steady State (ss)	Set from "Pulse Sequence" panel, turn on/off gradient cleanup between scans

NOTE

You can type specific values for these parameters manually in the appropriate boxes on the "Acquisition" or "Pulse Sequence" panels.

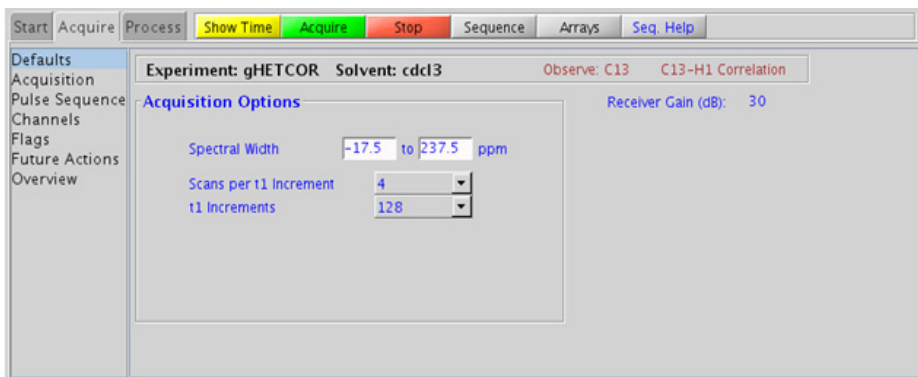

Processing

Automated processing is turned on by default, and the parameters are set to reasonable values, such that the resulting data after the acquisition usually require no further adjustment. The “Process” tab/“Basic” panel contains many of the commonly modified processing parameters, such as a pull-down menu to change the FT data size (2k x 1k is the default), as well as a check box to turn on/off linear prediction and a pull-down to control the extent of linear prediction (default is 4*ni). Menus to quickly change the weighting functions in F2/F1 are also present (defaults are gaussians). More processing details are found under some of the other “Process” panels, such as the “Default”, “Weighting”, and “More 2D” panels.

Tips, tricks, and next steps

- Spectral width (sw) setting transfers from a CARBON if the gHETCOR is set up from this experiment. Receiver gain (gain) is usually set to a high value (≥ 30), unless the sample is extremely concentrated or ^{13}C -labelled.
- The default number of steady state scans (ss) that are acquired before data acquisition to establish sample equilibrium is 32, which works for most samples. This value is changed on the “Acquisition” panel of the “Acquire” tab if necessary.
- The default parameters use a Grad-90-Grad steady state between scans, which helps cleanup un-relaxed magnetization. The default setting for this parameter is off.
- The embedded multiplicity editing results in a spectrum with the peaks from methylene-type carbons having the opposite phase to methyl and methine-type carbons.
- The gHETCOR also generates an effective ^1H broadband decoupling along the F1 (H1) dimension.
- The HETCOR experiment has a sensitivity advantage (factor of ~ 1.4) over the gHETCOR, but due to t1 noise from strong signals from t-butyl, may produce potentially less clean spectra than its gradient counterpart.

- In general, the gHSQC-type experiments are far more sensitive than the gHETCOR. The advantages to the gHETCOR are lower decoupling power and potentially higher resolution for carbon. The band-selective HSQC experiment, (HC)bsgHSQCAD (see Chapter 7), however, is a much more sensitive experiment and may provide a more convenient way to achieve higher ^{13}C resolution.

References:

- A. Bax, G. A. Morris, J. Magn. Reson. 42 (1981), 501-505. (HETCOR)
- D. L. Turner, Prog. NMR. Spectrosc. 17 (1985) 281-358. (2D NMR)
- R. E. Hurd, J. Magn. Reson. 87 (1990) 422-428. (Gradient based Coherence Selection)

ASAPHMQC

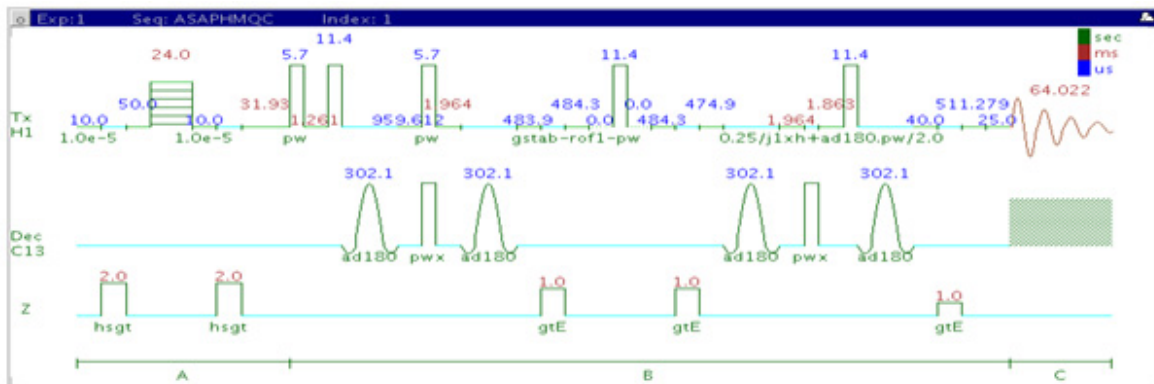

General description and usage

Description:

Two dimensional heteronuclear multiple-quantum 1-bond J-correlation spectroscopy with adiabatic 180° X-nuclei pulses and an “ASAP” feature for rapid recycle times.

Usage:

This experiment is used to acquire a 2-dimensional spectrum to correlate protons with directly attached carbons. The experiment is the most useful of the HMQC series as it contains a feature that allows for very fast recycle time. With a reasonably concentrated sample, it is possible to obtain an ASAPHMQC spectrum with adequate resolution in about 1 minute. For structure elucidation, carbon chemical shifts are particularly useful as they are highly sensitive to local functional groups and can be more reliably predicted. All parameters are set from the “Acquire” tab/“Defaults” panel unless otherwise specified.

Key parameters

Parameter	Description
Spectral Width (sw)	Set from previously acquired PROTON*
Acquisition time (at)	Set from "Pulse Sequence" panel, controls the resolution in F2, default 0.064s for ASAP
F1 Nucleus (dn)	Pull- down menu to set F1 nucleus to ^{13}C , ^{15}N , or other*
C13 Spectral Width (ppm)	Type in desired chemical shift range for F1 dimension
Scans per t1 increment (nt)	Select typical choices from pull down menu*
t1 Increments (ni)	Select typical choices from pull down menu*- controls the resolution in F1
One-Bond J1xh (j1xh)	Set value for the average $^1J_{\text{X,H}}$ - 146 Hz works well for many carbons
ASAP	Check box to turn on/off ASAP feature (off gives an HMQC with adiabatic 180° X-nuclei pulses)
Relaxation time (d1)	Set from "Acquisition" panel- controls the delay between scans (default is 0.064s)
Mixing time (mix)	Set from" Pulse Sequence" panel- mixing time for adiabatic pulses (default is 25ms)
Steady State (ss)	Set from "Pulse Sequence" panel, turn on/off gradient cleanup between scans

NOTE

You can type specific values for these parameters manually in the appropriate boxes on the "Acquisition" or "Pulse Sequence" panels.

4 Heteronuclear 2D 1-bond - J1(CH)corr Processing

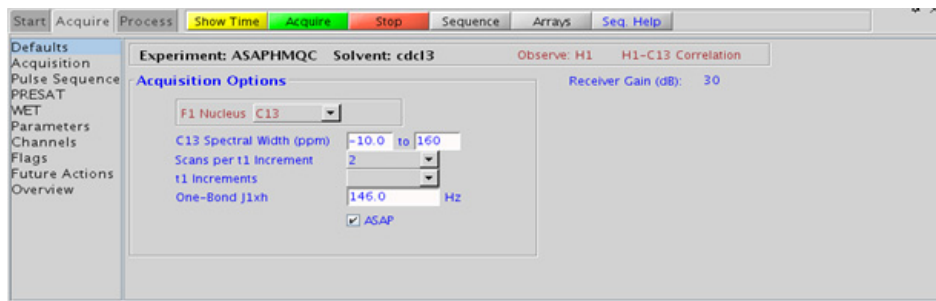

Processing

Automated processing is turned on by default, and the parameters are set to reasonable values, such that the resulting data after the acquisition usually require no further adjustment. The “Process” tab/“Basic” panel contains many of the commonly modified processing parameters, such as a pull-down menu to change the FT data size (1k x 1k is the default), as well as a check box to turn on/off linear prediction and a pull-down to control the extent of linear prediction (default is 4*ni). Menus to quickly change the weighting functions in F2/F1 are also present (defaults are gaussians). More processing details are found under some of the other “Process” panels, such as the “Default”, “Weighting”, and “More 2D” panels.

Tips, tricks, and next steps

- Spectral width (sw) setting transfers from a PROTON if the ASAPHMQC is set up from this experiment. Receiver gain (gain) is usually set to a high value (≥ 30), unless the sample is extremely concentrated or ^{13}C -labelled.
- ASAPHMQC as a fast method gives significantly better sensitivity than other members of the heteronuclear one-bond correlation experiments for a given spectrometer time. This alone overweighs other advantages of traditional experiments.

- During the short relaxation delay (d1), the ASAPHMQC employs a TOCSY-type magnetization transfer from ^{12}C -attached protons (which are kept along z during the pulse sequence) to the observed ^{13}C -attached protons. Note that because of this transfer, the ASAPHMQC works best if one or several protons are in the neighborhood (i.e., spin system) of the observed ^{13}C - ^1H pair. Lone ^{13}C - ^1H pairs without neighboring protons may therefore show up at a much lower intensity. In such cases it may help to increase d1 from the default 60ms.
- The adiabatic pulses and rapid recycle time make the ASAPHMQC experiment a good choice for obtaining carbon information in automation. This experiment is also a good way to rapidly obtain “survey” carbon information for a subsequent band-selective experiment (see Chapter 7).

References:

E. Kupce, R. Freeman, J. Magn. Reson. Ser. A 117 (1995) 246-256.
(Adiabatic Pulses)

E. Kupce, R. Freeman, Magn. Reson. Chem. 45 (2007) 2-4. (ASAPHMQC)

4 Heteronuclear 2D 1-bond - J1(CH)corr Tips, tricks, and next steps



5 Heteronuclear 2D multiple-bond - Jn(CH)corr

Jn(CH)corr Tab	176
gHMBCAD	178
gHMBC	182
gH2BCAD	186
gH2BC	190
CIGAR	194
CIGARAD	198
HMBC	202
gHMBCmeAD	206
gHMBCRELAY	212



Jn(CH)corr Tab

This tab of the experiment selector contains 2D experiments showing long-range couplings from protons to carbon nuclei. The most commonly used experiment type, the HMBC, is available both with and without adiabatic 180° carbon pulses, and also with and without gradient coherence selection. The gradient enhanced version of the experiment has better artifact suppression at the expense of a loss of sensitivity (factor of ~ 1.4). The adiabatic version, gHMBCAD is very highly recommended, as it provides more uniform inversion profiles for a wide ^{13}C spectral width, and at the same time compensates for any ^{13}C pwx imperfections in the 180° pulses. There is a multiplicity- edited version of this experiment, gHMBCmeAD, and an experiment that provides similar information to differentiate between 2-bond and >2-bond couplings, the gHMBCRELAY. The H2BC experiment (adiabatic and non-adiabatic) is used to show specifically 2-bond proton-carbon correlations involving non-quaternary carbons. This experiment is, in principle, an HMQC-COSY equivalent. Finally, there are the adiabatic and non-adiabatic CIGAR experiments. While the HMBC experiments are typically optimized for a single Jn(XH) coupling constant, the CIGAR experiments attempt to optimize a range for this coupling constant. This experiment is particularly effective for ^{15}N , where the Jn(NH) coupling constants can vary widely.

Long-range proton-carbon correlations are often used in structure elucidation to provide key connectivity data between separated spin systems and to quaternary carbons. The HMBC type experiments are generally more sensitive than 1D CARBON spectra for detecting quaternary carbons (with the exception of carbons which are 3 or 4 bonds away from any proton). The sensitivity of these experiments does vary widely from correlation to correlation. When the HMBC type experiments are used with less concentrated samples, while it may not show all correlations, even a partial long range correlation data set is highly valuable for structure elucidation.

Most of these experiments (except gHMBCRELAY, gH2BC and gH2BCAD) rely on ^1H - ^{13}C correlations via long-range coupling constants. In general 3-bond coupling constants (~ 8 Hz) are larger than 2-bond coupling constants (~ 2 -3 Hz) and typically tend to give stronger crosspeaks when the experiment parameters are optimized for 8 Hz. However, care must be exercised in interpreting these crosspeaks from their intensity as arising

from 2 or 3 bond correlations, as they can only be definitively identified as crosspeaks due to smaller coupling constants (and may be 2, 3, or 4 bonds away). The 2-bond correlation experiments gH2BC and gH2BCAD, although less sensitive than the HMBC, are used to distinguish between 2- and 3-bond correlations.

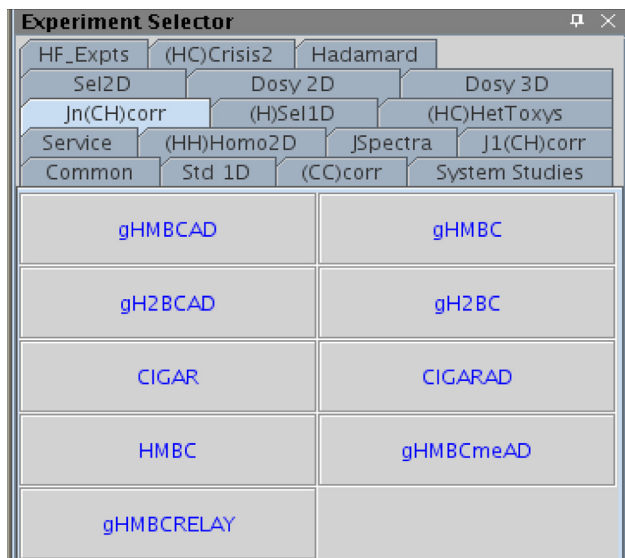

gHMBCAD

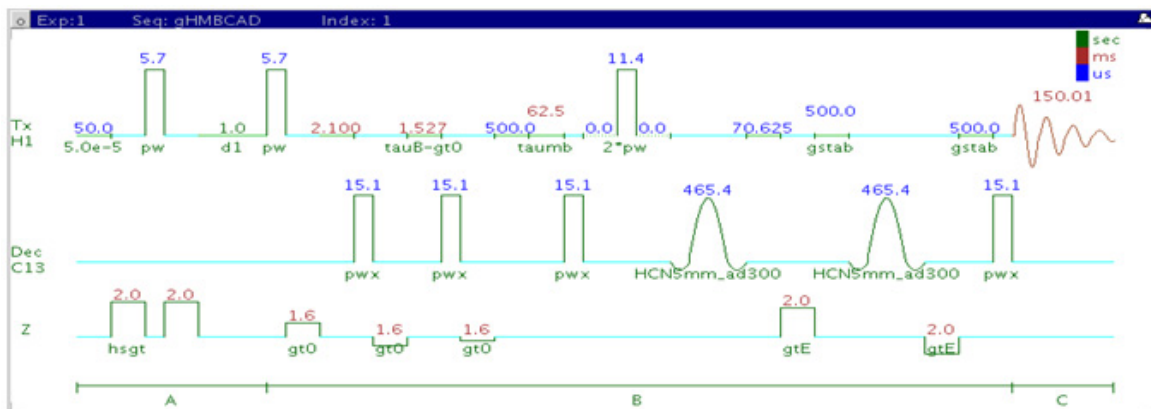

General description and usage

Description:

Two dimensional heteronuclear multiple-bond J-correlation spectroscopy with adiabatic 180° X-nuclei pulses and gradient coherence selection.

Usage:

The gHMBCAD experiment is used to acquire a 2-dimensional spectrum to correlate protons with carbons, usually over 2-3 bonds with the 3-bond correlations typically being stronger. The experiment is highly useful for structure elucidation as the longer range correlations allow connectivities between isolated proton spin systems to be identified. The gHMBCAD experiment is also one of the most sensitive ways to obtain information about quaternary carbon chemical shifts and connectivities. All parameters are set from the “Acquire” tab/”Defaults” panel unless otherwise specified.

Key parameters

Parameter	Description
Spectral Width (sw)	Set from previously acquired PROTON*
Acquisition time (at)	Set from "Pulse Sequence" panel, controls the resolution in F2, default 0.15s
F1 Nucleus (dn)	Pull- down menu to set F1 nucleus to ^{13}C , ^{15}N , or other*
C13 Spectral Width (ppm)	Type in desired chemical shift range for F1 dimension
Scans per t1 increment (nt)	Select typical choices from pull down menu*
t1 Increments (ni)	Select typical choices from pull down menu*- controls the resolution in F1 (minimum ~64)
Multiple-Bond JnXH (jnxh)	Pull-down menu to set value for the average $^n\text{J}_{\text{X,H}}$ - 8 Hz works well for most molecules
One-Bond suppression	Set from "Pulse Sequence" panel- turn on/off suppression of one-bond correlations- default is on
Steady State (ss)	Set from "Pulse Sequence" panel, turn on/off gradient cleanup between scans

NOTE

You can type specific values for these parameters manually in the appropriate boxes on the "Acquisition" or "Pulse Sequence" panels.

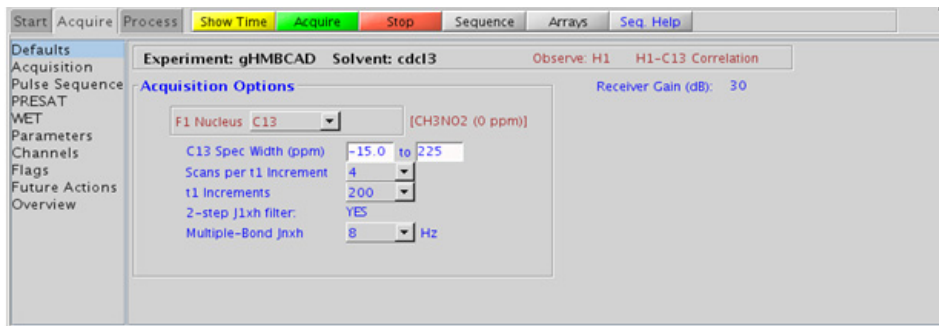

Processing

Automated processing is turned on by default, and the parameters are set to reasonable values, such that the resulting data after the acquisition usually requires no further adjustment. The “Process” tab/“Basic” panel contains many of the commonly modified processing parameters, such as a pull-down menu to change the FT data size (2k x 1k is the default), as well as a check box to turn on/off linear prediction and a pull-down to control the extent of linear prediction (default is 4*ni). Menus to quickly change the weighting functions in F2/F1 are also present (defaults are gaussian in F1 and sqsinebell in F2). More processing details are found under some of the other “Process” panels, such as the “Default”, “Weighting”, and “More 2D” panels. It is important to note that this experiment employs mix-mode processing, with the F2 dimension absolute value and F1 phase sensitive mode. This arrangement allows for the best balance of resolution and sensitivity.

Tips, tricks, and next steps

- Spectral width (sw) setting transfers from a PROTON if the gHMBCAD is set up from this experiment. Receiver gain (gain) is usually set to a high value (≥ 30), unless the sample is extremely concentrated or ^{13}C -labelled.
- The default number of steady state scans (ss) that are acquired before data acquisition to establish sample equilibrium is 32, which works for most samples. This value is changed on the “Acquisition” panel of the “Acquire” tab if necessary.
- The default parameters use a Grad-90-Grad steady state between scans, which helps cleanup un-relaxed magnetization. This can result in much cleaner spectra, especially when using shorter acquisition times (at) and relaxation delays (d1) (defaults are 0.15s and 1s, respectively).
- In general, the HMBC-type experiments have the best sensitivity of the Jn(CH)corr experiments- the other experiments provide specialized data for specific information types.

- The `jnxh` sets the optimal value of the proton-carbon coupling constant for detection. Using smaller values may increase the chances of seeing longer-range correlations, but at the expense of correlations with larger coupling constants, and, more importantly, at the expense of sensitivity loss. The CIGARAD experiment is better suited on a reasonably concentrated sample for detecting longer range correlations from a range of coupling constants, but at the expense of sensitivity.
- The experiment features a 2-step low-pass filter that can eliminate undesired crosspeaks from one-bond couplings. Select two coupling constants on the “Pulse Sequence” panel around which one-bond couplings are eliminated (default values are 165 and 130 Hz). These filters are rather narrow-band, however, and if the spread of coupling constants is such that some couplings lie considerably outside these values (for example 115 or 145 Hz), its signals may still be visible in the spectrum. As HMBC-type spectra are recorded without ^{13}C decoupling, such signals can usually still be discerned from long-range crosspeaks by their one-bond splitting.
- The gHMBCAD uses adiabatic 180° carbon pulses and invariably gives better results than the gHMBC.

References:

- A. Bax, M. F. Summers, *J. Am. Chem. Soc.* 108 (1986) 2093-2094. (HMBC)
- R. E. Hurd, *J. Magn. Reson.* 87 (1990) 422-428. (Gradient based Coherence Selection)
- C. E. Hadden, *Magn. Reson. Chem.* 43 (2005) 330-333. (Adiabatic Pulses)

5 Heteronuclear 2D multiple-bond - Jn(CH)corr gHMBC

gHMBC

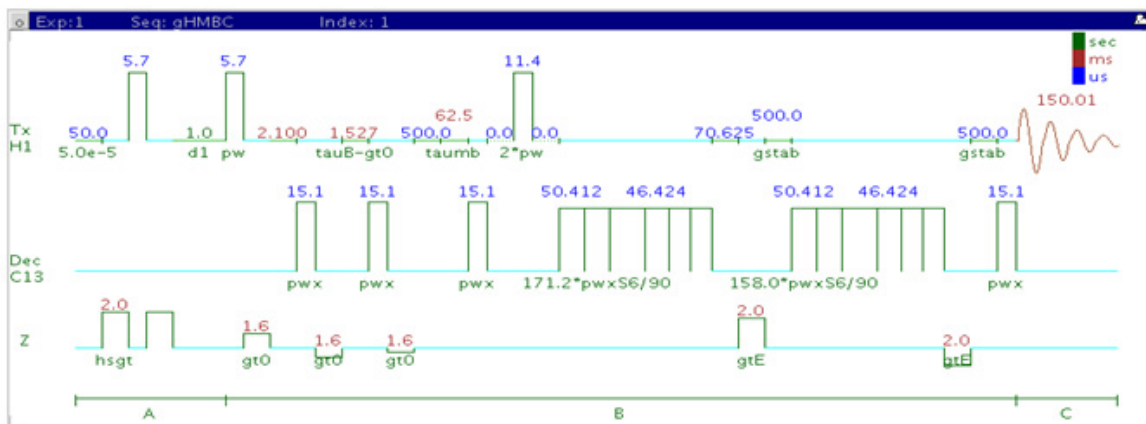

General description and usage

Description:

Two dimensional heteronuclear multiple-bond J-correlation spectroscopy with gradient coherence selection.

Usage:

The gHMBC experiment is used to acquire a 2-dimensional spectrum to correlate protons with carbons, usually over 2-3 bonds with the 3-bond correlations typically being stronger. The experiment is highly useful for structure elucidation as the longer range correlations allow connectivities between isolated proton spin systems to be identified. The gHMBC experiment is also one of the most sensitive ways to obtain information about quaternary carbon chemical shifts and connectivities. All parameters are set from the “Acquire” tab/”Defaults” panel unless otherwise specified.

Key parameters

Parameter	Description
Spectral Width (sw)	Set from previously acquired PROTON*
Acquisition time (at)	Set from "Pulse Sequence" panel, controls the resolution in F2, default 0.15s
F1 Nucleus (dn)	Pull- down menu to set F1 nucleus to ^{13}C , ^{15}N , or other*
C13 Spectral Width (ppm)	Type in desired chemical shift range for F1 dimension
Scans per t1 increment (nt)	Select typical choices from pull down menu*
t1 Increments (ni)	Select typical choices from pull down menu*- controls the resolution in F1 (minimum ~64)
Multiple-Bond JnXH (jnxh)	Pull-down menu to set value for the average $^n\text{J}_{\text{X,H}}$ - 8 Hz works well for most molecules
One-Bond suppression	Set from "Pulse Sequence" panel- turn on/off suppression of one-bond correlations- default is on
Steady State (ss)	Set from "Pulse Sequence" panel, turn on/off gradient cleanup between scans

NOTE

You can type specific values for these parameters manually in the appropriate boxes on the "Acquisition" or "Pulse Sequence" panels.

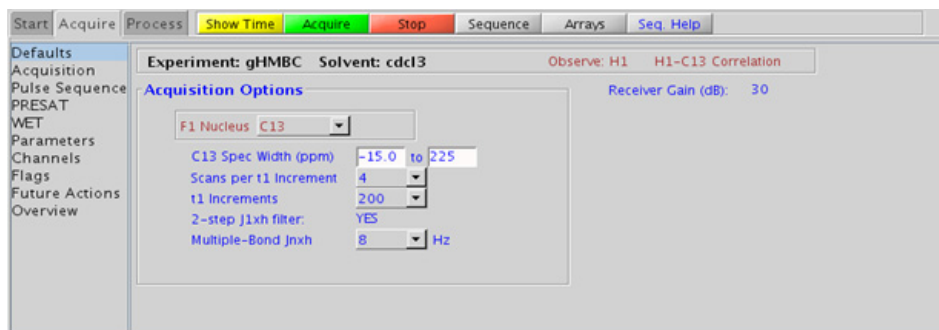

Processing

Automated processing is turned on by default, and the parameters are set to reasonable values, such that the resulting data after the acquisition usually requires no further adjustment. The “Process” tab/“Basic” panel contains many of the commonly modified processing parameters, such as a pull-down menu to change the FT data size (2k x 1k is the default), as well as a check box to turn on/off linear prediction and a pull-down to control the extent of linear prediction (default is 4*ni). Menus to quickly change the weighting functions in F2/F1 are also present (defaults are gaussian in F1 and sqsinebell in F2). More processing details are found under some of the other “Process” panels, such as the “Default”, “Weighting”, and “More 2D” panels. It is important to note that this experiment employs mix-mode processing, with the F2 dimension absolute value and F1 phase sensitive mode. This arrangement allows for the best balance of resolution and sensitivity.

Tips, tricks, and next steps

- Spectral width (sw) setting transfers from a PROTON if the gHMBC is set up from this experiment. Receiver gain (gain) is usually set to a high value (≥ 30), unless the sample is extremely concentrated or ^{13}C -labelled.
- The default number of steady state scans (ss) that are acquired before data acquisition to establish sample equilibrium is 32, which works for most samples. This value is changed on the “Acquisition” panel of the “Acquire” tab if necessary.
- The default parameters use a Grad-90-Grad steady state between scans, which helps cleanup un-relaxed magnetization. This can result in much cleaner spectra, especially when using shorter acquisition times (at) and relaxation delays (d1) (defaults are 0.15s and 1s, respectively).
- The HMBC experiment has a sensitivity advantage (factor of ~ 1.4) over the gHMBC, but due to t1 noise from strong signals such as t-butyl may produce potentially less clean spectra than its gradient counterpart.
- In general, the HMBC-type experiments have the best sensitivity of the Jn(CH)corr experiments- the other experiments provide specialized data for specific information types.

- The `jnxh` sets the optimal value of the proton-carbon coupling constant for detection. Using smaller values may increase the chances of seeing longer-range correlations, but at the expense of correlations with larger coupling constants, and, more importantly, at the expense of sensitivity loss. The CIGAR experiment is better suited on a reasonably concentrated sample for detecting longer-range correlations from a range of coupling constants, but at the expense of sensitivity.
- The experiment features a 2-step low-pass filter that can eliminate undesired crosspeaks from one bond couplings. Select two coupling constants on the “Pulse Sequence” panel around which one-bond couplings are eliminated (default values are 165 and 130 Hz). These filters are rather narrow-band, however, and if the spread of coupling constants is such that some couplings lie considerably outside these values (for example 115 or 145 Hz), its signals may still be visible in the spectrum. As HMBC-type spectra are recorded without ^{13}C decoupling, such signals can usually still be discerned from long-range crosspeaks by their one-bond splitting.
- The gHMBC uses the Shaka6 (S6) pulse to achieve broadband inversion. Parameters relating to this pulse is found on the “Pulse Sequence” tab.
- The gHMBCAD uses adiabatic 180° carbon pulses and invariably gives better results than the gHMBC.

References:

- A. Bax, M. F. Summers, *J. Am. Chem. Soc.* 108 (1986) 2093-2094. (HMBC)
- R. E. Hurd, *J. Magn. Reson.* 87 (1990) 422-428. (Gradient based Coherence Selection)

5 Heteronuclear 2D multiple-bond - Jn(CH)corr gH2BCAD

gH2BCAD

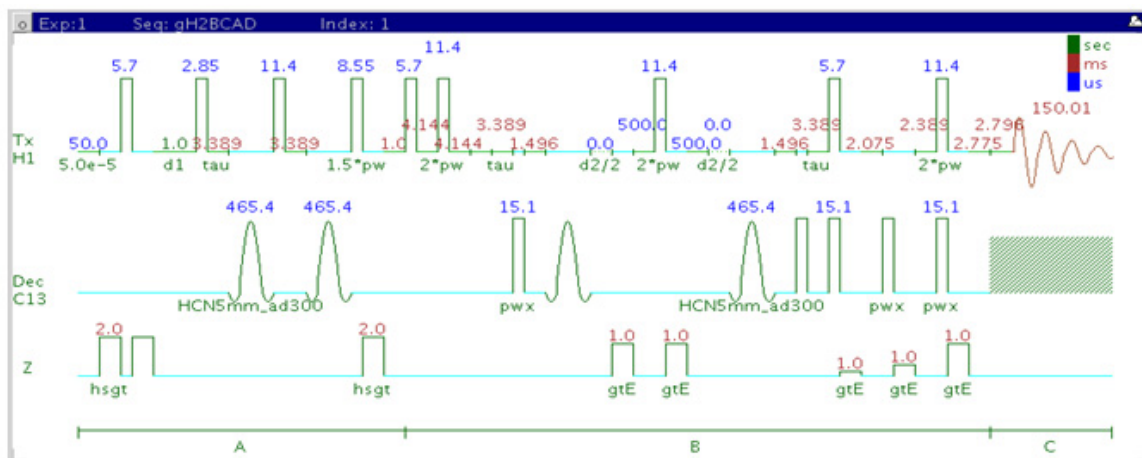

General description and usage

Description:

Two dimensional heteronuclear 2-bond J-correlation spectroscopy with adiabatic 180° X-nuclei pulses and gradient coherence selection.

Usage:

The gH2BCAD experiment is used to acquire a 2-dimensional spectrum to correlate protons with carbons through ^1H - ^1H vicinal and ^1H - ^{13}C one bond coupling connectivity. Although less sensitive than the gHMBCAD, this experiment is useful as supplemental information to distinguish between 2- and 3-bond correlations. Note that the experiment is constant time in F1, so the constant time delay (BigT) determines the maximum number of increments (ni). All parameters are set from the “Acquire” tab/”Defaults” panel unless otherwise specified.

Key parameters

Parameters	Description
Spectral Width (sw)	Set from previously acquired PROTON*
Acquisition time (at)	Set from "Pulse Sequence" panel, controls the resolution in F2, default 0.15s
F1 Nucleus (dn)	Pull- down menu to set F1 nucleus to ^{13}C , ^{15}N , or other*
C13 Spectral Width (ppm)	Type in desired chemical shift range for F1 dimension
Scans per t1 increment (nt)	Select typical choices from pull down menu*
Constant Time (BigT)	Type in value for constant time delay- 22ms (default) works for most samples
t1 Increments (ni)	Type in value- controls the resolution in F1 (note maximum allowed from the constant timedelay (BigT))
Steady State (ss)	Set from "Pulse Sequence" panel, turn on/off gradient cleanup between scans
C12-H1 suppression	Set from "Pulse Sequence" panel- turn on/off TANGO-gradient suppression- default is on

NOTE

You can type specific values for these parameters manually in the appropriate boxes on the "Acquisition" or "Pulse Sequence" panels.

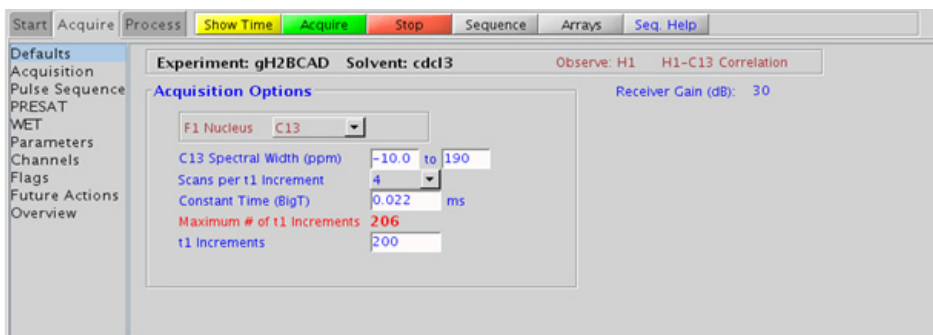

Processing

Automated processing is turned on by default, and the parameters are set to reasonable values, such that the resulting data after the acquisition usually requires no further adjustment. The “Process” tab/“Basic” panel contains many of the commonly modified processing parameters, such as a pull-down menu to change the FT data size (256k x 256k is the default), as well as a check box to turn on/off linear prediction and a pull-down to control the extent of linear prediction (default is 4*ni). Menus to quickly change the weighting functions in F2/F1 are also available (defaults are gaussian in both F1 and F2 dimensions). More processing details are found under some of the other “Process” panels, such as the “Default”, “Weighting”, and “More 2D” panels.

Tips, tricks, and next steps

- Spectral width (sw) setting transfers from a PROTON if the gH2BCAD is set up from this experiment. Receiver gain (gain) is usually set to a high value (≥ 30), unless the sample is extremely concentrated or ^{13}C -labelled.
- The default number of steady state scans (ss) that are acquired before data acquisition to establish sample equilibrium is 32, which works for most samples. This value is changed on the “Acquisition” panel of the “Acquire” tab if necessary.
- The default parameters use a Grad-90-Grad steady state between scans, which helps cleanup un-relaxed magnetization. This can result in much cleaner spectra, especially when using shorter acquisition times (at) and relaxation delays (d1) (defaults are 0.15s and 1s, respectively).
- The gH2BCAD is in principle a gHMQC-COSY type experiment. By this very nature, it can only show 2-bond correlations to protonated carbons but not for quaternary carbons. A 22ms bigT delay is an optimal value for COSY magnetization transfer.
- The gH2BCAD experiment is specialized to show only 2-bond correlations, but it is less sensitive than the gHMBCAD experiment. As such, the gH2BCAD is best used as supplemental information to the gHMBCAD data to distinguish between 2- and 3-bond correlations.

- The gH2BCAD uses adiabatic 180° carbon pulses and invariably gives better results than the gH2BC.

References:

N. T. Nyberg, J. O. Duus, O. W. Sorensen, J. Am. Chem. Soc. 127 (2007) 6154-6155. (H2BC)

R. E. Hurd, J. Magn. Reson. 87 (1990) 422-428. (Gradient based Coherence Selection)

E. Kupce, R. Freeman, J. Magn. Reson. Ser. A 117 (1995) 246-256. (Adiabatic Pulses)

gH2BC

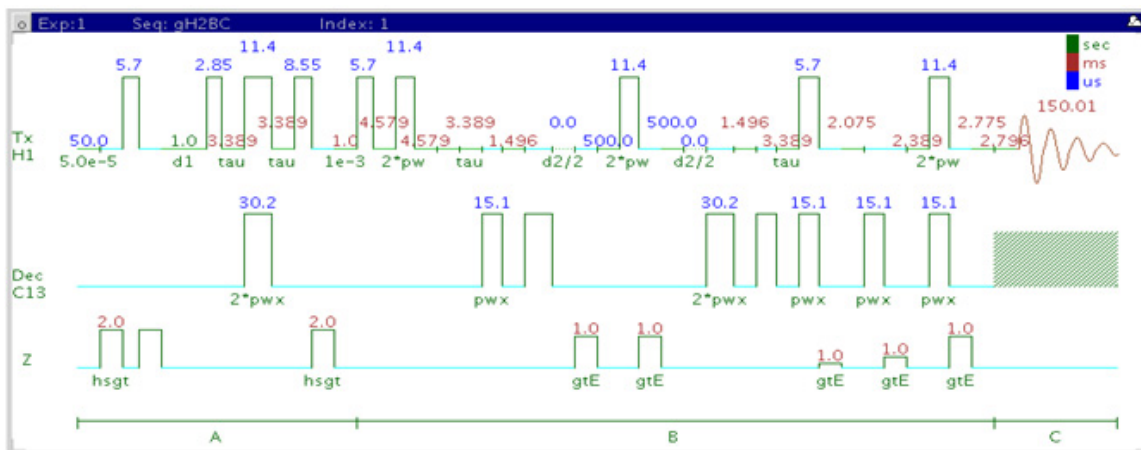

General description and usage

Description:

Two dimensional heteronuclear 2-bond J-correlation spectroscopy with gradient coherence selection.

Usage:

The gH2BC experiment is used to acquire a 2dimensional spectrum to correlate protons with carbons through ^1H - ^1H vicinal and ^1H - ^{13}C one-bond coupling connectivity. Although less sensitive than the gHMBC, this experiment is useful as supplemental information to distinguish between 2- and 3-bond correlations. Note that the experiment is constant time in F1, so the constant time delay (BigT) determines the maximum number of increments (ni). All parameters are set from the “Acquire” tab/”Defaults” panel unless otherwise specified.

Key parameters

Parameter	Description
Spectral Width (sw)	Set from previously acquired PROTON*
Acquisition time (at)	Set from "Pulse Sequence" panel, controls the resolution in F2, default 0.15s
F1 Nucleus (dn)	Pull- down menu to set F1 nucleus to ^{13}C , ^{15}N , or other*
C13 Spectral Width (ppm)	Type in desired chemical shift range for F1 dimension
Scans per t1 increment (nt)	Select typical choices from pull down menu*
Constant Time (BigT)	Type in value for constant time delay- 22ms (default) works for most samples
t1 Increments (ni)	Type in value- controls the resolution in F1 (note maximum allowed from the constant timedelay (BigT))
Steady State (ss)	Set from "Pulse Sequence" panel, turn on/off gradient cleanup between scans
C12-H1 suppression	Set from "Pulse Sequence" panel- turn on/off TANGO-gradient suppression- default is on

NOTE

You can type specific values for these parameters manually in the appropriate boxes on the "Acquisition" or "Pulse Sequence" panels.

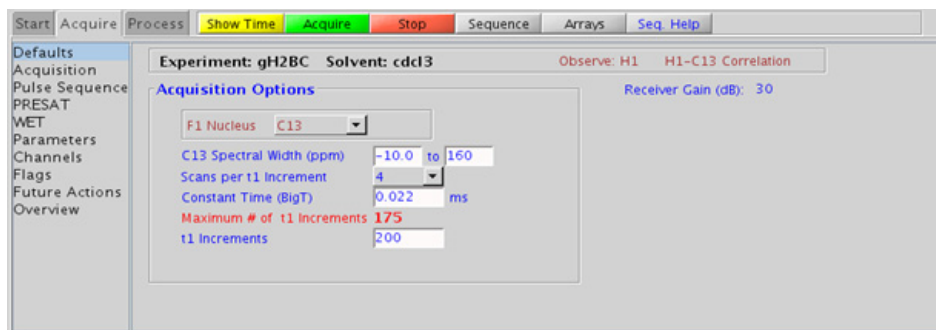

Processing

Automated processing is turned on by default, and the parameters are set to reasonable values, such that the resulting data after the acquisition usually requires no further adjustment. The “Process” tab/“Basic” panel contains many of the commonly modified processing parameters, such as a pull-down menu to change the FT data size (256k x 256k is the default), as well as a check box to turn on/off linear prediction and a pull-down to control the extent of linear prediction (default is 4*ni). Menus to quickly change the weighting functions in F2/F1 are also available (defaults are gaussian in both F1 and F2 dimensions). More processing details are found under some of the other “Process” panels, such as the “Default”, “Weighting”, and “More 2D” panels.

Tips, tricks, and next steps

- Spectral width (sw) setting transfers from a PROTON if the gH2BC is set up from this experiment. Receiver gain (gain) is usually set to a high value (≥ 30), unless the sample is extremely concentrated or ^{13}C -labelled.
- The default number of steady state scans (ss) that are acquired before data acquisition to establish sample equilibrium is 32, which works for most samples. This value is changed on the “Acquisition” panel of the “Acquire” tab if necessary.
- The default parameters use a Grad-90-Grad steady state between scans, which helps cleanup un-relaxed magnetization. This can result in much cleaner spectra, especially when using shorter acquisition times (at) and relaxation delays (d1) (defaults are 0.15s and 1s, respectively).
- The gH2BC is in principle a gHMQC-COSY type experiment. By this very nature, it can only show 2-bond correlations to protonated carbons but not for quaternary carbons. A 22ms bigT delay is an optimal value for COSY magnetization transfer.
- The gH2BC experiment is specialized to show only 2-bond correlations, however it is less sensitive than the gHMBC experiment. As such, the H2BC is best used as supplemental information to the gHMBC data to distinguish between 2- and 3-bond correlations.

References:

N. T. Nyberg, J. O. Duus, O. W. Sorensen, J. Am. Chem. Soc. 127 (2007) 6154-6155. (H2BC)

R. E. Hurd, J. Magn. Reson. 87 (1990) 422-428. (Gradient based Coherence Selection)

CIGAR

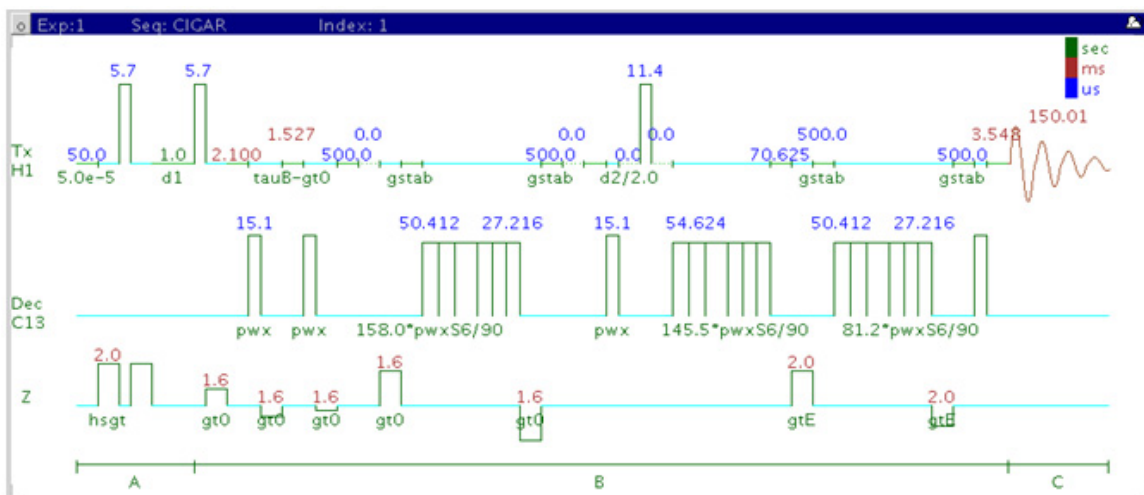

General description and usage

Description:

Two dimensional heteronuclear multiple-bond J-correlation spectroscopy.

Usage:

The CIGAR experiment is used to acquire a 2-dimensional spectrum to correlate protons to carbons over multiple bonds. Although less sensitive than its gHMBC counterpart, this experiment is useful when there is a need to see longer range correlations (>3 bonds and/or with small coupling constants), or when there is a large range of ${}^nJ_{X,H}$ coupling constants, such as with proton-nitrogen. All parameters are set from the "Acquire" tab/"Defaults" panel unless otherwise specified.

Key parameters

Parameter	Description
Spectral Width (sw)	Set from previously acquired PROTON*
Acquisition time (at)	Set from "Pulse Sequence" panel, controls the resolution in F2, default 0.15s
F1 Nucleus (dn)	Pull- down menu to set F1 nucleus to ^{13}C , ^{15}N , or other*
C13 Spectral Width (ppm)	Type in desired chemical shift range for F1 dimension
Scans per t1 increment (nt)	Select typical choices from pull down menu*
t1 Increments (ni)	Select typical choices from pull down menu*- controls the resolution in F1 (minimum ~64)
Multiple-Bond jnxh (max/min)	Set values for the maximum/minimum $^n\text{J}_{\text{X,H}}$
One-Bond suppression	Set from "Pulse Sequence" panel- turn on/off suppression of one-bond correlations-default is on
Steady State (ss)	Set from "Pulse Sequence" panel, turn on/off gradient cleanup between scans

NOTE

You can type specific values for these parameters manually in the appropriate boxes on the "Acquisition" or "Pulse Sequence" panels.

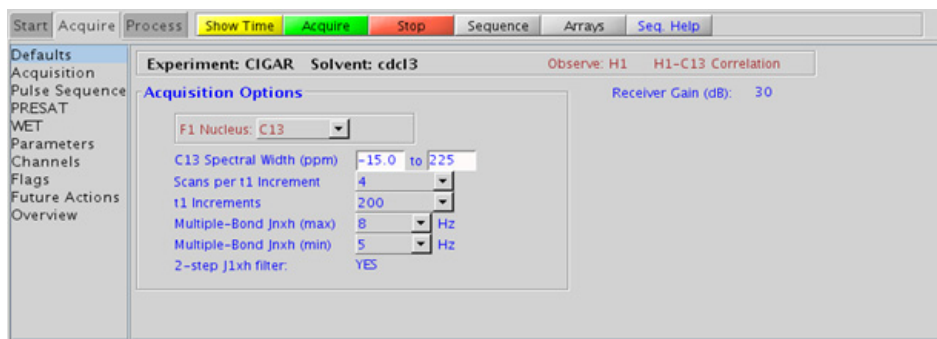

Processing

Automated processing is turned on by default, and the parameters are set to reasonable values, such that the resulting data after the acquisition usually requires no further adjustment. The “Process” tab/“Basic” panel contains many of the commonly modified processing parameters, such as a pull-down menu to change the FT data size (2k x 1k is the default), as well as a check box to turn on/off linear prediction and a pull-down to control the extent of linear prediction (default is 4*ni). Menus to quickly change the weighting functions in F2/F1 are also present (defaults are gaussian in F1 and sqsinebell in F2). More processing details are found under some of the other “Process” panels, such as the “Default”, “Weighting”, and “More 2D” panels. It is important to note that this experiment employs mix-mode processing, with the F2 dimension absolute value and F1 phase sensitive mode. This arrangement allows for the best balance of resolution and sensitivity.

Tips, tricks, and next steps

- Spectral width (sw) setting transfers from a PROTON if the CIGAR is set up from this experiment. Receiver gain (gain) is usually set to a high value (≥ 30), unless the sample is extremely concentrated or ^{13}C -labelled.
- The default number of steady state scans (ss) that are acquired before data acquisition to establish sample equilibrium is 32, which works for most samples. This value is changed on the “Acquisition” panel of the “Acquire” tab if necessary.
- The default parameters use a Grad-90-Grad steady state between scans, which helps cleanup un-relaxed magnetization. This can result in much cleaner spectra, especially when using shorter acquisition times (at) and relaxation delays (d1) (defaults are 0.15s and 1s, respectively).
- The parameter jscaleU and jscaleD (accessed in the “Pulse Sequence” panel) are typically set to 0 for best sensitivity, which are the default values. However, you can set these to non-zero values to achieve homonuclear J dependent peak “skewing” for either improved peak identification in a crowded region (jscaleU) or to differentiate J^2 vs. J^3 crosspeaks (jscaleD).

- The CIGAR experiment is specialized to allow input of a range for ${}^nJ_{X,H}$. However, it is less sensitive than the gHMBC experiment (at least by a factor of 2). As such, the CIGAR is best used under circumstances where there is a large range for the ${}^nJ_{X,H}$ coupling constants, such as for proton-nitrogen. The CIGAR experiment may also be used when the sample is reasonably concentrated and there is a need to see longer range correlations (for example, >3-bond).
- The experiment features a 2-step low-pass filter that can eliminate undesired crosspeaks from one-bond couplings. Select two coupling constants on the “Pulse Sequence” panel around which one-bond couplings are eliminated (default values are 165 and 130 Hz). These filters are rather narrow-band, however, and if the spread of coupling constants is such that some couplings lie considerably outside these values (for example 115 or 145 Hz), its signals may still be visible in the spectrum. As HMBC-type spectra are recorded without ${}^{13}\text{C}$ decoupling, such signals can usually still be discerned from long-range crosspeaks by their one-bond splitting.
- The CIGARAD uses adiabatic 180° carbon pulses and invariably gives better results than the CIGAR.

References:

- C. E. Hadden, G. E. Martin, V. V. Krishnamurthy, *Magn. Reson. Chem.* 38 (2000) 143-147. (CIGAR)
- M. Kline, S. Cheatham, *Magn. Reson. Chem.* 41 (2003) 307-314. (${}^{15}\text{N}$ -optimized CIGAR)

CIGARAD

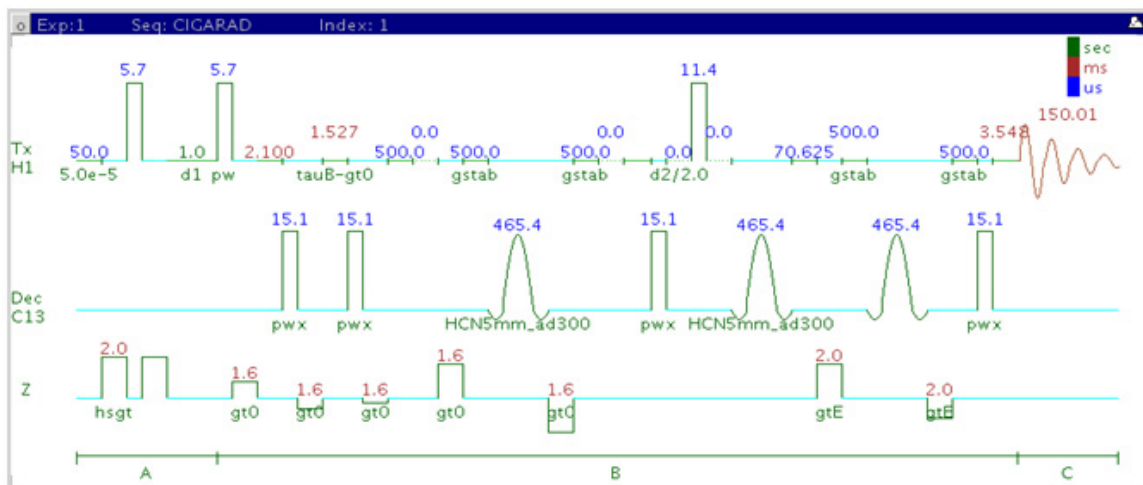

General description and usage

Description:

Two dimensional heteronuclear multiple-bond J-correlation spectroscopy with adiabatic 180° X-nuclei pulses.

Usage:

The CIGARAD experiment is used to acquire a 2-dimensional spectrum to correlate protons to carbons over multiple bonds. Although less sensitive than its gHMBC counterpart, this experiment is useful when there is a need to see longer range correlations (>3 bonds and/or with small coupling constants), or when there is a large range of $^nJ_{X,H}$ coupling constants, such as with proton-nitrogen. All parameters are set from the "Acquire" tab/"Defaults" panel unless otherwise specified.

Key parameters

Parameter	Description
Spectral Width (sw)	Set from previously acquired PROTON*
Acquisition time (at)	Set from "Pulse Sequence" panel, controls the resolution in F2, default 0.15s
F1 Nucleus (dn)	Pull- down menu to set F1 nucleus to ^{13}C , ^{15}N , or other*
C13 Spectral Width (ppm)	Type in desired chemical shift range for F1 dimension
Scans per t1 increment (nt)	Select typical choices from pull down menu*
t1 Increments (ni)	Select typical choices from pull down menu*- controls the resolution in F1 (minimum ~64)
Multiple-Bond jnxh (max/min)	Set values for the maximum/minimum $^n\text{J}_{\text{X,H}}$
One-Bond suppression	Set from "Pulse Sequence" panel- turn on/off suppression of one-bond correlations-default is on
Steady State (ss)	Set from "Pulse Sequence" panel, turn on/off gradient cleanup between scans

NOTE

You can type specific values for these parameters manually in the appropriate boxes on the "Acquisition" or "Pulse Sequence" panels.

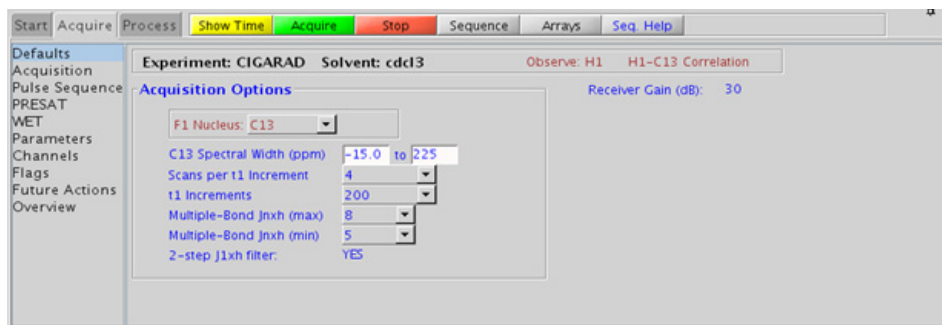

Processing

Automated processing is turned on by default, and the parameters are set to reasonable values, such that the resulting data after the acquisition usually requires no further adjustment. The “Process” tab/“Basic” panel contains many of the commonly modified processing parameters, such as a pull-down menu to change the FT data size (2k x 1k is the default), as well as a check box to turn on/off linear prediction and a pull-down to control the extent of linear prediction (default is 4*ni). Menus to quickly change the weighting functions in F2/F1 are also present (defaults are gaussian in F1 and sqsinebell in F2). More processing details are found under some of the other “Process” panels, such as the “Default”, “Weighting”, and “More 2D” panels. It is important to note that this experiment employs mix-mode processing, with the F2 dimension absolute value and F1 phase sensitive mode. This arrangement allows for the best balance of resolution and sensitivity.

Tips, tricks, and next steps

- Spectral width (sw) setting transfers from a PROTON if the CIGARAD is set up from this experiment. Receiver gain (gain) is usually set to a high value (≥ 30), unless the sample is extremely concentrated or ^{13}C -labelled.
- The default number of steady state scans (ss) that are acquired before data acquisition to establish sample equilibrium is 32, which works for most samples. This value is changed on the “Acquisition” panel of the “Acquire” tab if necessary.
- The default parameters use a Grad-90-Grad steady state between scans, which helps cleanup un-relaxed magnetization. This can result in much cleaner spectra, especially when using shorter acquisition times (at) and relaxation delays (d1) (defaults are 0.15s and 1s, respectively).
- The parameter jscaleU and jscaleD (accessed in the “Pulse Sequence” panel) are typically set to 0 for best sensitivity, which are the default values. However, you can set these to non-zero values to achieve homonuclear J dependent peak “skewing” for either improved peak identification in a crowded region (jscaleU) or to differentiate J^2 vs. J^3 crosspeaks (jscaleD).

- The CIGARAD experiment is specialized to allow input of a range for ${}^nJ_{X,H}$, however it is less sensitive than the gHMBC experiment (at least by a factor of 2). As such, the CIGARAD is best used under circumstances where there is a large range for the ${}^nJ_{X,H}$ coupling constants, such as for proton-nitrogen. The CIGARAD experiment may also be used when the sample is reasonably concentrated and there is a desire to see longer range correlations (for example, >3-bond).
- The experiment features a 2-step low-pass filter that can eliminate undesired crosspeaks from one-bond couplings. Select two coupling constants on the “Pulse Sequence” panel around which one-bond couplings are eliminated (default values are 165 and 130 Hz). These filters are rather narrow-band, however, and if the spread of coupling constants is such that some couplings lie considerably outside these values (for example 115 or 145 Hz), its signals may still be visible in the spectrum. As HMBC-type spectra are recorded without ${}^{13}\text{C}$ decoupling, such signals can usually still be discerned from long-range crosspeaks by their one-bond splitting.
- The CIGARAD uses adiabatic 180° carbon pulses and invariably gives better results than the CIGAR.

References:

- C. E. Hadden, G. E. Martin, V. V. Krishnamurthy, *Magn. Reson. Chem.* 38 (2000) 143-147. (CIGAR)
- C. E. Hadden, *Magn. Reson. Chem.* 43 (2005) 330-333. (Adiabatic Pulses)

HMBC

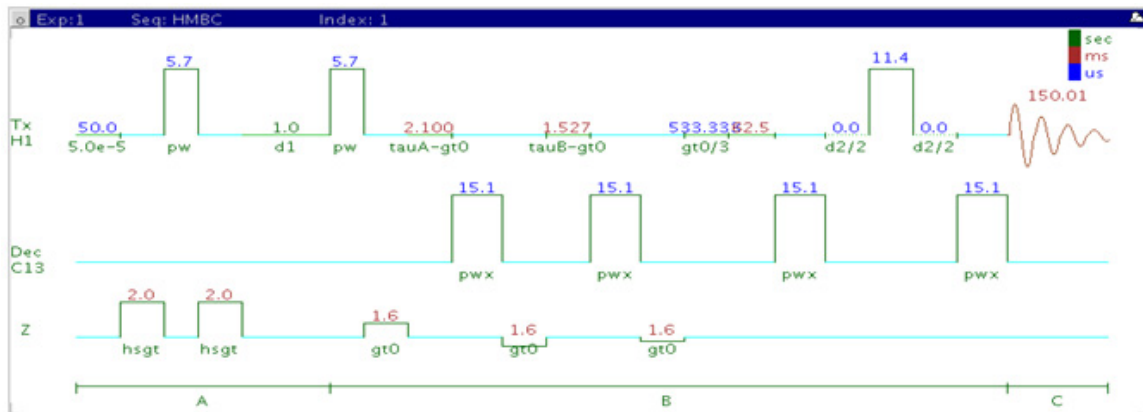

General description and usage

Description:

Two dimensional heteronuclear multiple-bond J-correlation spectroscopy with gradient coherence selection.

Usage:

The HMBC experiment is used to acquire a 2-dimensional spectrum to correlate protons with carbons, usually over 2-3 bonds with the 3-bond correlations typically being stronger. The experiment is highly useful for structure elucidation as the longer range correlations allow connectivities between isolated proton spin systems to be identified. The HMBC experiment is also one of the most sensitive ways to obtain information about quaternary carbons chemical shifts and connectivities. All parameters are set from the “Acquire” tab/”Defaults” panel unless otherwise specified.

Key parameters

Parameter	Description
Spectral Width (sw)	Set from previously acquired PROTON*
Acquisition time (at)	Set from "Pulse Sequence" panel, controls the resolution in F2, default 0.15s
F1 Nucleus (dn)	Pull- down menu to set F1 nucleus to ^{13}C , ^{15}N , or other*
C13 Spectral Width (ppm)	Type in desired chemical shift range for F1 dimension
Scans per t1 increment (nt)	Select typical choices from pull down menu*
t1 Increments (ni)	Select typical choices from pull down menu*- controls the resolution in F1 (minimum ~64)
Multiple-Bond JnXH (jnXH)	Pull-down menu to set value for the average $^n\text{J}_{\text{X,H}}$ - 8 Hz works well for most molecules
One-Bond suppression	Set from "Pulse Sequence" panel- turn on/off suppression of one-bond correlation on/off- default is on
Steady State (ss)	Set from "Pulse Sequence" panel, turn on/off gradient cleanup between scans

NOTE

You can type specific values for these parameters manually in the appropriate boxes on the "Acquisition" or "Pulse Sequence" panels.

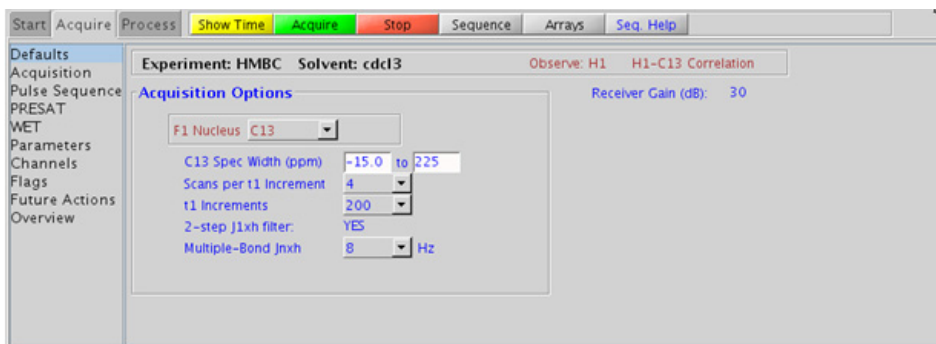

Processing

Automated processing is turned on by default, and the parameters are set to reasonable values, such that the resulting data after the acquisition usually requires no further adjustment. The “Process” tab/“Basic” panel contains many of the commonly modified processing parameters, such as a pull-down menu to change the FT data size (2k x 1k is the default), as well as a check box to turn on/off linear prediction and a pull-down to control the extent of linear prediction (default is 4*ni). Menus to quickly change the weighting functions in F2/F1 are also present (defaults are gaussian in F1 and sqsinebell in F2). More processing details are found under some of the other “Process” panels, such as the “Default”, “Weighting”, and “More 2D” panels. It is important to note that this experiment employs mix-mode processing, with the F2 dimension absolute value and F1 phase sensitive mode. This arrangement allows for the best balance of resolution and sensitivity.

Tips, tricks, and next steps

- Spectral width (sw) setting transfers from a PROTON if the HMBC is set up from this experiment. Receiver gain (gain) is usually set to a high value (≥ 30), unless the sample is extremely concentrated or ^{13}C -labelled.
- The default number of steady state scans (ss) that are acquired before data acquisition to establish sample equilibrium is 32, which works for most samples. This value is changed on the “Acquisition” panel of the “Acquire” tab if necessary.
- The default parameters use a Grad-90-Grad steady state between scans, which helps cleanup un-relaxed magnetization. This can result in much cleaner spectra, especially when using shorter acquisition times (at) and relaxation delays (d1) (defaults are 0.15s and 1s, respectively).
- The HMBC experiment has a sensitivity advantage (factor of ~ 1.4) over the gHMBC, but due to t1 noise from strong signals such as t-butyl, may produce potentially less clean spectra than its gradient counterpart. Invariably the gradient coherence selected variants (such as gHMBC or gHMBCAD) are preferred over HMBC.

- The `jnxh` sets the optimal value of the proton-carbon coupling constant for detection. Using smaller values may increase the chances of seeing longer-range correlations, but at the expense of correlations with larger coupling constants, and, more importantly, at the expense of sensitivity loss.
- The experiment features a 2-step low-pass filter that can eliminate undesired crosspeaks from one-bond couplings. Select two coupling constants on the “Pulse Sequence” panel around which one-bond couplings are eliminated (default values are 165 and 130 Hz). These filters are rather narrow-band, however, and if the spread of coupling constants is such that some couplings lie considerably outside these values (for example 115 or 145 Hz), its signals may still be visible in the spectrum. As HMBC-type spectra are recorded without ^{13}C decoupling, such signals can usually still be discerned from long-range crosspeaks by their one-bond splitting.

References:

- A. Bax, M. F. Summers, J. Am. Chem. Soc. 108 (1986) 2093-2094. (HMBC)

gHMBCmeAD

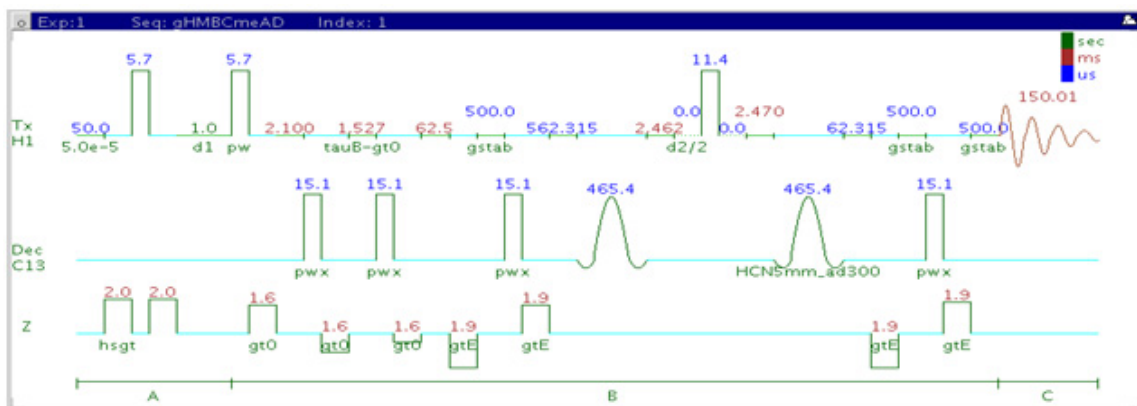

General description and usage

Description:

Two dimensional heteronuclear multiple-bond J-correlation spectroscopy with multiplicity-editing (adiabatic 180° X-nuclei pulses and gradient coherence selection).

Usage:

The gHMBCmeAD experiment is used to acquire a 2-dimensional spectrum to correlate protons to carbons, usually over 2-3 bonds with the 3-bond correlations typically being stronger. The experiment is highly useful for structure elucidation as the longer range allows connectivities between isolated proton spin systems to be confirmed. The gHMBCmeAD experiment is a multiplicity edited version of gHMBCAD. This experiment is acquired as an array of 2 spectra and needs to be processed in two different ways to generate the edited 2D spectra. For structure elucidation, carbon chemical shifts are particularly useful as they are highly sensitive

to local functional groups and can be reliably predicted with software. All parameters are set from the “Acquire” tab/”Defaults” panel unless otherwise specified.

Key parameters

Parameters	Description
Spectral Width (sw)	Set from previously acquired PROTON*
Acquisition time (at)	Set from “Pulse Sequence” panel, controls the resolution in F2, default 0.15s
F1 Nucleus (dn)	Pull- down menu to set F1 nucleus to ^{13}C , ^{15}N , or other*
C13 Spectral Width (ppm)	Type in desired chemical shift range for F1 dimension
Scans per t1 increment (nt)	Select typical choices from pull down menu*
t1 Increments (ni)	Select typical choices from pull down menu* - controls the resolution in F1 (minimum ~64)
Multiple-Bond JnXH (jnxh)	Pull-down menu to set value for the average $^nJ_{\text{X,H}}$ - 8 Hz works well for most molecules
One-Bond suppression	Set from “Pulse Sequence” panel- turn on/off suppression of one-bond correlations- default is on
Steady State (ss)	Set from “Pulse Sequence” panel, turn on/off gradient cleanup between scans

NOTE

You can type specific values for these parameters manually in the appropriate boxes on the “Acquisition” or “Pulse Sequence” panels.

5 Heteronuclear 2D multiple-bond - Jn(CH)corr Processing

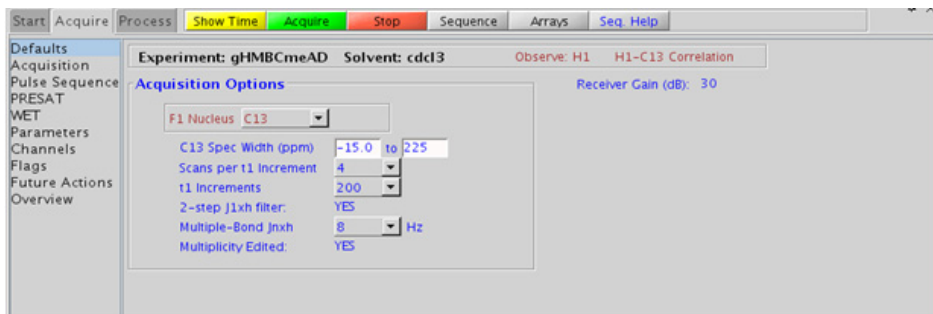

Processing

The multiplicity- editing feature requires running an array of two spectra (default setup). The “Process” tab/“Default” panel has three buttons under the “Transform” heading to select the desired subspectrum. The “Process” tab/“Basic” panel contains many of the commonly modified processing parameters, such as a pull-down menu to change the FT data size (2k x 1k is the default), as well as a check box to turn on/off linear prediction and a pull-down to control the extent of linear prediction (default is 4*ni). Menus to quickly change the weighting functions in F2/F1 are also present (defaults are gaussian in F1 and sqsinebell in F2). More processing details are found under some of the other “Process” panels, such as the “Default”, “Weighting”, and “More 2D” panels. It is important to note that this experiment employs mix-mode processing, with the F2 dimension absolute value and F1 phase sensitive mode. This arrangement allows for the best balance of resolution and sensitivity.

Tips, tricks, and next steps

- Spectral width (sw) setting transfers from a PROTON if the gHMBCmeAD is set up from this experiment. Receiver gain (gain) is usually set to a high value (≥ 30), unless the sample is extremely concentrated or ^{13}C -labelled.

- The default number of steady state scans (ss) that are acquired before data acquisition to establish sample equilibrium is 32, which works for most samples. This value is changed on the “Acquisition” panel of the “Acquire” tab if necessary.
- The default parameters use a Grad-90-Grad steady state between scans, which helps cleanup un-relaxed magnetization. This can result in much cleaner spectra, especially when using shorter acquisition times (at) and relaxation delays (d1) (defaults are 0.15s and 1s, respectively).
- The multiplicity-editing feature uses the CRISIS technique that relies on a hypothetical relationship between one-bond coupling constant and carbon chemical shift. Carbons with coupling constants that deviate significantly from this relationship result in imperfect editing.
- As the gHMBCmeAD is acquired as an array of two spectra, it takes twice as long to acquire and there is a small sensitivity loss with the multiplicity-editing.
- The experiment features a 2-step low-pass filter that can eliminate undesired crosspeaks from one-bond couplings. Select two coupling constants on the “Pulse Sequence” panel around which one-bond couplings are eliminated (default values are 165 and 130 Hz). These filters are rather narrow-band, however, and if the spread of coupling constants is such that some couplings lie considerably outside these values (for example 115 or 145 Hz), its signals may still be visible in the spectrum. As HMBC-type spectra are recorded without ¹³C decoupling, such signals can usually still be discerned from long-range crosspeaks by their one-bond splitting.

References:

- A. Bax, M. F. Summers, *J. Am. Chem. Soc.* 108 (1986) 2093-2094. (HMBC)
- R. E. Hurd, *J. Magn. Reson.* 87 (1990) 422-428. (Gradient based Coherence Selection)
- A. J. Benie, O. W. Sorensen, *Magn. Reson. Chem.* 44 (2006) 739-743. (gHMBCme)
- R. D. Boyer, R. Johnson, K. Krishnamurthy, *J. Magn. Reson.* 165 (2003) 253-259 (CRISIS)

5 Heteronuclear 2D multiple-bond - Jn(CH)corr
Tips, tricks, and next steps

gHMBCRELAY

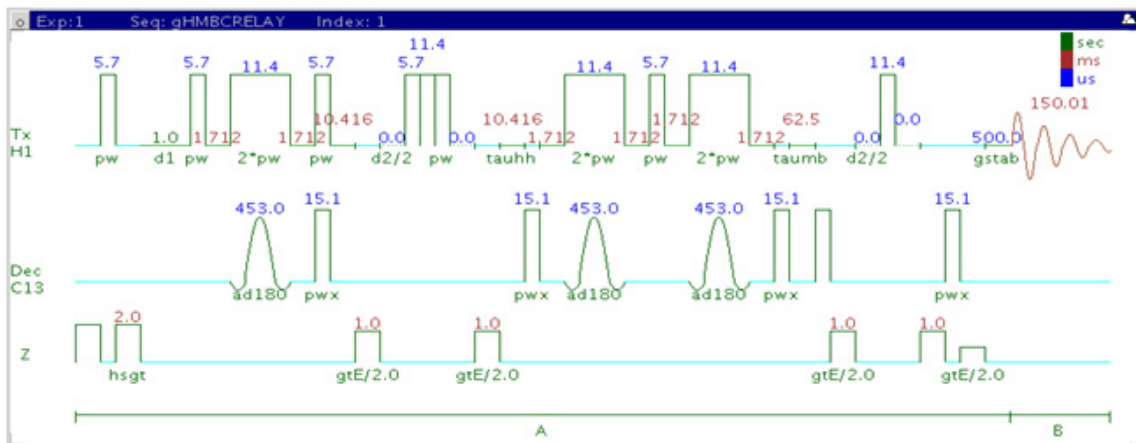

General description and usage

Description:

Two dimensional heteronuclear spectroscopy for the simultaneous detection of ${}^2J_{C,H}$ and ${}^nJ_{C,H}$ with adiabatic 180° X-nuclei pulses and gradient coherence selection.

Usage:

The gHMBCRELAY experiment is used to acquire a 2-dimensional spectrum to correlate protons to carbons over multiple bonds. Although less sensitive than the gHMBCAD, this experiment is useful as supplemental information to distinguish between 2- and 3-bond correlations, as the 2-bond correlations are created through a separate pathway and may be separated into a subspectrum. All parameters are set from the “Acquire” tab/”Defaults” panel unless otherwise specified.

Key parameters

Parameters	Description
Spectral Width (sw)	Set from previously acquired PROTON*
Acquisition time (at)	Set from "Pulse Sequence" panel, controls the resolution in F2, default 0.15s
F1 Nucleus (dn)	Pull- down menu to set F1 nucleus to ^{13}C , ^{15}N , or other*
C13 Spectral Width (ppm)	Type in desired chemical shift range for F1 dimension
Scans per t1 increment (nt)	Select typical choices from pull down menu*
t1 Increments (ni)	Select typical choices from pull down menu* - controls the resolution in F1 (minimum ~64)
Multiple-Bond Jn(xh) (jn(xh))	Pull-down menu to set value for the average $^n\text{J}_{\text{X,H}}$ - 8 Hz works well for most molecules
Homonuclear Jn(HH)	Pull-down menu to set value for the optimized $^n\text{J}_{\text{H,H}}$
Steady State (ss)	Set from "Pulse Sequence" panel, turn on/off gradient cleanup between scans

NOTE

You can type specific values for these parameters manually in the appropriate boxes on the "Acquisition" or "Pulse Sequence" panels.

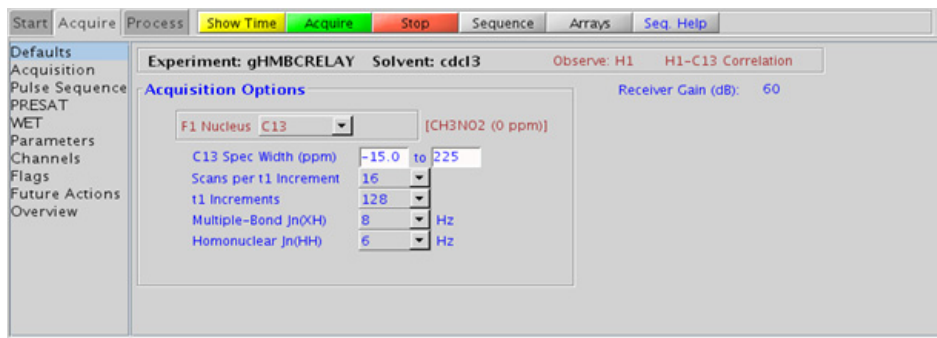

Processing

Automated processing is turned on by default, and the parameters are set to reasonable values, such that the resulting data after the acquisition usually requires no further adjustment. The “Process” tab/“Default” panel has three buttons under the “Transform” heading to select the desired subspectrum. The “Process” tab/“Basic” panel contains many of the commonly modified processing parameters, such as a pull-down menu to change the FT data size (1k x 1k is the default), as well as a check box to turn on/off linear prediction and a pull-down to control the extent of linear prediction (default is 4*ni). Menus to quickly change the weighting functions in F2/F1 are also present (defaults are squared sinebells). More processing details are found under some of the other “Process” panels, such as the “Default”, “Weighting”, and “More 2D” panels.

Tips, tricks, and next steps

- Spectral width (sw) setting transfers from a PROTON if the gHMBCRELAY is set up from this experiment. Receiver gain (gain) is usually set to a high value (≥ 30), unless the sample is extremely concentrated or ^{13}C -labelled.
- The default number of steady state scans (ss) that are acquired before data acquisition to establish sample equilibrium is 32, which works for most samples. This value is changed on the “Acquisition” panel of the “Acquire” tab if necessary.
- The default parameters use a Grad-90-Grad steady state between scans, which helps cleanup un-relaxed magnetization. This can result in much cleaner spectra, especially when using shorter acquisition times (at) and relaxation delays (d1) (defaults are 0.15s and 1s, respectively).
- The gHMBCRELAY experiment is specialized to be able to show subspectra containing only 2-bond H-C correlations, or >2-bond correlations, however it is less sensitive than the gHMBCAD experiment. As such, the gHMBCRELAY is best used only when it is important to be able to distinguish between 2- and 3-bond correlations.

References:

T. Sprang, P. Bigler, Magn. Reson. Chem. 42 (2004) 55-60. (HMBCRELAY)

R. E. Hurd, J. Magn. Reson. 87 (1990) 422-428. (Gradient based Coherence Selection)

M. R. Bendall, M. Garwood, K. Ugurbil, D. T. Pegg, Magn. Reson. Med. 4 (1987) 493-499. (Adiabatic Pulses)

5 Heteronuclear 2D multiple-bond - Jn(CH)corr
Tips, tricks, and next steps



6 Selective 1D - (H)Sel1D

(H)Sel1D Tab 218

NOESY1D 220

ROESY1D 226

TOCSY1D 232

zTOCSY1D 236

selexcit 240

stepNOESY1D 244



(H)Sel1D Tab

This tab of the experiment selector includes the set of 1D experiments performed on small, user-defined bands or resonances of the proton spectrum using selective pulses. They are useful to obtain targeted information about single resonances or small areas of a complicated proton spectrum. Included are J-coupled experiments (TOCSY1D and zTOCSY1D), through-space experiments (NOESY1D, ROESY1D), as well as a simple selective excitation experiment (selexcit). The zTOCSY1D contains a z-filter to suppress zero-quantum artifacts and, in general, give better results than TOCSY1D. The stepNOESY1D is a specialized experiment that first performs a TOCSY 1D and then a second selective NOESY1D excitation off one of the TOCSY relayed peaks.

The most direct way to set up these experiments is to first acquire a proton spectrum and then choose the appropriate selective 1D experiment. The proton spectrum can then be used as a reference to select the desired peaks/regions for the experiment. Alternatively, if the regions are known *a priori*, the selective 1D experiment can be chosen initially and the regions entered manually.

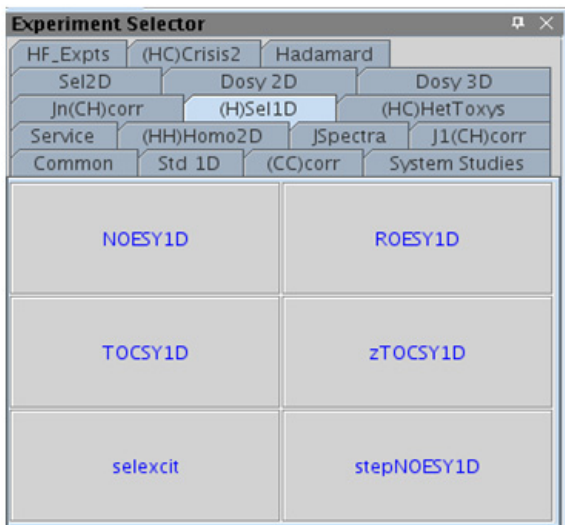

NOESY1D

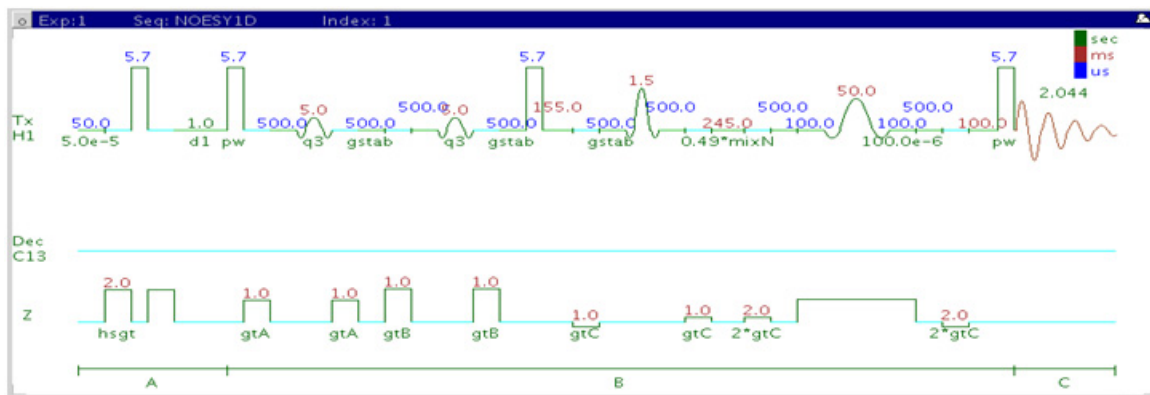

General description and usage

Description:

A pulse sequence to acquire a 1D NOESY dataset with a selective pulse to obtain NOE information from a specific frequency.

Usage:

The NOESY1D experiment is an important tool for structure elucidation as it does not require through-bond coupling connectivity for correlations, rather the NOE (Nuclear Overhauser Effect) interaction is seen between protons that are close in space (typically $<5 \text{ \AA}$). As such the NOESY1D experiment is often used to help determine stereochemistry for rigid ring systems, or to confirm attachments between proximal (but non-coupled) portions of a molecule. The selective NOESY1D experiment has an advantage over the 2D NOESY version for simplifying complicated spectra with a lot of overlapping peaks. This experiment is most easily set up from a previously acquired PROTON spectrum so the frequencies and bandwidths for NOE analysis may be chosen interactively with the cursor. All parameters are set from the "Acquire" tab/"Default" panel unless otherwise specified.

Key parameters

Parameters	Description
Solvent (solvent)	Set from "Start" tab/"Standard" panel
Spectral Width(sw)	Set from previously acquired PROTON*
Number of scans(nt)	Select typical choices from pull down menu*
NOE Mixing time (mixT)	Select from pull down menu- 500ms works well for most small molecules*
Run a mix=0 spectrum	Check box to acquire a control spectrum with a mixing time of 0ms- creates an array for mixT
No., ppm, width of selective frequencies	Select number of frequencies from the drop down menu. Enter frequency position(s) and bandwidth(s) in the entry boxes.
ZQ filter	Check box on the "Pulse Sequence" panel- zero quantum filter for artifact suppression. Strongly recommended - default is on.

NOTE

You can type specific values for these parameters manually in the appropriate boxes on the "Acquisition" or "Pulse Sequence" panels.

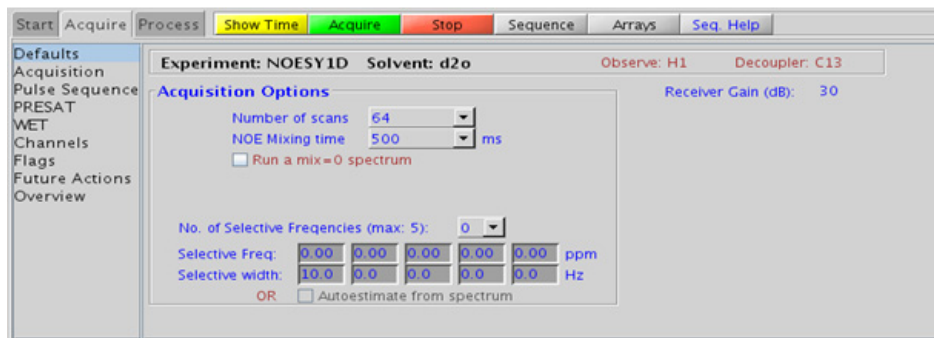

Processing

Same processing as for standard PROTON spectrum, except that manual phasing may be required as the NOE peaks may be negative for smaller molecules. A typical processing apodization choice which provides S/N enhancement (at the expense of resolution) for a 1D spectrum is line broadening, with an lb setting from ~ 0.5 -1 Hz. A suggested optimal value is line broadening equal to the peak linewidth at half-height. Other types of apodization are available under the “Process” tab on the “Weighting” panel.

Tips, tricks, and next steps

- Choosing the NOESY1D experiment from a previously acquired PROTON data set allows for interactive selection of the peaks for NOE analysis, and the “Default” panel appears differently (see below). Place the cursor(s) on or around the peak and click . Repeat for additional peaks. Results are best if isolated peaks are chosen for correlation analysis. It is advisable not to make the widths of the selected peak too narrow as this creates shaped pulses with long durations, which, in turn, can result in some sensitivity loss. The peak of interest does not necessarily have to be centered in the selection window if placing it off-center avoids interference from nearby resonances.

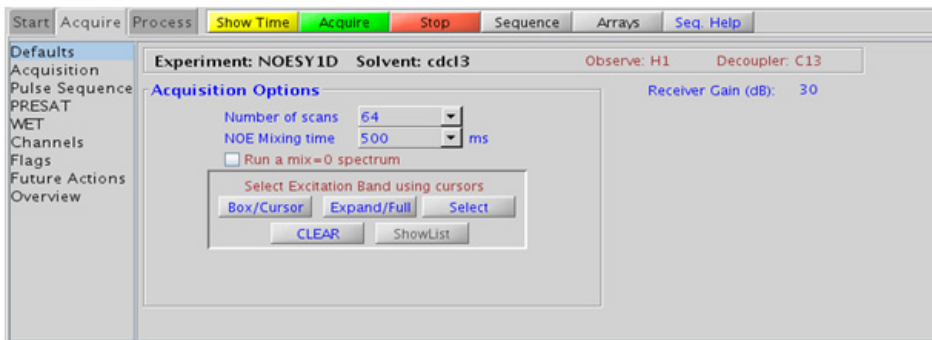

- A mixing time of 500ms is a good starting place for most small molecules. Very small molecules and/or weak NOE interactions may require longer mixing times (up to ~1s). Longer mixing times, however, increase the possibility of spin diffusion for larger molecules, a situation where the magnetization is transferred through space, and then through coupling, resulting in spurious correlations between protons. The NOE correlation is confirmed by acquiring a build-up curve, whereby the mixing time is slowly increased in 50-100ms increments until the NOE intensity ceases to increase and levels off. This is the optimal mixing time. In addition, the slope of such a build up curve can be used to determine bond distances between selected spin pairs (using methods such as PANIC).
- Molecules with multiple ring systems or a ring system combined with a long carbon chain may require different optimal mixing times for different parts of the molecule. In general, more flexible parts of the molecule require longer mixing times and more rigid, shorter.
- The NOESY1D contains zero quantum suppression element to suppress artifacts (typically antiphase in nature and interfering with spectral analysis), which is switched on by default.
- The sensitivity of the NOESY1D experiment is *not* equivalent to a PROTON, nor is an 8-scan NOESY1D equivalent to an 8-scan, 256-increment NOESY. Do not hesitate to acquire this experiment with a larger number of scans, particularly for weak/long-distance NOEs.
- When acquiring the NOESY1D with a larger number of scans, it is advisable to acquire a mixN=0 experiment with the *same number of scans* (using Run a mix=0 spectrum scans), to see peaks that appear from any potential pulse imperfections, so as not to mistake them for NOE correlations. The mixN=0 spectrum can also be used to confirm the selective excitation occurred as expected, verifying a result from the mixN0 spectrum with no observed NOE.
- Medium-sized molecules (MW ~700-1000 depending on the molecule and spectrometer frequency) can exhibit zero or very small NOEs. Consider acquiring a ROESY1D for these molecules. Alternatively one may consider (i) choosing a more viscous solvent such as d₆-DMSO or d₆-DMSO with ~10-20% D₂O (this results in slower molecular tumbling and hence generates a positive NOE enhancement like larger molecules), (ii) selecting a lower temperature (if the solvent allows it), or (iii) running the experiment on a spectrometer with higher field strength (if available).

References:

S. Macura, Y. Huang, D. Suter, R. R. Ernst, *J. Magn. Reson.* 43 (1981) 259-281. (NOESY)

K. Stott, J. Stonehouse, J. Keeler, T. L. Hwang, A. J. Shaka, *J. Am. Chem. Soc.* 117 (1995) 4199-4200. (Excitation Sculpting)

M. J. Trippleton, J. Keeler, *Angew. Chem. Int. Ed.* 42 (2003) 3938-3941. (Zero Quantum Suppression)

ROESY1D

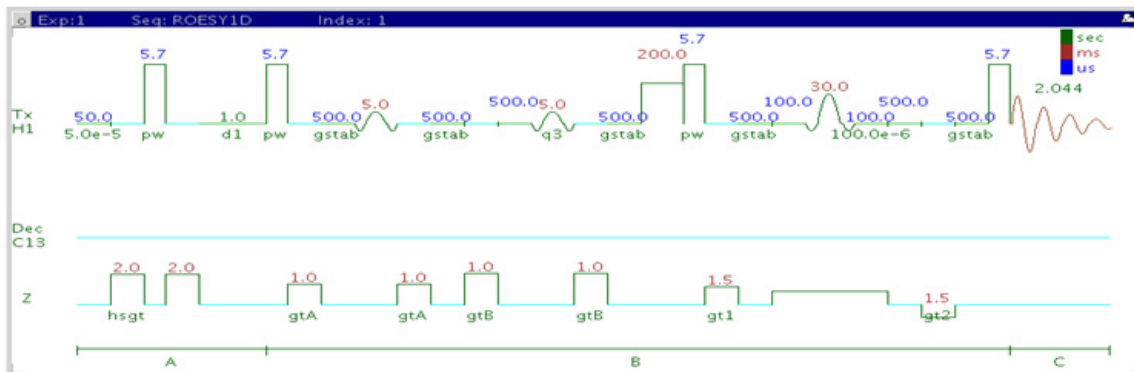

General description and usage

Description:

A pulse sequence to acquire a 1D ROESY dataset with a selective pulse to obtain ROE information from a specific frequency.

Usage:

The ROESY1D experiment is an important tool for structure elucidation as it does not require through-bond coupling connectivity for correlations, rather the ROE (rotating frame Overhauser effect) interaction is seen between protons that are close in space (typically $<4 \text{ \AA}$). As such, the ROESY1D experiment is often used to help determine stereochemistry for rigid ring systems, or to confirm attachments between proximal but non-coupled portions of a molecule. The selective ROESY1D experiment has an advantage over the 2D ROESY version for simplifying complicated spectra with a lot of overlapping peaks. This experiment is most easily set up from a previously acquired PROTON spectrum so the frequencies and bandwidths for ROE analysis may be chosen interactively with the cursor. All parameters are set from the "Acquire" tab/"Default" panel unless otherwise specified.

Key parameters

Parameter	Description
Solvent (solvent)	Set from "Start" tab/"Standard" panel
Spectral Width(sw)	Set from previously acquired PROTON*
Number of scans(nt)	Select typical choices from pull down menu*
SpinLock time	Select from pull down menu- 200ms works well for most small molecules* DO NOT EXCEED 500ms
Run a mix=0 spectrum	Check box to acquire a control spectrum with a mixing time of 0ms- creates an array
No., ppm, width of selective frequencies	Select number of frequencies from the drop down menu. Enter frequency position(s) and bandwidth(s) in the entry boxes
ZQ filter	Check box on the "Pulse Sequence" panel- zero quantum filter for artifact suppression. Strongly recommended- default is on.

NOTE

You can type specific values for these parameters manually in the appropriate boxes on the "Acquisition" or "Pulse Sequence" panels.

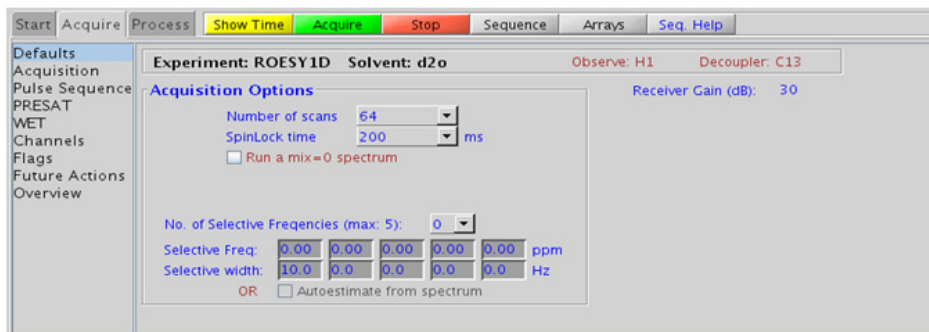

Processing

Same processing as for standard PROTON spectrum, except that manual phasing may be required, as the ROE peaks are negative. A typical processing apodization choice which provides S/N enhancement (at the expense of resolution) for a 1D spectrum is line broadening, with an lb setting from ~ 0.5 -1 Hz. A suggested optimal value is line broadening equal to the peak linewidth at half-height. Other types of apodization are available under the “Process” tab on the “Weighting” panel.

Tips, tricks, and next steps

- Choosing the ROESY1D experiment from a previously acquired PROTON data set allows for interactive selection of the peaks for ROE analysis, and the “Default” panel appears differently (see below). Place the cursor(s) on or around the peak and click . Repeat for additional peaks. Results are best if the isolated peaks are chosen for correlation analysis. It is advisable not to make the widths of the selected peak too narrow as this creates shaped pulses with long durations, which, in turn, can result in some sensitivity loss. The peak of interest does not necessarily have to be centered in the selection window if placing it off-center avoids interference from nearby resonances.

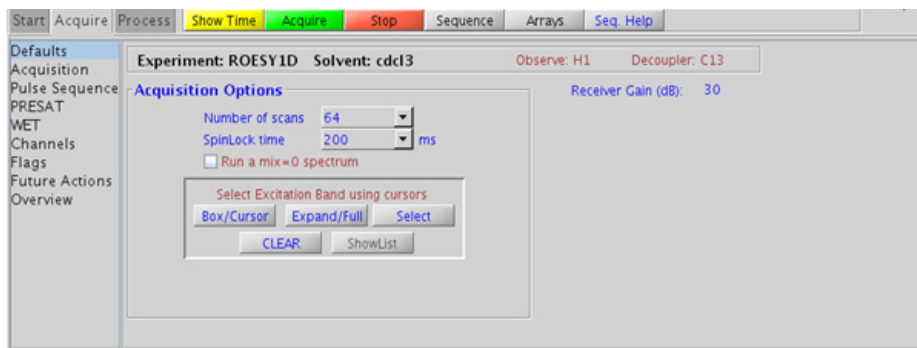

- A mixing time of 200ms is a good starting place for most small molecules. Very weak ROE interactions may require longer mixing times (up to ~500ms), but keep the mixing time shorter as longer spinlocks may result in sample heating. It is a good idea not to exceed a 500ms spinlock.
- Because the mixing time for the ROESY1D is limited, weaker correlations may not be observable. The ROESY1D is the experiment of choice over NOESY1D for medium-sized molecules (MW ~800-1000 depending on the molecule and spectrometer frequency), as they can exhibit zero or very small NOEs. One may consider running NOESY1D experiments (which can be run with longer mixing times) by (i) choosing a more viscous solvent such as d₆-DMSO or d₆-DMSO with ~10-20% D₂O (this results in slower molecular tumbling and hence generates a positive NOE enhancement like larger molecules), (ii) selecting a lower temperature (if the solvent allows it), or (iii) running the experiment on a spectrometer with higher field strength (if available).
- The ROESY1D contains zero quantum suppression element to suppress artifacts (typically antiphase in nature and interfering with spectral analysis), which is switched on by default.
- The sensitivity of the ROESY1D experiment is *not* equivalent to a PROTON, nor is an 8-scan ROESY1D equivalent to an 8-scan, 256-increment ROESY. Do not hesitate to acquire this experiment with a larger number of scans, particular for weak/long-distance ROEs.
- When acquiring the ROESY1D with a larger number of scans, it is advisable to acquire a mixR=0 experiment with the same number of scans (using Run a mix =0 spectrum scans), to see peaks that appear from any potential pulse imperfections so as not to mistake them for ROE correlations. The mixR=0 spectrum can also be used to confirm the selective excitation occurred as expected, verifying a result from the mixR0 spectrum with no observed ROE.
- Sensitivity permitting, the slope of a ROESY1D buildup curve (by an array of mixing time) can be equally used as a NOESY1D buildup curve to determine bond distances between selected spin pairs. (using methods such as PANIC)

References:

A. Bax, D. G. Davis, J. Magn. Reson. 63 (1985) 207-213. (ROESY)

6 Selective 1D - (H)Sel1D
Tips, tricks, and next steps

K. Stott, J. Stonehouse, J. Keeler, T. L. Hwang, A. J. Shaka, J. Am. Chem. Soc. 117 (1995) 4199-4200. (Excitation Sculpting)

M. J. Trippleton, J. Keeler, Angew. Chem. Int. Ed. 42 (2003) 3938-3941. (Zero Quantum Suppression)

TOCSY1D

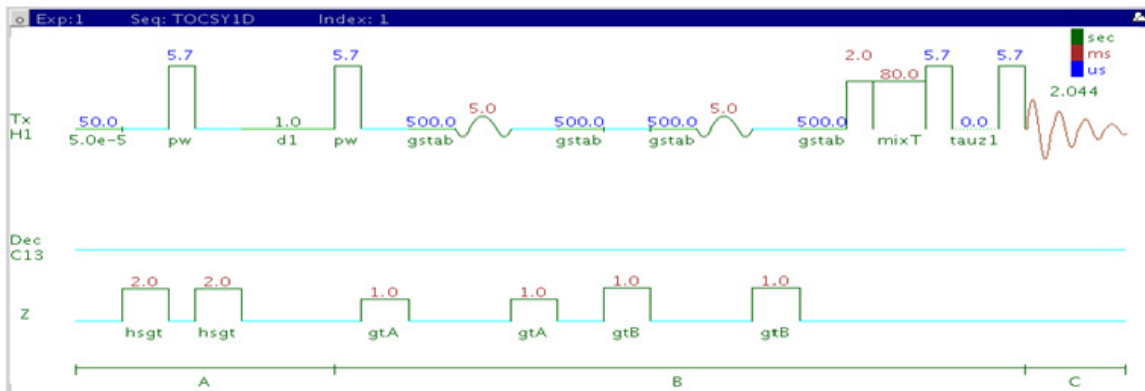

General description and usage

Description:

A pulse sequence to acquire a 1D TOCSY dataset with a selective pulse to obtain coupling information from a specific frequency.

Usage:

The TOCSY1D experiment is an important tool for structure elucidation as it can show all protons in a chosen spin system. The selective TOCSY1D experiment has an advantage over the 2D TOCSY version for simplifying complicated spectra with invariably shorter total experiment time. If one proton in a given spin system is resolved, selecting this proton for TOCSY1D analysis produces an edited 1D spectrum containing only the resonances in this spin system. This experiment is most easily set up from a previously acquired PROTON spectrum so the frequencies and bandwidths for TOCSY1D analysis may be chosen interactively with the cursor. All parameters are set from the “Acquire” tab/”Default” panel unless otherwise specified.

Key parameters

Parameter	Description
Solvent (solvent)	Set from "Start" tab/"Standard" panel
Spectral Width(sw)	Set from previously acquired PROTON*
Number of scans(nt)	Select typical choices from pull down menu*
SpinLock time	Select from pull down menu- 80ms works best for large spin systems*
Run a mix=0 spectrum	Check box to acquire a control spectrum with a mixing time of 0ms- creates an array
No., ppm, width of selective frequencies	Select number of frequencies from the drop down menu. Enter frequency positions bandwidth(s) in the entry boxes
SpinLock Pattern	Pull-down menu on the "Pulse Sequence" panel- MLEV17 or DIPSI2 works well for small molecules, clean MLEV17 is a good choice for large molecules

NOTE

You can type specific values for these parameters manually in the appropriate boxes on the "Acquisition" or "Pulse Sequence" panels.

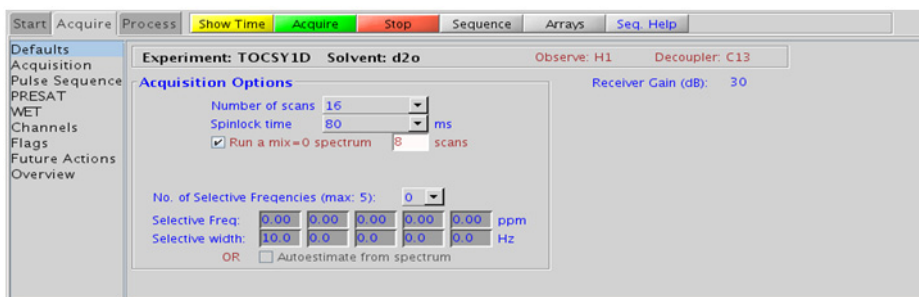

Processing

Same processing as for standard PROTON spectrum. A typical processing apodization choice which provides S/N enhancement (at the expense of resolution) for a 1D spectrum is line broadening, with an lb setting from ~ 0.5 -1 Hz. A suggested optimal value is line broadening equal to the peak linewidth at half-height. Other types of apodization are available under the “Process” tab on the “Weighting” panel.

Tips, tricks, and next steps

- Choosing the TOCSY1D experiment from a previously acquired PROTON data set allows for interactive selection of the peaks for analysis, and the “Default” panel appears differently (see below). Place the cursor(s) on or around the peak and click . Repeat for additional peaks. Results are best if the more isolated peaks are chosen for correlation analysis. It is advisable not to make the widths of the selected peak too narrow as this creates shaped pulses with long durations, which, in turn, can result in some sensitivity loss. The peak of interest does not necessarily have to be centered in the selection window if placing it off-center prevents interference from nearby resonances.

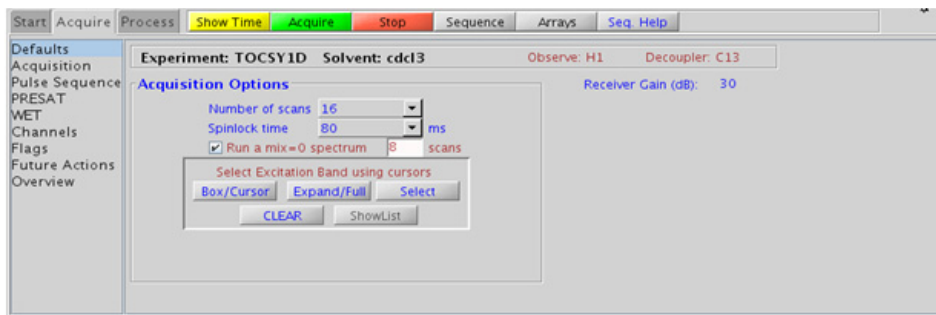

- The zTOCSY1D experiment contains a zero-quantum filter to suppress artifacts and often gives better results than the TOCSY1D.

- The spinlock time ultimately controls how far along the spin system the correlations extend. Use spinlock durations exceeding 150ms with caution, as this can result in sample heating. The efficiency of the TOCSY transfer is directly proportional to the size of the coupling constants between the pairs of protons. To show primarily vicinal and geminal couplings (such as for a COSY), select a shorter spinlock time, for example, 30ms or less.
- The MLEV17 and DIPSI2 spinlock patterns are good choices for small molecules and the DIPSI3 and clean MLEV for larger molecules.
- The sensitivity of the TOCSY1D experiment is not equivalent to a PROTON, nor is an 8-scan TOCSY1D equivalent to an 8-scan, 256-increment TOCSY. Do not hesitate to acquire this experiment with a larger number of scans, particular for weak couplings or extended spin systems.
- When acquiring the TOCSY1D with a larger number of scans, it is advisable to acquire a mixT=0 experiment, to see peaks that appear from any potential pulse imperfections, so as not to mistake them for TOCSY correlations. The mixT=0 spectrum can also be used to confirm the selective excitation occurred as expected, verifying a result from the mixT0 spectrum with no observed TOCSY correlation.
- It is also advisable to run a mixT=0 “reference” spectrum (using , when TOCSY1D is acquired with longer spinlock mixing time. Unlike typical NOESY1D or ROESY1D, the selected resonance (i.e., the originally selected peak) may have intensity similar to the TOCSY peak and hence may not be obviously discernable.

References:

A. Bax, D. G. Davis, J. Magn. Reson. 63 (1985) 355-360. (TOCSY with MLEV17)

J. Cavanaugh, M. Rance, J. Magn. Reson. 96 (1992) 670-678. (TOCSY with DIPSI2)

K. Stott, J. Stonehouse, J. Keeler, T. L. Hwang, A. J. Shaka, J. Am. Chem. Soc. 117 (1995) 4199-4200. (Excitation Sculpting)

zTOCSY1D

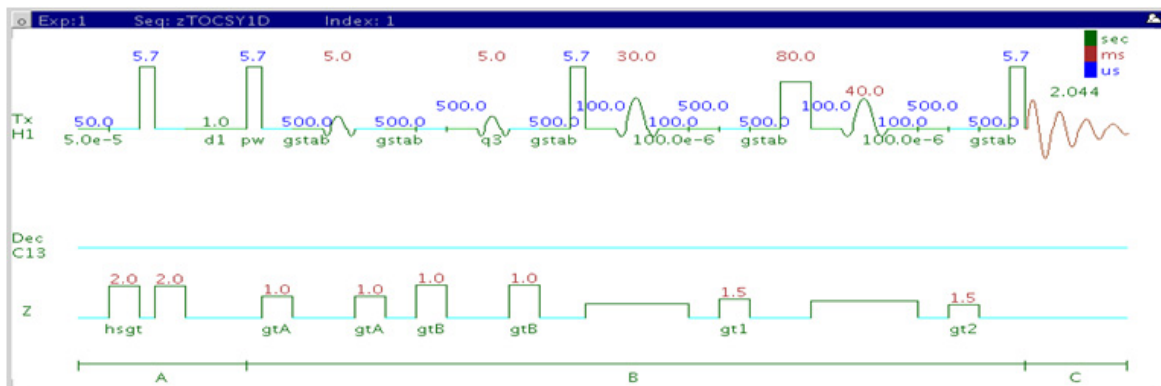

General description and usage

Description:

A pulse sequence to acquire a 1D zTOCSY dataset with a selective pulse to obtain coupling information from a specific frequency.

Usage:

The zTOCSY1D experiment is an important tool for structure elucidation as it can show all protons in a chosen spin system. The selective zTOCSY1D experiment has an advantage over the 2D zTOCSY version for simplifying complicated spectra with a lot of overlapping peaks with invariably shorter total experiment time. If one proton in a given spin system is resolved, selecting this proton for zTOCSY1D analysis produces an edited 1D spectrum containing only the resonances in this spin system. This experiment is most easily set up from a previously acquired PROTON spectrum so the frequencies and bandwidths for zTOCSY1D analysis may be chosen interactively with the cursor. All parameters are set from the "Acquire" tab/"Default" panel unless otherwise specified.

Key parameters

Parameter	Description
Solvent (solvent)	Set from "Start" tab/"Standard" panel
Spectral Width(sw)	Set from previously acquired PROTON*
Number of scans(nt)	Select typical choices from pull down menu*
SpinLock time	Select from pull down menu- 80ms works best for large spin systems*
Run a mix=0 spectrum	Check box to acquire a control spectrum with a mixing time of 0ms- creates an array
No., ppm, width of selective frequencies	Select number of frequencies from the drop down menu. Enter frequency position(s) and bandwidth(s) in the entry boxes
SpinLock Pattern	Pull-down menu on the "Pulse Sequence" panel- DIPS12 works well for small molecules, DIPS13 is a good choice for large molecules

NOTE

You can type specific values for these parameters manually in the appropriate boxes on the "Acquisition" or "Pulse Sequence" panels.

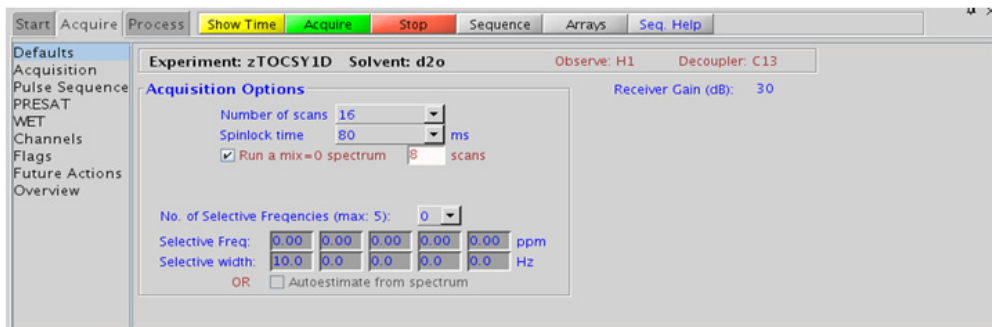

Processing

Same processing as for standard PROTON spectrum. A typical processing apodization choice which provides S/N enhancement (at the expense of resolution) for a 1D spectrum is line broadening, with an lb setting from ~0.5-1 Hz. A suggested optimal value is line broadening equal to the peak linewidth at half-height. Other types of apodization are available under the “Process” tab on the “Weighting” panel.

Tips, tricks, and next steps

- Choosing the zTOCSY1D experiment from a previously acquired PROTON data set allows for interactive selection of the peaks for analysis, and the “Default” panel appears differently (see below). Place the cursor(s) on or around the peak and click . Repeat for additional peaks. Results are best if the more isolated peaks are chosen for correlation analysis. It is advisable not to keep the widths of the selected peak too narrow as it creates shaped pulses with long durations, which, in turn, can result in some sensitivity loss. The peak of interest does not necessarily have to be centered in the selection window if placing it off-center prevents interference from nearby resonances.

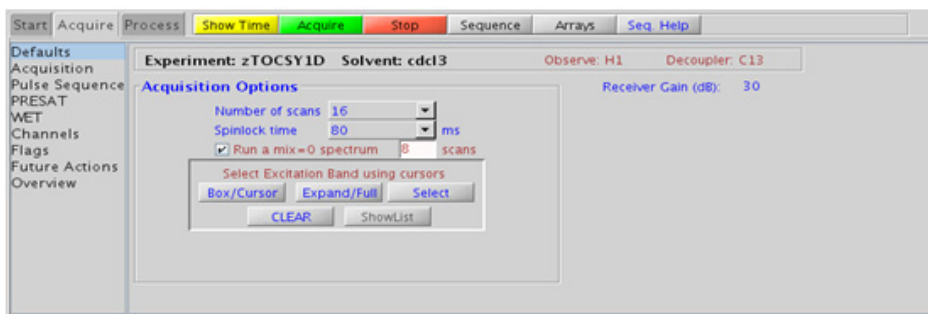

- The zTOCSY1D experiment contains a zero-quantum filter to suppress artifacts and often gives better results than TOCSY1D.

- The spinlock time ultimately controls how far along the spin system the correlations extend. Use spinlock durations exceeding 150ms with caution, as this can result in sample heating. The efficiency of the TOCSY transfer is directly proportional to the size of the coupling constants between the pairs of protons. To show primarily vicinal and geminal couplings (such as for a COSY), select a shorter spinlock time, for example, 30ms or less.
- The DIPSI2 spinlock pattern is a good choice for small molecules and the DIPSI3 for larger molecules.
- The sensitivity of the zTOCSY1D experiment is not equivalent to a PROTON, nor is an 8-scan zTOCSY1D equivalent to an 8-scan, 256-increment zTOCSY. Do not hesitate to acquire this experiment with a larger number of scans, particularly for weak couplings or extended spin systems.
- When acquiring the zTOCSY1D with a larger number of scans, it is advisable to acquire a mixT=0 experiment, to see peaks that appear from any potential pulse imperfections, so as not to mistake them for TOCSY correlations. The mixT=0 spectrum can also be used to confirm the selective excitation occurred as expected, verifying a result from the mixT0 spectrum with no observed TOCSY correlation.
- It is also advisable to run a mixT=0 “reference” spectrum (using , when TOCSY1D is acquired with longer spinlock mixing time. Unlike typical NOESY1D or ROESY1D, the selected resonance (i.e., the originally selected peak) may have intensity similar to the TOCSY peak and hence may not be obviously discernable.

References:

A. Bax, D. G. Davis, J. Magn. Reson. 63 (1985) 355-360. (TOCSY with MLEV17)

J. Cavanaugh, M. Rance, J. Magn. Reson. 96 (1992) 670-678. (TOCSY with DIPSI2)

K. Stott, J. Stonehouse, J. Keeler, T. L. Hwang, A. J. Shaka, J. Am. Chem. Soc. 117 (1995) 4199-4200. (Excitation Sculpting)

M. J. Trippleton, J. Keeler, Angew. Chem. Int. Ed. 42 (2003) 3938-3941. (Zero Quantum Suppression)

selexcit

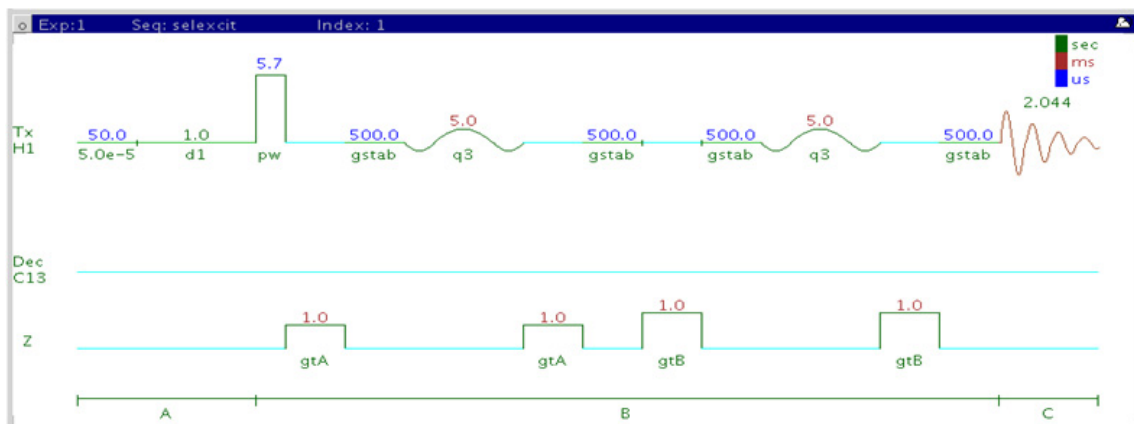

General description and usage

Description:

A pulse sequence to acquire a 1D ^1H dataset with a selective pulse to excite only a portion of the spectrum.

Usage:

The selexcit experiment is most commonly used to set up band-selective 2D experiments (see Chapter 7). It can be used, however, to edit the proton spectrum and improve the dynamic range, when there may be large amounts of impurities and/or solvents signals. An example may be a sample from a biological matrix such as bile, which may have large signals in the aliphatic region and it may be desirable to selectively excite the aromatic region of the spectrum only. This experiment is most easily set up from a previously acquired PROTON spectrum so the frequencies and bandwidths for selective excitation are known, and may be chosen interactively with the cursor. All parameters are set from the “Acquire” tab/”Default” panel unless otherwise specified.

Key parameters

Parameter	Description
Solvent	Set from “Start” tab/“Standard” panel
Spectral Width (sw)	Set from previously acquired proton*
Number of scans	Select typical choices from pull down menu*
No., ppm, width of selective frequencies	Select number of frequencies from the drop down menu. Enter frequency position(s) and bandwidth(s) in the entry boxes

NOTE

You can type specific values for these parameters manually in the appropriate boxes on the “Acquisition” or “Pulse Sequence” panels.

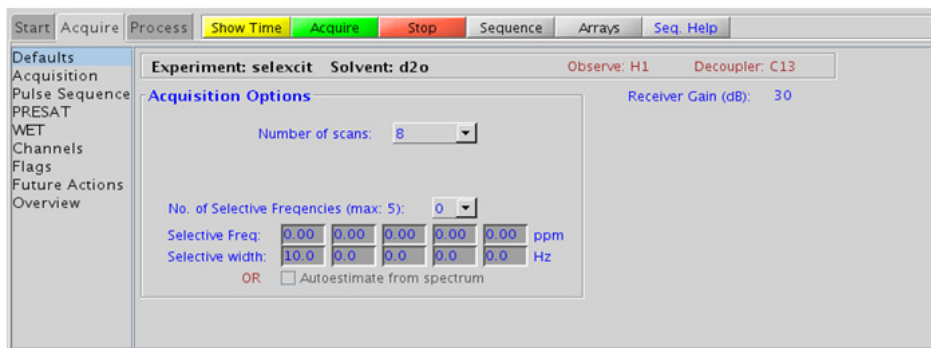

Processing

Same processing as for standard PROTON spectrum. A typical processing apodization choice which provides S/N enhancement (at the expense of resolution) for a 1D spectrum is line broadening, with an lb setting from ~0.5-1 Hz. A suggested optimal value is line broadening equal to the peak linewidth at half-height. Other types of apodization are available under the “Process” tab on the “Weighting” panel.

Tips, tricks, and next steps

- Choosing the selexcit experiment from a previously acquired PROTON data set allows for interactive selection of the peaks for analysis, and the “Default” panel appears differently (see below). Place the cursor(s) on or around the peak and click . Repeat for additional peaks. Results are best if the more isolated peaks are chosen for correlation analysis. It is advisable not to make the widths of the selected peak too narrow as this creates shaped pulses of long durations, which, in turn, can result in some sensitivity loss. The peak of interest does not necessarily have to be centered in the selection window if placing it off-center prevents interference from nearby resonances from being selected.

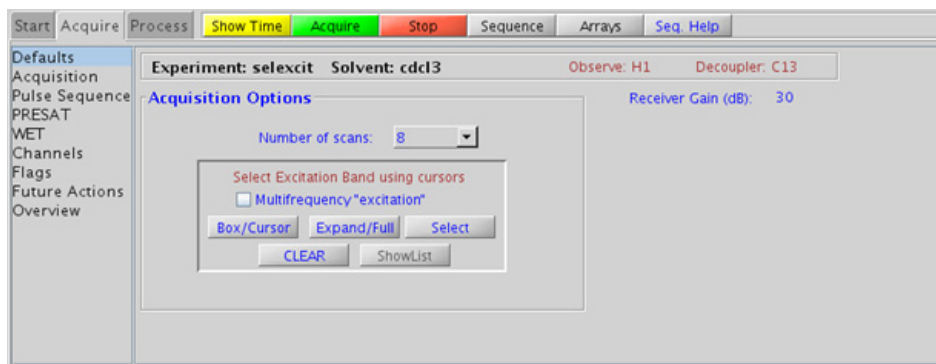

- The selexcit experiment has a check option to do multifrequency excitation. Choosing multiple bands (interactively from the PROTON spectrum) with this check box “ON” results in a single spectrum wherein all of the selected bands are included. However, selection of multiple bands with this check box “OFF” results in multiple spectra each with a single selected band.
- The sensitivity of the selexcit experiment is usually not equivalent to a PROTON, due to some potential loss from the selective pulse.
- Setting up the desired regions from a selexcit experiment is the easiest way to configure a band-selective 2D experiment (see Chapter 7).

References:

K. Stott, J. Stonehouse, J. Keeler, T. L. Hwang, A. J. Shaka, J. Am. Chem. Soc. 117 (1995) 4199-4200. (Excitation Sculpting)

stepNOESY1D

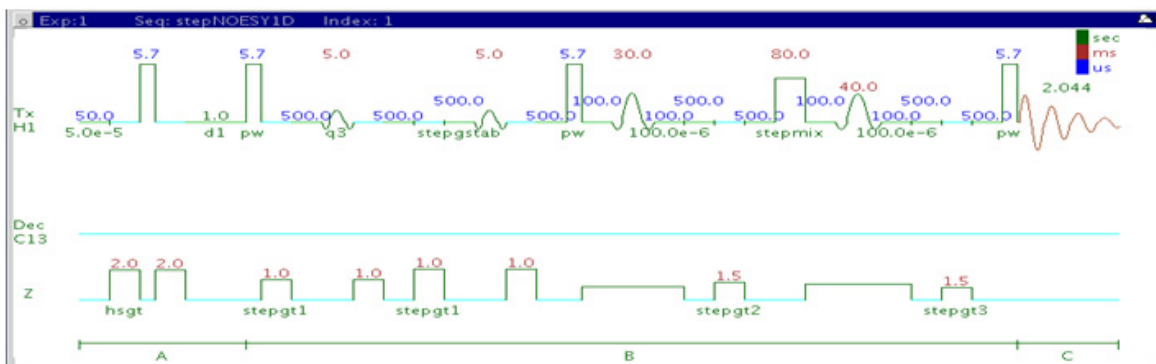

General description and usage

Description:

A pulse sequence to acquire a 1D TOCSYNOESY dataset with a selective pulse to obtain TOCSYNOESY information from a specific frequency. It is effectively a 1D equivalent of a 3D experiment.

Usage:

The stepNOESY1D experiment first acquires a TOCSY1D on a selected peak from a PROTON spectrum, and then performs a NOESY1D on one of the TOCSY correlations. This experiment, while somewhat insensitive, can be helpful to simplify and obtain subspectra of impure samples and/or complex spectra when there is one resolved peak from the desired molecule of interest. This is a unique method to obtain NOE information from completely obscured protons in a complex molecule. This experiment is most easily set up from a previously acquired PROTON spectrum so the frequencies for the TOCSY and subsequent NOE analysis are chosen interactively with the cursor. All parameters are set from the "Acquire" tab/"Default" panel unless otherwise specified.

Key parameters

Parameter	Description
Solvent (solvent)	Set from "Start" tab/"Standard" panel
Spectral Width(sw)	Set from previously acquired PROTON*
Number of scans(nt)	Select typical choices from pull down menu*
TOCSY STEP ON/OFF	Check box to turn off TOCSY to set up STEP band (turn off NOE also); turn on for analysis
STEP mixing time	Select from pull down menu- 80ms works best for large spin systems*
Set STEP band, STEP peak (ppm), width (Hz)	Select desired TOCSY correlation with cursor type in ppm/width, click "Select and makeshape" button
NOE ON/OFF	Check box to turn off NOE to set up NOE band; turn on for analysis
NOE mixing time	Select from pull down menu- 500ms works best well for most small molecules*
Set NOE band	Select desired TOCSY correlation with cursors, click "Select and makeshape button"

NOTE

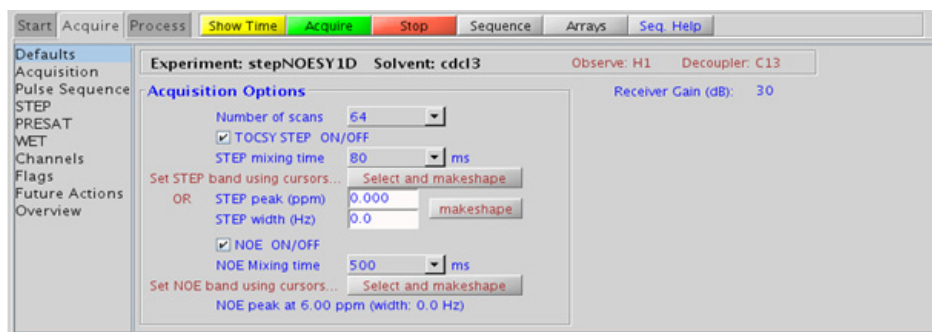

You can type specific values for these parameters manually in the appropriate boxes on the "Acquisition" or "Pulse Sequence" panels.



Processing

Same processing as for standard PROTON spectrum, except that manual phasing may be required as the NOE peaks may be negative for smaller molecules. A typical processing apodization choice which provides S/N enhancement (at the expense of resolution) for a 1D spectrum is line broadening, with an lb setting from ~ 0.5 -1 Hz. A suggested optimal value is line broadening equal to the peak linewidth at half-height. Other types of apodization are available under the “Process” tab on the “Weighting” panel.

Tips, tricks, and next steps

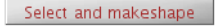
- The STEP band for the TOCSY may be selected from a previously acquired PROTON dataset, or a quick stepNOESY1D experiment with the TOCSY STEP and NOE off can be used to acquire a quick sample spectrum. Place the cursor(s) on or around the peak to be selected and click . Alternatively, the frequency (ppm) and width (Hz) for the STEP peak may be entered in the boxes provided and  clicked. The NOE band may also be selected from a previously acquired TOCSY1D or zTOCSY1D spectrum. Alternately, a quick stepNOESY1D experiment with the TOCSY STEP on and NOE off can be acquired and used for NOE band selection. Place the cursor(s) on or around the peak to be selected and click . It is advisable to not keep the widths of the selected peaks too narrow, as it creates shaped pulses with long durations, which can, in turn, result in some sensitivity loss. The peak of interest does not necessarily have to be centered in the selection window if placing it off-center prevents interference from nearby resonances.
- Use spinlock (STEP mixing time) durations exceeding 150ms with caution as this can result in sample heating. The efficiency of the TOCSY transfer is directly proportional to the size of the coupling constants between the pairs of protons. A STEP mixing time of 30-80ms is typical for most small molecules, depending on the length of the coupling network and the size of the intervening coupling constants. An 80ms STEP mixing time is a good choice for molecules with extended spin systems.

- The TOCSY spinlock pattern can be selected from the “STEP” tab. The DIPSI2 spinlock pattern is a good choice for small molecules and the DIPSI3 is typically used for larger molecules.
- A mixing time for the NOE of 500ms is a good starting place for most small molecules. Very small molecules and/or weak NOE interactions may require longer mixing times (up to ~1s). Longer mixing times, however, increase the possibility of spin diffusion for larger molecules, a situation where the magnetization is transferred through space, and then through coupling, resulting in spurious correlations between protons. As in NOESY1D, the NOE correlation can be confirmed by acquiring a build-up curve, whereby the mixing time is slowly increased in 50-100ms increments until the NOE intensity ceases to increase and levels off. This is the optimal mixing time. In addition, the slope of such a build up curve can be used to determine bond distances between selected spin pairs (using methods such as PANIC).
- The sensitivity of the stepNOESY1D experiment is quite low, as it is essentially a 1D equivalent of a 3D experiment, which typically takes a long time to acquire. Do not hesitate to acquire this experiment with a larger number of scans. It may also be helpful to optimize the STEP and NOE mixing times with TOCSY1D and NOESY1D experiments before acquiring the stepNOESY1D.

References:

H. Hu, S. Bradley, K. Krishnamurthy, J. Magn. Reson., 171 (2004), 201 (STEPNOESY1D)

S. Macura, Y. Huang, D. Suter, R. R. Ernst, J. Magn. Reson. 43 (1981) 259-281. (NOESY)

K. Stott, J. Stonehouse, J. Keeler, T. L. Hwang, A. J. Shaka, J. Am. Chem. Soc. 117 (1995) 4199-4200. (Excitation Sculpting)

M. J. Trippleton, J. Keeler, Angew. Chem. Int. Ed. 42 (2003) 3938-3941. (Zero Quantum Suppression)

6 Selective 1D - (H)Sel1D
Tips, tricks, and next steps



7 Selective 2D - Sel2D

Sel2D Tab	250
(HC)bsHSQCAD	252
(HC)bsgHSQCAD	256
(HC)bsgHMBC	260
(HC)EXSIDE	264
(HC)bsHSQCNOESY	268
(HC)bsHSQCROESY	274
(HH)bsROESY	280
(HH)bsTOCSY	284
(HH)bsNOESY	288



Sel2D Tab

The experiments in the “Sel2D tab” are F1 band-selected 2D experiments. Band-selection in the F1 dimension saves time and improves resolution in any 2D experiment by reducing the number of increments needed in that dimension, while allowing the operator to focus on the correlation region of interest. In the heteronuclear experiments this can be especially useful for resolving nearly-degenerate ^1H - ^{13}C resonances into unambiguous correlations. With homonuclear spectra it can shed light, for example, into a crowded aromatic region of a NOESY. Such high resolution in the traditional (broadband version) experiment can only be obtained at the cost a very high number of increments (and hence spectrometer time).

The homonuclear experiments include (HH)bsROESY, (HH)bsTOCSY, and (HH)bsNOESY. All of these experiments are setup either from a PROTON spectrum, a selexcit experiment (selective 1D), or by simple entry of the desired F1 region in the setup panels. All necessary selective pulses are created automatically and the parameters set appropriately. The homonuclear experiments support the option for broadband homonuclear decoupling in the F1 dimension, thereby further improving resolution.

The heteronuclear experiments are proton-carbon by default, with ^{13}C as the band-selected dimension. If the selective 2D experiment is setup from a traditional 2D data set of the same type, for example, HSQC or HMBC, the operator can choose the band-selected frequencies with cursors from the existing spectra. Alternatively, the desired F1 window can be chosen by entering the desired region into the parameter entries. All required shaped pulses are created automatically.

There are two experiments that only appear in the Sel2D tab, (HC)bsHSQCNOESY and (HC)bsHSQCROESY. Because the F1 window can be customized, the HSQCNOESY/ROESY is available for a wide range of structural problems. The information conveyed is similar to the HetToxy family of experiments, for example, “proton A has NOE to a proton B, whose carbon is at that chemical shift”, but with the potential of added resolution for the carbon shifts.

The (HC)EXSIDE is an experiment that provides a method to measure long-range H/C coupling constants. Typically the (HC)EXSIDE is setup from a selexcit experiment, where the multi-band option is used to select

all desired protons, taking care to exclude pairs from the same spin system. The coupling constants are seen as in-phase pairs in the F1 dimension, scaled up by a J-scaling parameter.

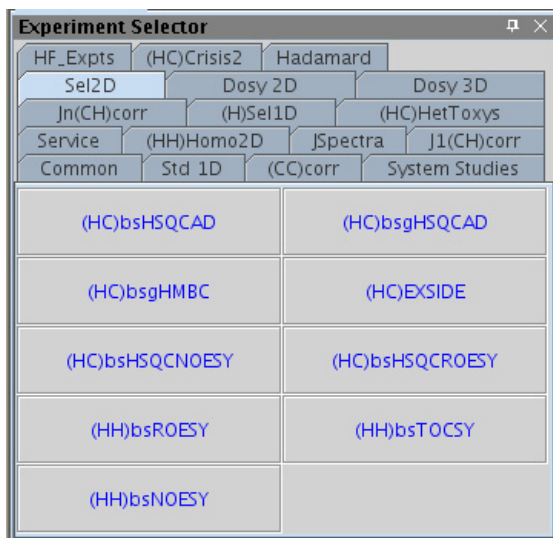

(HC)bsHSQCAD

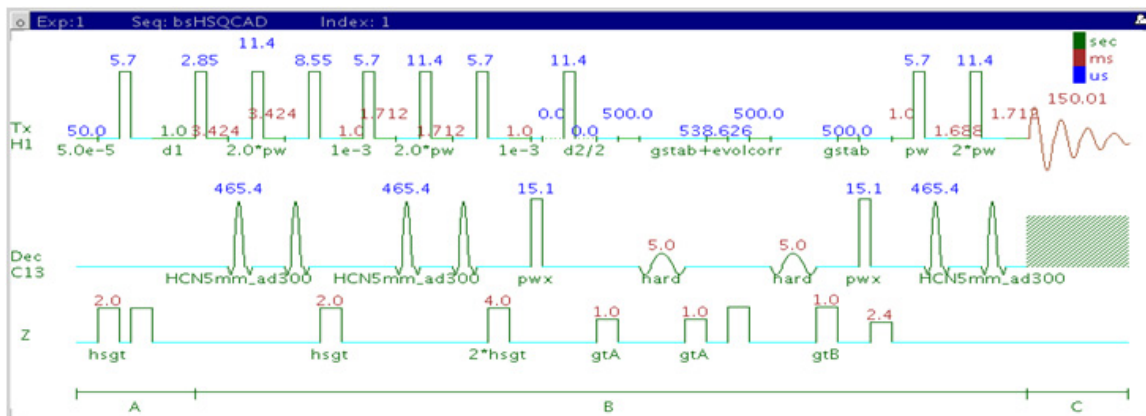

General description and usage

Description:

Two Dimensional heteronuclear single-quantum 1-bond J-correlation spectroscopy with adiabatic 180° X-nuclei pulses and band-selection in F1.

Usage:

The (HC)bsHSQCAD experiment is used to acquire a 2-dimensional spectrum to correlate protons to directly attached carbons in a band-selected region along F1. Using band-selection is an efficient way to increase the resolution in the F1 carbon dimension without adding large numbers of increments and, hence, experiment time. The selected band can either be typed in or chosen interactively from a previously acquired HSQC-type experiment. All parameters are set from the “Acquire” tab/”Defaults” panel unless otherwise specified.

Key parameters

Parameter	Description
Spectral Width (sw)	Set from previously acquired PROTON*
Acquisition time (at)	Set from "Pulse Sequence" panel, controls the resolution in F2, default 0.15s
F1 Nucleus (dn)	Pull- down menu to set F1 nucleus to ^{13}C , ^{15}N , or other
C13 Spectral Width (ppm)	Type in desired chemical shift range for F1 dimension or check box to select interactively from previously acquired HSQC-type experiment
Scans per t1 increment (nt)	Select typical choices from pull down menu*
t1 Increments (ni)	Select typical choices from pull down menu* - controls the resolution in F1
One-Bond J1xh (j1xh)	Set value for the average $^1\text{J}_{\text{X,H}}$ - 146 Hz works well for many carbons
Steady State (ss)	Set from "Pulse Sequence" panel, turn on/off gradient cleanup between scans
C12-H1 suppression	Set from "Pulse Sequence" panel- check box to turn on/off TANGO-Gradient ^{12}C suppression (default is on- highly recommended)

NOTE

You can type specific values for these parameters manually in the appropriate boxes on the "Acquisition" panel.

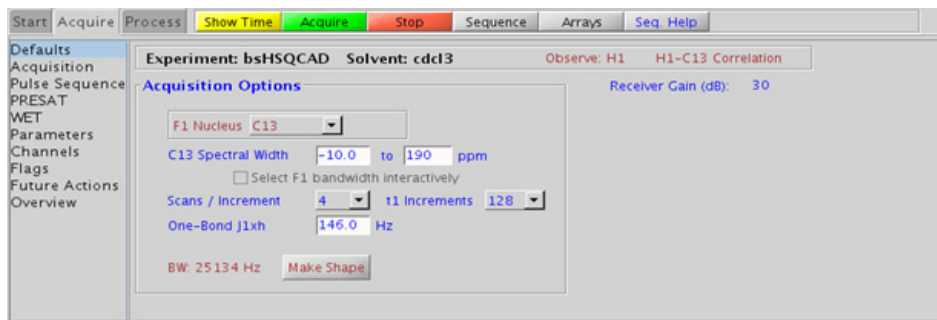

Processing

Automated processing is turned on by default, and the parameters are set to reasonable values, such that the resulting data after the acquisition usually require no further adjustment. The “Process” tab/“Basic” panel contains many of the commonly modified processing parameters, such as a pull-down menu to change the FT data size (1k x 1k is the default), as well as a check box to turn on/off linear prediction and a pull-down to control the extent of linear prediction (default is 4*ni). Menus to quickly change the weighting functions in F2/F1 are also present (defaults are gaussians); the parameters for the weighting functions are calculated automatically from the acquisition time and number of increments. More processing details are found under some of the other “Process” panels, such as the “Default”, “Weighting”, and “More 2D” panels.

Tips, tricks, and next steps

- Spectral width (sw) setting transfers from a PROTON if the (HC)bsHSQCAD is set up from this experiment. All HSQC-related parameters transfer if the experiment is set up from a previously acquired HSQC-type experiment and the F1 band may be selected interactively. Receiver gain (gain) is usually set to a high value (≥ 30), unless the sample is extremely concentrated or ^{13}C -labelled.

- To measure ^1H - ^{13}C (or ^1H -X) coupling constants, the carbon decoupling can be turned off by entering “nnn” in the Channel 2 “Dec On/Off” entry on the “Channels” panel or alternatively by typing dm='nnn' on the command line.
- The default number of steady state scans (ss) that are acquired before data acquisition to establish sample equilibrium is 32, which works for most samples. However, higher power carbon decoupling may cause some perturbations that may necessitate more ss scans to reach equilibrium. This value is changed on the “Acquisition” panel of the “Acquire” tab if necessary.
- The default parameters use a Grad-90-Grad steady state between scans, which helps cleanup un-relaxed magnetization. This can result in much cleaner spectra, especially when using shorter acquisition times (at) and relaxation delays (d1) (defaults are 0.15s and 1s, respectively).
- The (HC)bsHSQCAD experiment has a sensitivity advantage (factor of ~ 1.4) over the (HC)bsgHSQCAD, but may produce potentially less clean spectra (due to t1 noise from strong signals such as t-butyl) than its gradient counterpart.

References:

G. Bodenhausen, D. J. Ruben, Chem. Phys. Lett. 69 (1980) 185-189.
(HSQC)

E. Kupce, R. Freeman, J. Magn. Reson. Ser. A 117 (1995) 246-256.
(Adiabatic Pulses)

C. Gaillet, C. Liquart, P. Deberie, J. M. Nuzillard, J. Magn. Reson. 139 (1999) 454-459. (Band Selective HSQC/HMBC)

(HC)bsgHSQCAD

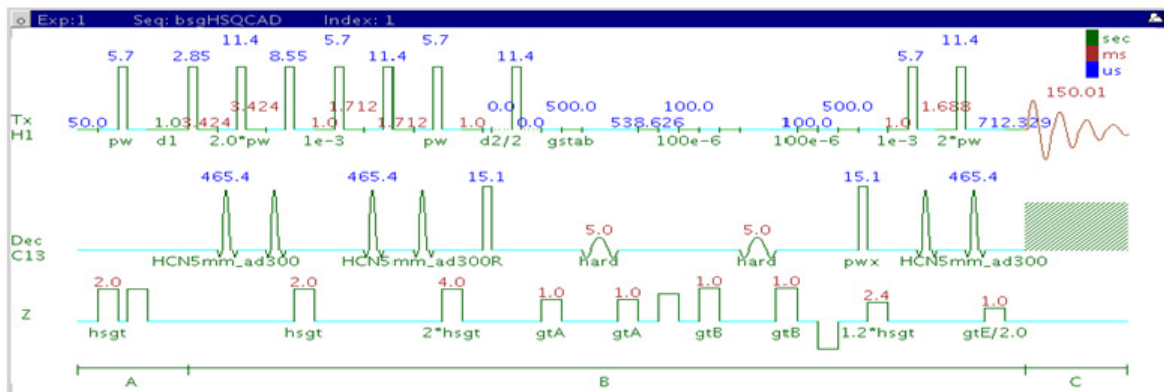

General description and usage

Description:

Two Dimensional heteronuclear single-quantum 1-bond J-correlation spectroscopy with adiabatic 180° X-nuclei pulses, gradient coherence selection, and band-selection in F1.

Usage:

The (HC)bsgHSQCAD experiment is used to acquire a 2-dimensional spectrum to correlate protons to directly attached carbons in a band-selected region along F1. Using band-selection is an efficient way to increase the resolution in the F1 carbon dimension without adding large numbers of increments and, hence, experiment time. The selected band can either be typed in or chosen interactively from a previously acquired HSQC-type experiment. All parameters are set from the "Acquire" tab/"Defaults" panel unless otherwise specified.

Key parameters

Parameter	Description
Spectral Width (sw)	Set from previously acquired PROTON*
Acquisition time (at)	Set from "Pulse Sequence" panel, controls the resolution in F2, default 0.15s
F1 Nucleus (dn)	Pull- down menu to set F1 nucleus to ^{13}C , ^{15}N , or other
C13 Spectral Width (ppm)	Type in desired chemical shift range for F1 dimension or check box to select interactively from previously acquired gHSQCAD
Scans per t1 increment (nt)	Select typical choices from pull down menu*
t1 Increments (ni)	Select typical choices from pull down menu*- controls the resolution in F1
One-Bond J1xh (j1xh)	Set value for the average $^1J_{\text{X,H}}$ - 146 Hz works well for many carbons
Steady State (ss)	Set from "Pulse Sequence" panel, turn on/off gradient cleanup between scans
C12-H1 suppression	Set from "Pulse Sequence" panel- check box to turn on/off TANGO-Gradient ^{12}C suppression (default is on- highly recommended)

NOTE

You can type specific values for these parameters manually in the appropriate boxes on the "Acquisition" panel.

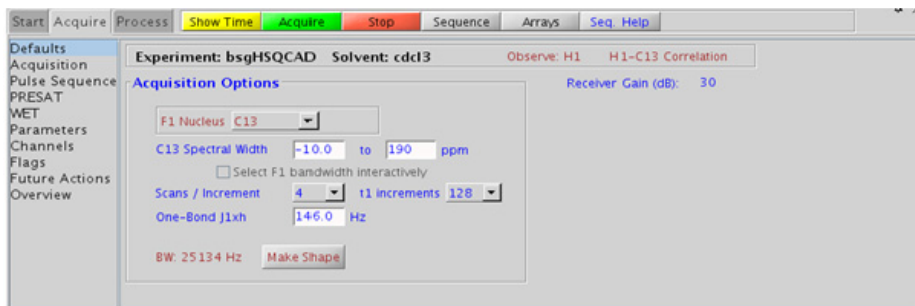

Processing

Automated processing is turned on by default, and the parameters are set to reasonable values, such that the resulting data after the acquisition usually require no further adjustment. The “Process” tab/“Basic” panel contains many of the commonly modified processing parameters, such as a pull-down menu to change the FT data size (1k x 1k is the default), as well as a check box to turn on/off linear prediction and a pull-down to control the extent of linear prediction (default is 4*ni). Menus to quickly change the weighting functions in F2/F1 are also present (defaults are gaussians); the parameters for the weighting functions are calculated automatically from the acquisition time and number of increments. More processing details are found under some of the other “Process” panels, such as the “Default”, “Weighting”, and “More 2D” panels.

Tips, tricks, and next steps

- Spectral width (sw) setting transfers from a PROTON if the (HC)bsgHSQCAD is set up from this experiment. All HSQC-related parameters transfer if the experiment is set up from a previously acquired HSQC-type experiment and the F1 band may be selected interactively. Receiver gain (gain) is usually set to a high value (≥ 30), unless the sample is extremely concentrated or ^{13}C -labelled.
- To measure ^1H - ^{13}C (or ^1H -X) coupling constants, the carbon decoupling can be turned off by entering “nnn” in the Channel 2 “Dec On/Off” entry on the “Channels” panel or alternatively by typing dm='nnn' on the command line.
- The default number of steady state scans (ss) that are acquired before data acquisition to establish sample equilibrium is 32, which works for most samples. However, higher power carbon decoupling may cause some perturbations that may necessitate more ss scans to reach equilibrium. This value is changed on the “Acquisition” panel of the “Acquire” tab if necessary.
- The default parameters use a Grad-90-Grad steady state between scans, which helps cleanup un-relaxed magnetization. This can result in much cleaner spectra, especially when using shorter acquisition times (at) and relaxation delays (d1) (defaults are 0.15s and 1s, respectively).

- The (HC)bsHSQCAD experiment has a sensitivity advantage (factor of ~ 1.4) over the (HC)bsgHSQCAD, but may produce potentially less clean spectra (due to t_1 noise from strong signals such as t-butyl) than its gradient counterpart.

References:

G. Bodenhausen, D. J. Ruben, Chem. Phys. Lett. 69 (1980) 185-189.
(HSQC)

E. Kupce, R. Freeman, J. Magn. Reson. Ser. A 117 (1995) 246-256.
(Adiabatic Pulses)

C. Gaillet, C. Liguart, P. Deberie, J. M. Nuzillard, J. Magn. Reson. 139
(1999) 454-459. (Band Selective HSQC/HMBC)

(HC)bsgHMBC

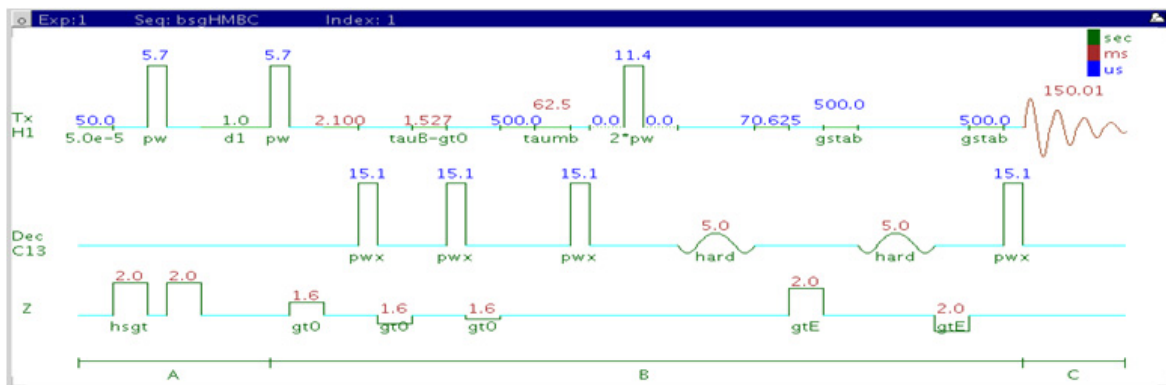

General description and usage

Description:

Two Dimensional heteronuclear multiple-bond J-correlation spectroscopy with gradient coherence selection and band-selection in F1.

Usage:

The (HC)bsgHMBC experiment is used to acquire a 2-dimensional spectrum to correlate protons to carbons in a band-selected region along F1, usually over 2-3 bonds with the 3-bond correlations typically being stronger. Using band-selection is an efficient way to increase the resolution in the F1 carbon dimension without adding large numbers of increments and, hence, experiment time. The selected band can either be typed in or chosen interactively from a previously acquired HSQC- or HMBC-type data set. All parameters are set from the “Acquire” tab/”Defaults” panel unless otherwise specified.

Key parameters

Parameters	Description
Spectral Width (sw)	Set from previously acquired PROTON*
Acquisition time (at)	Set from "Pulse Sequence" panel, controls the resolution in F2, default 0.15s
F1 Nucleus (dn)	Pull- down menu to set F1 nucleus to ^{13}C , ^{15}N , or other*
C13 Spectral Width (ppm)	Type in desired chemical shift range for F1 dimension or check box to select interactively from previously acquired (CH) correlation experiment
Scans per t1 increment (nt)	Select typical choices from pull down menu*
t1 Increments (ni)	Select typical choices from pull down menu* - controls the resolution in F1 (minimum ~64)
Multiple-Bond Jn _{xh} (jnxh)	Pull-down menu to set value for the average $^n\text{J}_{\text{X,H}}$ - 8 Hz works well for most molecules
One-Bond suppression	Set from "Pulse Sequence" panel- turn on/off suppression of one-bond correlations- default is on
Steady State (ss)	Set from "Pulse Sequence" panel, turn on/off gradient cleanup between scans

NOTE

You can type specific values for these parameters manually in the appropriate boxes on the "Acquisition" or "Pulse Sequence" panels.

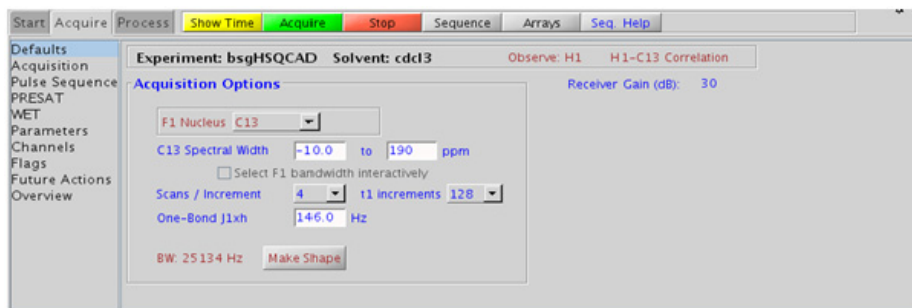

Processing

Automated processing is turned on by default, and the parameters are set to reasonable values, such that the resulting data after the acquisition usually require no further adjustment. The “Process” tab/“Basic” panel contains many of the commonly modified processing parameters, such as a pull-down menu to change the FT data size (2k x 1k is the default), as well as a check box to turn on/off linear prediction and a pull-down to control the extent of linear prediction (default is 4*ni). Menus to quickly change the weighting functions in F2/F1 are also present (defaults are gaussian in F1 and sqsinebell in F2); the parameters for the weighting functions are calculated automatically from the acquisition time and number of increments. More processing details are found under some of the other “Process” panels, such as the “Default”, “Weighting”, and “More 2D” panels. It is important to note that this experiment employs mix-mode processing, with the F2 dimension absolute value and F1 phase-sensitive. This arrangement allows for the best resolution and sensitivity combination.

Tips, tricks, and next steps

- Spectral width (sw) setting transfers from a PROTON if the (HC)bsgHMBC is set up from this experiment. All HMBC-related parameters transfer if the experiment is set up from a previously acquired HMBC-type experiment and the F1 band may be selected interactively. Receiver gain (gain) is usually set to a high value (≥ 30), unless the sample is extremely concentrated or ^{13}C -labelled.
- The default number of steady state scans (ss) that are acquired before data acquisition to establish sample equilibrium is 32, which works for most samples. This value is changed on the “Acquisition” panel of the “Acquire” tab if necessary.
- The default parameters use a Grad-90-Grad steady state between scans, which helps cleanup un-relaxed magnetization. This can result in much cleaner spectra, especially when using shorter acquisition times (at) and relaxation delays (d1) (defaults are 0.15s and 1s, respectively).

- The experiment features a 2-step low-pass filter that can eliminate undesired crosspeaks from one-bond couplings. Select two coupling constants on the “Pulse Sequence” panel around which one-bond couplings are eliminated (default values are 165 and 130 Hz). These filters are rather narrow-band, however, and if the spread of coupling constants is such that some couplings lie considerably outside these values (for example 115 or 145 Hz), its signals may still be visible in the spectrum. As HMBC-type spectra are recorded without ¹³C decoupling, such signals can usually still be discerned from long-range crosspeaks by their one-bond splitting.
- The jnxh sets the optimal value of the proton-carbon coupling constant for detection. Using smaller values may increase the chances of seeing longer-range correlations, but at the expense of correlations with larger coupling constants, and, more importantly, at the expense of sensitivity.

References:

- A. Bax, M. F. Summers, *J. Am. Chem. Soc.* 108 (1986) 2093-2094. (HMBC)
- E. Kupce, R. Freeman, *J. Magn. Reson. Ser. A* 117 (1995) 246-256. (Adiabatic Pulses)
- C. Gaillet, C. Liguart, P. Deberie, J. M. Nuzillard, *J. Magn. Reson.* 139 (1999) 454-459. (Band Selective HSQC/HMBC)

(HC)EXSIDE

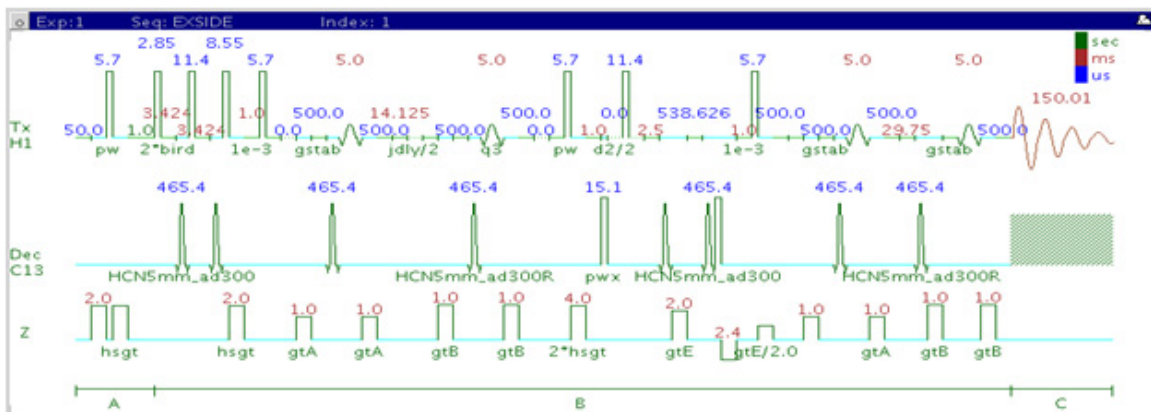

General description and usage

Description:

Two Dimensional band-selective HSQC-type experiment for measuring long-range ^1H - ^{13}C coupling constants.

Usage:

The (HC)EXSIDE experiment is used primarily to obtain information about long-range ^1H - ^{13}C coupling constants. Setup is from a previously acquired selexcit experiment. The data appears as a 2D 1-bond ^1H - ^{13}C correlation with proton chemical shifts in F2 and carbon in F1. The long-range ^1H - ^{13}C coupling constants are measured from in-phase pairs in the F1 dimension scaled up by the j-scaling factor. The specific advantage of (HC)EXSIDE in measuring long-range coupling constants is that (i) they are measured along F1 as doublets with the peak separation scaled by a user definable scaling factor and (ii) only the heteronuclear active coupling is observed without any interference from ^1H - ^1H homonuclear couplings. Proton-carbon coupling constants are often used to help define

e/z stereochemistry of double bonds or molecular conformations, for example, the torsion angles of peptides. All parameters are set from the “Acquire” tab/“Defaults” panel unless otherwise specified.

Key parameters

Parameters	Description
Spectral Width (sw)	Set from previously acquired selexcit
Acquisition time (at)	Set from “Pulse Sequence” panel, controls the resolution in F2, default 0.15s
F1 Nucleus (dn)	Pull- down menu to set F1 nucleus to ^{13}C , ^{15}N , or other*
C13 Spectral Width (ppm)	Type in desired chemical shift range for F1 dimension
Scans per t1 increment (nt)	Select typical choices from pull down menu*
t1 Increments (ni)	Select typical choices from pull down menu* - controls the resolution in F1 (minimum ~64)
n-Bond jxh (jnxh)	Pull-down menu to set value for the average $^n\text{J}_{\text{X,H}}$ - 8 Hz works well for most molecules
J-scale (jscale)	Scaling factor for the coupling constants in F1
One-Bond suppression	Set from “Pulse Sequence” panel- turn on/off suppression of one-bond correlations- default is on
Steady State (ss)	Set from “Pulse Sequence” panel, turn on/off gradient cleanup between scans

NOTE

You can type specific values for these parameters manually in the appropriate boxes on the “Acquisition” or “Pulse Sequence” panels.

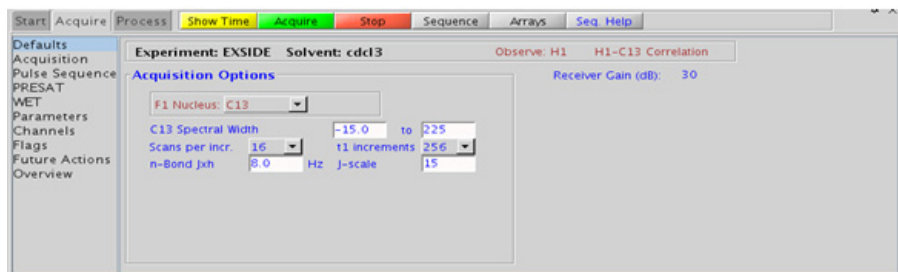

Processing

Automated processing is turned on by default, and the parameters are set to reasonable values, such that the resulting data after the acquisition usually require no further adjustment. The “Process” tab/“Basic” panel contains many of the commonly modified processing parameters, such as a pull-down menu to change the FT data size (2k x 1k is the default), as well as a check box to turn on/off linear prediction and a pull-down to control the extent of linear prediction (default is 4*ni). Menus to quickly change the weighting functions in F2/F1 are also present (defaults are gaussians); the parameters for the weighting functions are calculated automatically from the acquisition time and number of increments. More processing details are found under some of the other “Process” panels, such as the “Default”, “Weighting”, and “More 2D” panels.

Tips, tricks, and next steps

- This experiment is setup from a previously acquired selexcit experiment. Select the multi-band option and choose all desired protons, taking care to select only protons which do not share a mutual homonuclear coupling. Ideally, a COSY-type experiment is acquired and used to guide selection of resonances (not coupled to each other) for the selexcit. If heteronuclear coupling constants need to be determined from two mutually coupled protons, two EXSIDE experiments must be acquired. Receiver gain (gain) is usually set to a high value (≥ 30), unless the sample is extremely concentrated or ^{13}C -labelled.

- The default number of steady state scans (ss) that are acquired before data acquisition to establish sample equilibrium is 32, which works for most samples. This value is changed on the “Acquisition” panel of the “Acquire” tab if necessary.
- The default parameters use a Grad-90-Grad steady state between scans, which helps cleanup un-relaxed magnetization. This can result in much cleaner spectra, especially when using shorter acquisition times (at) and relaxation delays (d1) (defaults are 0.15s and 1s, respectively).
- The jnxh parameter sets the optimal value of the proton-carbon coupling constant for detection.
- Proton-carbon long range coupling constants are often used to help define *e/z* stereochemistry of double bonds or molecular conformations, for example, the torsion angles of peptides.

References:

V. V. Krishnamurthy, J. Magn. Reson. Ser. A121 (1996) 33-41. (EXSIDE)

(HC)bsHSQCNOESY

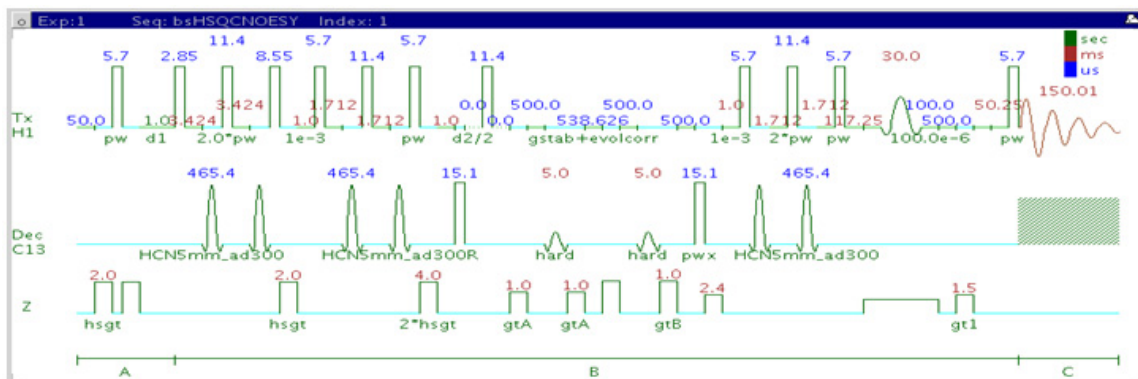

General description and usage

Description:

Two dimensional heteronuclear single-quantum 1-bond J-correlation spectroscopy with the addition of a noesy mixing time. Contains adiabatic 180° X-nuclei pulses and band-selection in F1.

Usage:

The (HC)bsHSQCNOESY experiment is used to acquire a 2-dimensional spectrum to collect information correlating NOE and carbon chemical shift information, for example, Proton A has an NOE to proton B at carbon chemical shift X. The band-selection along the F1 dimension gives the (HC)bsHSQCNOESY an advantage of better resolution than a non-selective HSQCNOESY. The selected band can either be typed in or chosen interactively from a previously acquired HSQC-type spectrum. All parameters are set from the "Acquire" tab/"Defaults" panel unless otherwise specified.

Key parameters

Parameters	Description
Spectral Width (sw)	Set from previously acquired PROTON*
Acquisition time (at)	Set from "Pulse Sequence" panel, controls the resolution in F2, default 0.15s
F1 Nucleus (dn)	Pull- down menu to set F1 nucleus to ^{13}C , ^{15}N , or other*
C13 Spectral Width (ppm)	Type in desired chemical shift range for F1 dimension or check box to select interactively from previously acquired gHSQCAD
Scans per t1 increment (nt)	Select typical choices from pull down menu*
t1 Increments (ni)	Select typical choices from pull down menu*- controls the resolution in F1 (minimum ~64)
One-Bond J1xh (j1xh)	Set value for the average $^1J_{\text{X,H}}$ - 146 Hz works well for many carbons
NOE Mixing time (mixN)	Select from pull down menu- 500ms works well as a starting point*
Steady State (ss)	Set from second "Pulse Sequence" panel, turn on/off gradient cleanup between scans
C12-H1 suppression	Set from "Pulse Sequence" panel- controls type of ^{12}C suppression- default is TANGO-Gradient (highly recommended)

NOTE

You can type specific values for these parameters manually in the appropriate boxes on the "Acquisition" or "Pulse Sequence" panels.

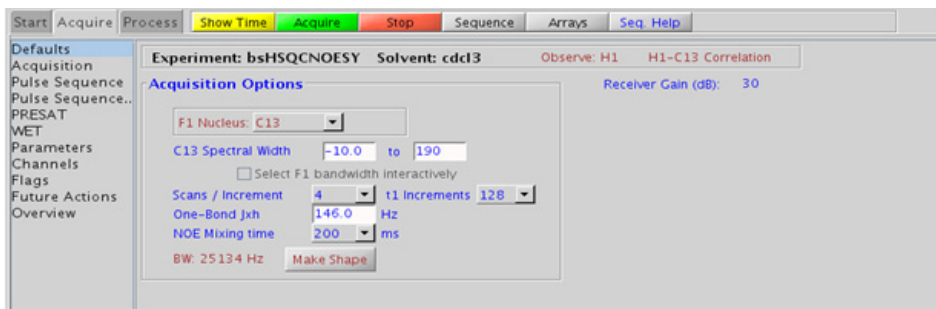

Processing

Automated processing is turned on by default, and the parameters are set to reasonable values, such that the resulting data after the acquisition usually require no further adjustment. The “Process” tab/“Basic” panel contains many of the commonly modified processing parameters, such as a pull-down menu to change the FT data size (1k x 1k is the default), as well as a check box to turn on/off linear prediction and a pull-down to control the extent of linear prediction (default is 4*ni). Menus to quickly change the weighting functions in F2/F1 are also present (defaults are gaussians); the parameters for the weighting functions are calculated automatically from the acquisition time and number of increments. More processing details are found under some of the other “Process” panels, such as the “Default”, “Weighting”, and “More 2D” panels.

Tips, tricks, and next steps

- Spectral width (sw) setting transfers from a PROTON if the (HC)bsHSQCNOESY is set up from this experiment. All HSQC-related parameters transfer if the experiment is set up from a previously acquired HSQC-type experiment and the F1 band may be selected interactively. Receiver gain (gain) is usually set to a high value (≥ 30), unless the sample is extremely concentrated or ^{13}C -labelled.

- The default number of steady state scans (ss) that are acquired before data acquisition to establish sample equilibrium is 32, which works for most samples. However, higher power carbon decoupling may cause some perturbations that may necessitate more ss scans to reach equilibrium. This value is changed on the “Acquisition” panel of the “Acquire” tab if necessary.
- The default parameters use a Grad-90-Grad steady state between scans, which helps cleanup un-relaxed magnetization. This can result in much cleaner spectra, especially when using shorter acquisition times (at) and relaxation delays (d1) (defaults are 0.15s and 1s, respectively).
- A mixing time of 500ms is a good starting place for most small molecules. Very small molecules and/or weak NOE interactions may require longer mixing times (up to ~1s). Longer mixing times, however, increase the possibility of spin diffusion for larger molecules, a situation where the magnetization is transferred through space, and then through coupling, resulting in spurious correlations between protons. The NOE correlation can be confirmed by acquiring a build-up curve, whereby the mixing time is slowly increased in 50-100ms increments until the NOE intensity ceases to increase and levels off. This is the optimal mixing time.
- Medium-sized molecules (MW ~500 depending on the molecule and spectrometer frequency) can exhibit zero or very small NOEs. Consider acquiring a (HC)bsHSQCROESY for these molecules. Alternatively one may consider, (i) choosing a more viscous solvent such as d₆-DMSO or d₆-DMSO with ~10-20% D₂O (which results in slower molecular tumbling and hence generates a positive NOE enhancement like larger molecules), (ii) selecting a lower temperature (if the solvent allows it), or (iii) running the experiment on a spectrometer with higher field strength (if available).
- Small molecules may have crosspeaks arising from chemical exchange during the NOE mixing time and have the same phase as the diagonal. The exchange crosspeaks provide information about inter-converting molecular conformations and can be used to recognize such molecular dynamic processes.
- (HC)bsHSQCNOESY spectra may sometimes contain signals with partial antiphase character. Zero quantum suppression is embedded (and switched on by default) into the (HC)bsHSQCNOESY pulse sequence to suppress such artifacts.

References:

S. Macura, Y. Huang, D. Suter, R. R. Ernst, *J. Magn. Reson.* 43 (1981) 259-281. (NOESY)

E. Kupce, R. Freeman, *J. Magn. Reson. Ser. A* 117 (1995) 246-256. (Adiabatic Pulses)

C. Gaillet, C. Liguart, P. Deberie, J. M. Nuzillard, *J. Magn. Reson.* 139 (1999) 454-459. (Band Selective HSQC/HMBC)

M. J. Trippleton, J. Keeler, *Angew. Chem. Int. Ed.* 42 (2003) 3938-3941. (Zero Quantum Suppression)

(HC)bsHSQCROESY

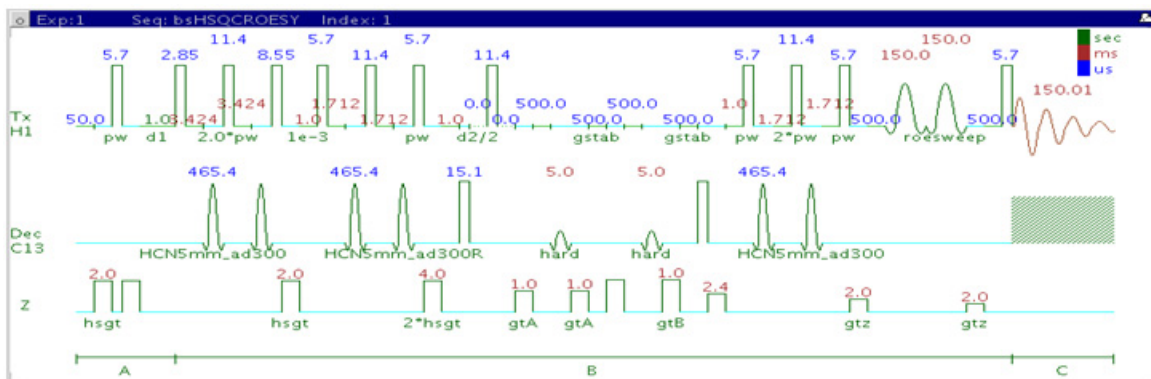

General description and usage

Description:

Two Dimensional heteronuclear single-quantum 1-bond J-correlation spectroscopy with the addition of a roesy mixing time Contains adiabatic 180° X-nuclei pulses and band-selection in F1.

Usage:

The (HC)bsHSQCROESY experiment is used to acquire a 2-dimensional spectrum to collect information correlating NOE and carbon chemical shift information, for example, Proton A has an ROE to proton B at carbon chemical shift X. The band-selection along F1 dimension gives the (HC)bsHSQCROESY an advantage of a better resolution than a non-selective HSQCROESY. The selected band can either be typed in or chosen interactively from a previously acquired HSQC-type spectrum. All parameters are set from the "Acquire" tab/"Defaults" panel unless otherwise specified.

Key parameters

Parameters	Description
Spectral Width (sw)	Set from previously acquired PROTON*
Acquisition time (at)	Set from "Pulse Sequence" panel, controls the resolution in F2, default 0.15s
F1 Nucleus (dn)	Pull- down menu to set F1 nucleus to ^{13}C , ^{15}N , or other*
C13 Spectral Width (ppm)	Type in desired chemical shift range for F1 dimension or check box to select interactively from previously acquired gHSQCAD
Scans per t1 increment (nt)	Select typical choices from pull down menu*
t1 Increments (ni)	Select typical choices from pull down menu*- controls the resolution in F1 (minimum ~64)
One-Bond J1xh (j1xh)	Set value for the average $^1J_{\text{X,H}}$ - 146 Hz works well for many carbons
Spinlock Duration	Select from pull down menu- 200ms works well for most small molecules* DO NOT EXCEED 500ms
Steady State (ss)	Set from second "Pulse Sequence" panel, turn on/off gradient cleanup between scans
C12-H1 suppression	Set from "Pulse Sequence" panel- controls type of ^{12}C suppression- default is TANGO-Gradient (highly recommended)

NOTE

You can type specific values for these parameters manually in the appropriate boxes on the "Acquisition" or "Pulse Sequence" panels.

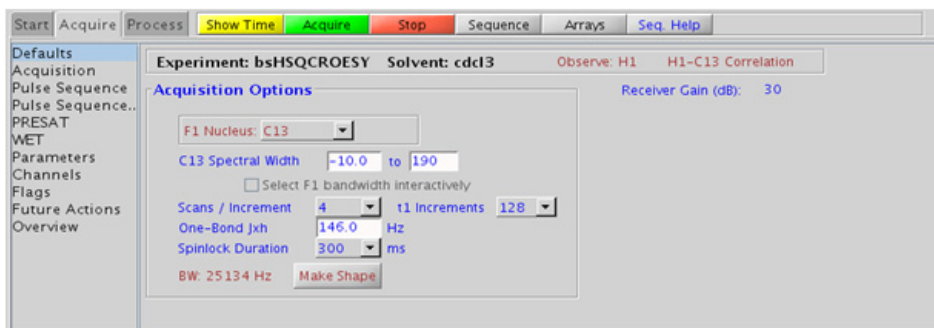

Processing

Automated processing is turned on by default, and the parameters are set to reasonable values, such that the resulting data after the acquisition usually require no further adjustment. The “Process” tab/“Basic” panel contains many of the commonly modified processing parameters, such as a pull-down menu to change the FT data size (1k x 1k is the default), as well as a check box to turn on/off linear prediction and a pull-down to control the extent of linear prediction (default is 4*ni). Menus to quickly change the weighting functions in F2/F1 are also present (defaults are gaussians); the parameters for the weighting functions are calculated automatically from the acquisition time and number of increments. More processing details are found under some of the other “Process” panels, such as the “Default”, “Weighting”, and “More 2D” panels.

Tips, tricks, and next steps

- Spectral width (sw) setting transfers from a PROTON if the (HC)bsHSQCROESY is set up from this experiment. All HSQC-related parameters transfer if the experiment is set up from a previously acquired HSQC-type experiment and the F1 band may be selected interactively. Receiver gain (gain) is usually set to a high value (≥ 30), unless the sample is extremely concentrated or ^{13}C -labelled.

- The default number of steady state scans (ss) that are acquired before data acquisition to establish sample equilibrium is 32, which works for most samples. However, higher power carbon decoupling may cause some perturbations that may necessitate more ss scans to reach equilibrium. This value is changed on the “Acquisition” panel of the “Acquire” tab if necessary.
- The default parameters use a Grad-90-Grad steady state between scans, which helps cleanup un-relaxed magnetization. This can result in much cleaner spectra, especially when using shorter acquisition times (at) and relaxation delays (d1) (defaults are 0.15s and 1s, respectively).
- A mixing time of 200ms is a good starting place for most small molecules. Very weak ROE interactions may require longer mixing times (up to ~500ms), but keep the mixing time shorter as longer spinlocks may result in sample heating. It is a good idea not to exceed a 500ms spinlock.
- Because the mixing time for the (HC)bsHSQCROESY is limited, weaker correlations may not be observable. (HC)bsHSQCROESY is the experiment of choice over (HC)bsHSQCNOESY for medium-sized molecules (MW ~800-1000 depending on the molecule and spectrometer frequency), as they can exhibit zero or very small NOEs. One may consider running (HC)bsHSQCNOESY experiments (which can be run with longer mixing times) by (i) choosing a more viscous solvent such as d₆-DMSO or d₆-DMSO with ~10-20% D₂O (which results in slower molecular tumbling and hence generates a positive NOE enhancement like larger molecules), (ii) selecting a lower temperature (if the solvent allows it), or (iii) running the experiment on a spectrometer with higher field strength (if available).
- Crosspeaks in the (HC)bsHSQCROESY spectrum that have the same phase as the diagonal may arise from chemical exchange during the ROE mixing time, or due to TOCSY-type correlations (couplings). The exchange crosspeaks provide information about inter-converting molecular conformations and can be used to recognize such molecular dynamic processes.

References:

- A. Bax, D. G. Davies, *J. Magn. Reson.* 63 (1985) 207-213. (ROESY)
- E. Kupce, R. Freeman, *J. Magn. Reson. Ser. A* 117 (1995) 246-256. (Adiabatic Pulses)

7 Selective 2D - Sel2D
Tips, tricks, and next steps

C. Gaillet, C. Liquart, P. Deberie, J. M. Nuzillard, J. Magn. Reson. 139 (1999) 454-459. (Band Selective HSQC/HMBC)

M. J. Trippleton, J. Keeler, Angew. Chem. Int. Ed. 42 (2003) 3938-3941. (Zero Quantum Suppression)

(HH)bsROESY

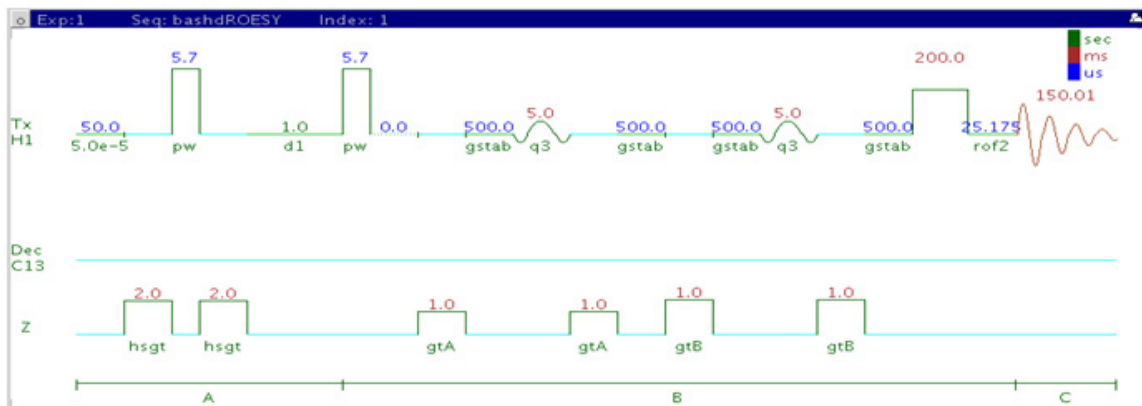

General description and usage

Description:

Two Dimensional through-space correlation spectroscopy in the rotating frame with band-selection in F1.

Usage:

This experiment produces a 2-dimensional spectrum with peaks along the diagonal corresponding to the peaks in a 1D PROTON and crosspeaks between protons that are close in space (typically $<4 \text{ \AA}$). This experiment has an added feature above the ROESY of band-selection in F1, which is an efficient way to increase the resolution in the F1 dimension without adding a large number of increments and, hence, experiment time. There is an added experimental option for homonuclear decoupling in F1 to further improve the resolution. The (HH)bsROESY can be very useful to obtain high-resolution through-space correlations to an overlapped area of the spectrum, for example the α -proton region of peptides. All parameters are set from the "Acquire" tab/"Defaults" panel unless otherwise specified.

Key parameters

Parameter	Description
Spectral Width (sw)	Set from previously acquired PROTON*
Acquisition time (at)	Set from "Pulse Sequence" panel, controls the resolution in F2, default 0.15s
Relaxation time (d1)	Set from "Acquisition" panel, controls the delay between scans
Number of scans (nt)	Select typical choices from pull down menu*
Spinlock Duration	Select from pull down menu- 200ms works well for most small molecules* DO NOT EXCEED 500ms
t1 Increments (ni)	Select typical choices from pull down menu*- controls the resolution in F1 (minimum ~64)
BB homodec during t1 (homodec)	Select yes/no for homonuclear decoupling in F1
Selection bandwidth	Set from previously acquired selexcit or type in specific values
Steady State (ss)	Set from "Pulse Sequence" panel, turn on/off gradient cleanup between scans

NOTE

You can type specific values for these parameters manually in the appropriate boxes on the "Acquisition" or "Pulse Sequence" panels.

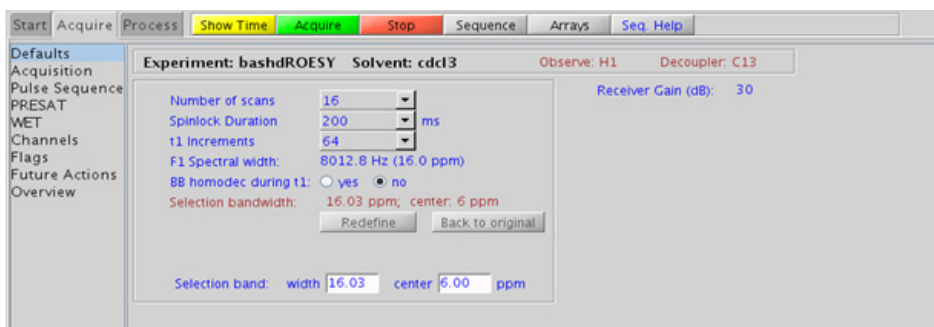

Processing

Automated processing is turned on by default, and the parameters are set to reasonable values, such that the resulting data after the acquisition usually require no further adjustment, except for minor manual phasing changes that may be required, as the ROE peaks are negative. The “Process” tab/“Basic” panel contains many of the commonly modified processing parameters, such as a pull-down menu to change the F₁ data size (1k x 1k is the default), as well as a check box to turn on/off linear prediction and a pull-down to control the extent of linear prediction (default is 2*ni). Menus to quickly change the weighting functions in F₂/F₁ are also present (defaults are gaussians); the parameters for the weighting functions are calculated automatically from the acquisition time and number of increments. More processing details are found under some of the other “Process” panels, such as the “Default”, “Weighting”, and “More 2D” panels.

Tips, tricks, and next steps

- Spectral width (sw) setting transfers from a PROTON if the (HH)bsROESY is set up from this experiment. The F₁ band is then selected interactively. Optimized selected bandwidth, sw, and receiver gain settings transfer from a selexcit if the (HH)bsROESY is set up from this experiment.
- The default number of “steady state” or “dummy scans” that are acquired before data acquisition to establish sample equilibrium is 32, which works for most samples. This value is changed on the “Acquisition” panel of the “Acquire” tab if necessary.
- The default parameters use a Grad-90-Grad steady state between scans, which helps cleanup un-relaxed magnetization. This can result in much cleaner spectra, especially when using shorter acquisition times and d1 relaxation delays (defaults are 0.15s and 1s, respectively).
- The homonuclear decoupling option (homodec) along F₁ necessitates that the selected resonances do not have mutual homonuclear coupling among themselves.

- A mixing time of 200ms is a good starting place for most small molecules. Very weak ROE interactions may require longer mixing times (up to ~500ms), but keep the mixing time shorter as longer spinlocks may result in sample heating. It is a good idea not to exceed a 500ms spinlock.
- Because the mixing time for the (HH)bsROESY is limited, weaker correlations may not be observable. (HH)bsROESY is the experiment of choice over (HH)bsNOESY for medium-sized molecules (MW ~800-1000 depending on the molecule and spectrometer frequency), as they can exhibit zero or very small NOEs. One may consider running (HH)bsNOESY experiments (which can be run with longer mixing times) by (i) choosing a more viscous solvent such as d₆-DMSO or d₆-DMSO with ~10-20% D₂O (which results in slower molecular tumbling and hence generates a positive NOE enhancement like larger molecules), (ii) selecting a lower temperature (if the solvent allows it), or (iii) running the experiment on a spectrometer with higher field strength (if available).
- Crosspeaks in the (HH)bsROESY spectrum that have the same phase as the diagonal may arise from chemical exchange during the ROE mixing time, or due to TOCSY-type correlations (couplings). The exchange crosspeaks provide information about inter-converting molecular conformations and can be used to recognize such molecular dynamic processes.

References:

- A. Bax, D. G. Davis, *J. Magn. Reson.* 63 (1985) 207-213. (ROESY)
- T. L. Hwang, A. J. Shaka, *J. Am. Chem. Soc.* 114 (1992) 3157-3159. (EASY-ROESY)
- A. Kaerner, D. L. Rabenstein, *Magn. Reson. Chem.* 36 (1998) 601-607. (Band Selective ROESY)

(HH)bsTOCSY

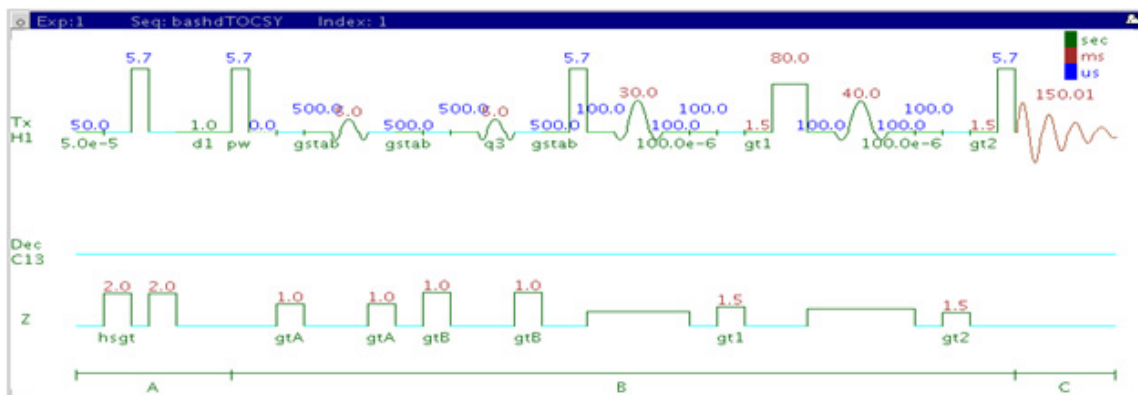

General description and usage

Description:

Two Dimensional total J-correlation spectroscopy for scalar coupled spin systems with a zero-quantum filter for artifact suppression and band-selection in F1.

Usage:

This experiment produces a 2-dimensional spectrum with peaks along the diagonal corresponding to the peaks in a 1D PROTON and crosspeaks between several protons in a scalar coupled spin system. This experiment has an added feature above the zTOCSY of band-selection in F1, which is an efficient way to increase the resolution in the F1 dimension without adding a large numbers of increments and, hence, experiment time. There is an added experimental option for homonuclear decoupling in F1 to further improve the resolution. The (HH)bsTOCSY can be very useful to obtain high-resolution through-bond correlations to a overlapped area of the spectrum, for example the a-proton region of peptides. All parameters are set from the “Acquire” tab/”Defaults” panel unless otherwise specified.

Key parameters

Parameter	Description
Spectral Width (sw)	Set from previously acquired PROTON*
Acquisition time (at)	Set from "Pulse Sequence" panel, controls the resolution in F2, default 0.15s
Relaxation time (d1)	Set from "Acquisition" panel, controls the delay between scans
Number of scans (nt)	Select typical choices from pull down menu*
Spinlock Duration (mixT)	Select from pull down menu- 80ms works best for large spin systems*
t1 Increments (ni)	Select typical choices from pull down menu*- controls the resolution in F1 (minimum ~64)
BB homodec during t1 (homodec)	Select yes/no for homonuclear decoupling in F1
Selection bandwidth	Set from previously acquired selexcit or type in specific values
Spinlock Pattern	Pull-down menu on the "Pulse Sequence" panel- dipsi2 or dipsi3
Steady State (ss)	Set from "Pulse Sequence" panel, turn on/off gradient cleanup between scans

NOTE

You can type specific values for these parameters manually in the appropriate boxes on the "Acquisition" or "Pulse Sequence" panels.

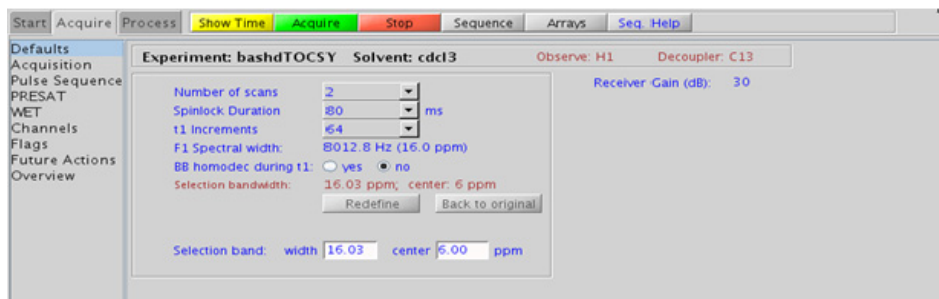

Processing

Automated processing is turned on by default, and the parameters are set to reasonable values, such that the resulting data after the acquisition usually require no further adjustment. The “Process” tab/“Basic” panel contains many of the commonly modified processing parameters, such as a pull-down menu to change the FT data size (1k x 1k is the default), as well as a check box to turn on/off linear prediction and a pull-down to control the extent of linear prediction (default is 2*ni). Menus to quickly change the weighting functions in F2/F1 are also present (defaults are gaussians); the parameters for the weighting functions are calculated automatically from the acquisition time and number of increments. More processing details are found under some of the other “Process” panels, such as the “Default”, “Weighting”, and “More 2D” panels.

Tips, tricks, and next steps

- Spectral width (sw) setting transfers from a PROTON if the (HH)bsTOCSY is set up from this experiment. The F1 band is then selected interactively. Optimized selected bandwidth, sw, and receiver gain settings transfer from a selexcit if the (HH)bsTOCSY is set up from this experiment.
- The default number of “steady state” or “dummy scans” that are acquired before data acquisition to establish sample equilibrium is 32, which works for most samples. This value is changed on the “Acquisition” panel of the “Acquire” tab if necessary.

- The homonuclear decoupling option (homodec) along F1 necessitates that the selected resonances do not have mutual homonuclear coupling among themselves.
- The spinlock time (in addition to the magnitude of the coupling constants) ultimately controls how far along the spin system the correlations extend. Use spinlock durations exceeding 150ms with caution, as this can result in sample heating. The efficiency of the TOCSY transfer is directly proportional to the size of the coupling constants between the pairs of protons. To show primarily vicinal and geminal couplings, select a shorter spinlock time, for example, 30ms or less.
- The DIPSI2 spinlock pattern is a good choice for small molecules and the DIPSI3 is typically used for larger molecules
- The default parameters use a Grad-90-Grad steady state between scans, which helps cleanup un-relaxed magnetization. This can result in much cleaner spectra, especially when using shorter acquisition times and d1 relaxation delays (defaults are 0.15s and 1s, respectively).
- The (HH)bsTOCSY experiment contains a zero-quantum filter, and usually results in cleaner spectra. The zero-quantum suppression filter is switched on by default.

References:

A. Bax, D. G. Davis, *J. Magn. Reson.* 63 (1985) 355-360. (TOCSY with MLEV17)

J. Cavanaugh, M. Rance, *J. Magn. Reson.* 96 (1992) 670-678. (TOCSY with DIPSI2)

V. V. Krishnamurthy, *Magn. Reson. Chem.* 35 (1997) 9-12. (Band Selective TOCSY)

M. J. Trippleton, J. Keeler, *Angew. Chem. Int. Ed.* 42 (2003) 3938-3941. (Zero Quantum Suppression)

(HH)bsNOESY

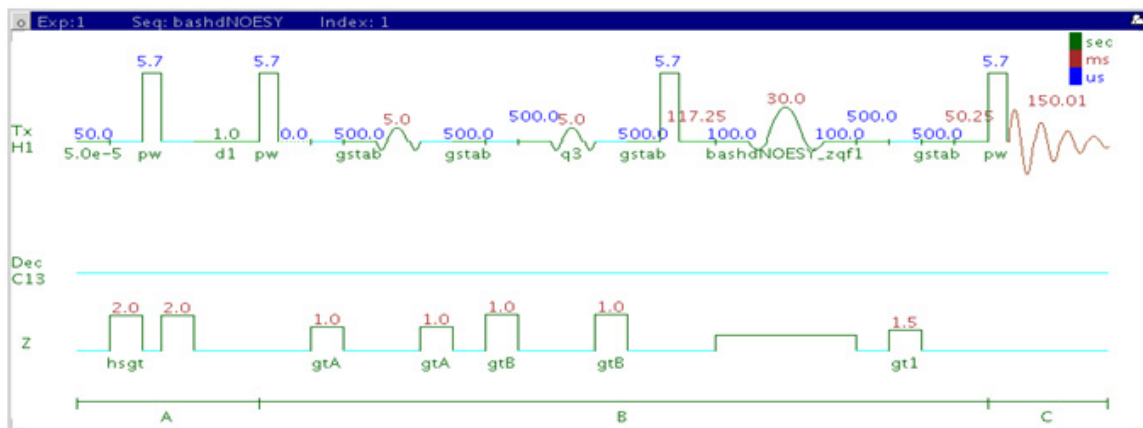

General description and usage

Description:

Two Dimensional through-space correlation spectroscopy with band-selection in F1.

Usage:

This experiment produces a 2-dimensional spectrum with peaks along the diagonal corresponding to the peaks in a 1D PROTON and crosspeaks between protons that are close in space (typically <4 Å). This experiment has an added feature above the NOESY of band-selection in F1, which is an efficient way to increase the resolution in the F1 dimension without adding a large number of increments and, hence, experiment time. There is an added experimental option for homonuclear decoupling in F1 to further improve the resolution. The (HH)bsNOESY can be very useful to obtain high-resolution through-space correlations to a overlapped area of the spectrum, for example the α-proton region of peptides. All parameters are set from the “Acquire” tab/”Defaults” panel unless otherwise specified.

Key parameters

Parameters	Description
Spectral Width (sw)	Set from previously acquired PROTON*
Acquisition time (at)	Set from "Pulse Sequence" panel, controls the resolution in F2, default 0.15s
Relaxation time (d1)	Set from "Acquisition" panel, controls the delay between scans
Number of scans (nt)	Select typical choices from pull down menu*
NOE Mixing time (mixN)	Select from pull down menu- 500ms works well as a starting point*
t1 Increments (ni)	Select typical choices from pull down menu*- controls the resolution in F1 (minimum ~64)
BB homodec during t1 (homodec)	Select yes/no for homonuclear decoupling in F1
Selection bandwidth	Set from previously acquired selexcit or type in specific values
Steady State (ss)	Set from "Pulse Sequence" panel, turn on/off gradient cleanup between scans

NOTE

You can type specific values for these parameters manually in the appropriate boxes on the "Acquisition" or "Pulse Sequence" panels.

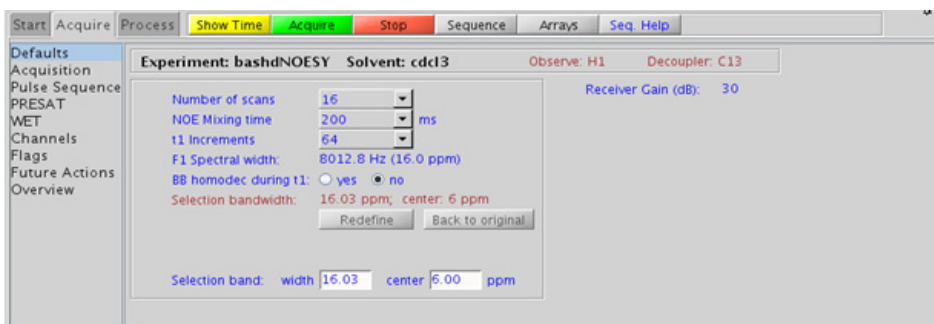

Processing

Automated processing is turned on by default, and the parameters are set to reasonable values, such that the resulting data after the acquisition usually require no further adjustment, except for minor manual phasing changes that may be required, as the NOE peaks are negative for smaller molecules. The “Process” tab/“Basic” panel contains many of the commonly modified processing parameters, such as a pull-down menu to change the FT data size (1k x 1k is the default), as well as a check box to turn on/off linear prediction and a pull-down to control the extent of linear prediction (default is 2*ni). Menus to quickly change the weighting functions in F2/F1 are also present (defaults are gaussians); the parameters for the weighting functions are calculated automatically from the acquisition time and number of increments. More processing details are found under some of the other “Process” panels, such as the “Default”, “Weighting”, and “More 2D” panels.

Tips, tricks, and next steps

- Spectral width (sw) setting transfers from a PROTON if the (HH)bsNOESY is set up from this experiment. The F1 band is then selected interactively. Optimized selected bandwidth, sw, and receiver gain settings transfer from a selexcit if the (HH)bsNOESY is set up from this experiment.
- The default number of “steady state” or “dummy scans” that are acquired before data acquisition to establish sample equilibrium is 32, which works for most samples. This value is changed on the “Acquisition” panel of the “Acquire” tab if necessary.
- The homonuclear decoupling option (homodec) along F1 necessitates that the selected resonances do not have mutual homonuclear coupling among themselves.
- The default parameters use a Grad-90-Grad steady state between scans, which helps cleanup un-relaxed magnetization. This can result in much cleaner spectra, especially when using shorter acquisition times and d1 relaxation delays (defaults are 0.15s and 1s, respectively).

- The default parameters use a Grad-90-Grad steady state between scans, which helps cleanup un-relaxed magnetization. This can result in much cleaner spectra, especially when using shorter acquisition times (at) and relaxation delays (d1) (defaults are 0.15s and 1s, respectively).
- A mixing time of 500ms is a good starting place for most small molecules. Very small molecules and/or weak NOE interactions may require longer mixing times (up to ~1s). Longer mixing times, however, increase the possibility of spin diffusion for larger molecules, a situation where the magnetization is transferred through space, and then through coupling, resulting in spurious correlations between protons. The NOE correlation can be confirmed by acquiring a build-up curve, whereby the mixing time is slowly increased in 50-100ms increments until the NOE intensity ceases to increase and levels off. This is the optimal mixing time.
- Medium-sized molecules (MW ~500 depending on the molecule and spectrometer frequency) can exhibit zero or very small NOEs. Consider acquiring a (HH)bsROESY for these molecules. Alternatively one may consider, (i) choosing a more viscous solvent such as d₆-DMSO or d₆-DMSO with ~10-20% D₂O (which results in slower molecular tumbling and hence generates a positive NOE enhancement like larger molecules), (ii) selecting a lower temperature (if the solvent allows it), or (iii) running the experiment on a spectrometer with higher field strength (if available).
- Small molecules may have crosspeaks arising from chemical exchange during the NOE mixing time and have the same phase as the diagonal. The exchange crosspeaks provide information about inter-converting molecular conformations and can be used to recognize such molecular dynamic processes.
- (HH)bsNOESY spectra may sometimes contain signals with partial antiphase character. Zero quantum suppression is embedded (and switched on by default) into the bsNOESY pulse sequence to suppress such artifacts.

References:

S. Macura, Y. Huang, D. Suter, R. R. Ernst, J. Magn. Reson. 43 (1981) 259-281. (NOESY)

K. Stott, J. Stonehouse, J. Keeler, T. L. Hwang, A. J. Shaka, J. Am. Chem. Soc. 117 (1995) 4199-4200. (Excitation Sculpting)

7 Selective 2D - Sel2D
Tips, tricks, and next steps

M. J. Trippleton, J. Keeler, *Angew. Chem. Int. Ed.* 42 (2003) 3938-3941.
(Zero Quantum Suppression)



8 Heteronuclear CRISIS2- (HC)Crisis2

(HC)Crisis2 Tab	294
c2hsqcse	296
c2hsqc	300
gc2h2bcme	304
gc2h2bc	308
gc2hmbcme	312
gc2hmbc	318
gc2hsqcse	322
gc2hsqc	326



(HC)Crisis2 Tab

The (HC)Crisis2 experiments are a suite of commonly-used heteronuclear 2D experiments that differ by having bip (broadband inversion pulse) pulses or adiabatic pulses in both the ^{13}C and ^1H channels. For all the experiments in this tab, you can use either bip or adiabatic inversion pulses in one or both channels by the appropriate selection of the bipflg parameter.

The bipflg parameter value typically has two characters. The first character represents channel 1 (^1H) and the 2nd character represents channel 2 (^{13}C). A value of “y” uses bip inversion pulse while a value of “n” uses adiabatic inversion pulses. The advantage of adiabatic pulses is that they are tunable to any specific bandwidth using Pbox utility while the bip pulse shapes are supplied for a given bandwidth and duration, Setup and use of all of these experiments is exactly the same as the corresponding experiments found in the J1(CH)corr (Chapter 4) and the Jn(CH)corr (Chapter 5) tabs.

These experiments can be particularly useful when acquiring a collection of samples in automation that may adversely and variably affect the probe tuning/calibrations because of variations in salt concentrations, different solvents, etc. The bip pulses can compensate for imperfect calibrations, resulting in good data quality under these difficult conditions. Crisis2 experiments, because of their broadband inversion pulses on both channels, are also the best choice for ¹⁹F-X correlation.

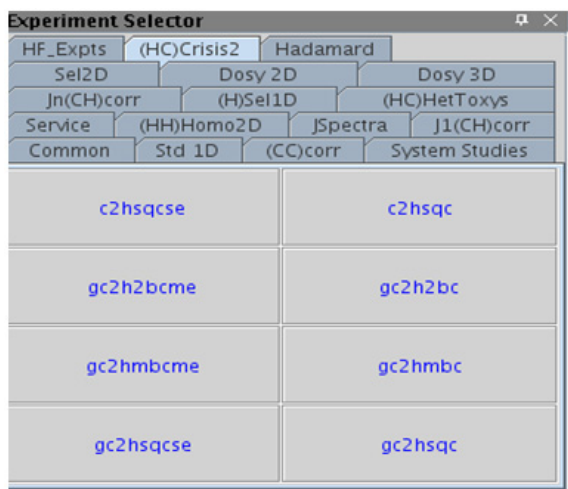

c2hsqcse

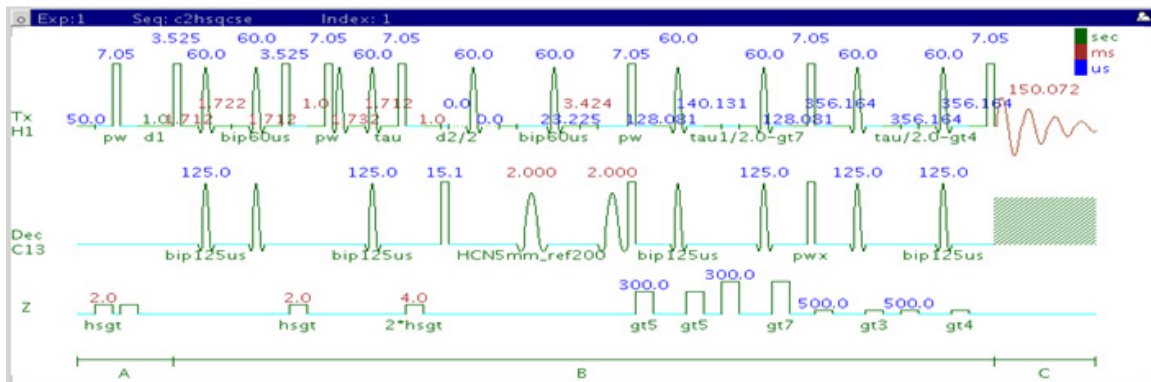

General description and usage

Description:

Two Dimensional heteronuclear single-quantum 1-bond J-correlation spectroscopy with bip and/or adiabatic 180° pulses and sensitivity enhancement.

Usage:

The c2hsqcse experiment is used to acquire a 2-dimensional spectrum to correlate protons with directly attached carbons. The CRISIS2 (c2) version of this experiment uses either bip or adiabatic 180° pulses in both channels. The experiment is very useful for proton and carbon assignments, because if the proton assignment is known, the carbon assignment can be deduced directly from this data and vice versa. For structure elucidation, carbon chemical shifts are particularly useful as they are highly sensitive to local functional groups and can be more reliably predicted. All parameters are set from the “Acquire” tab/“Defaults” panel unless otherwise specified.

Key parameters

Parameter	Description
Spectral Width (sw)	Set from previously acquired PROTON*
Acquisition time (at)	Set from "Pulse Sequence" panel, controls the resolution in F2, default 0.15s
F1 Nucleus (dn)	Pull- down menu to set F1 nucleus to ^{13}C , ^{15}N , or other*
C13 Spectral Width (ppm)	Type in desired chemical shift range for F1 dimension
Scans per t1 increment (nt)	Select typical choices from pull down menu*
t1 Increments (ni)	Select typical choices from pull down menu*- controls the resolution in F1 (minimum ~64)
One-Bond J1xh (j1xh)	Set value for the average $^1J_{\text{X,H}}$ - 146 Hz works well for many carbons
H1-C13 Multiplicity Editing	Check box to turn on/off multiplicity editing
Steady State (ss)	Set from "Pulse Sequence" panel, turn on/off gradient cleanup between scans
C12-H1 suppression	Set from "Pulse Sequence" panel- controls type of ^{12}C suppression- default is TANGO-Gradient (highly recommended)

NOTE

Specific values for these parameters may be typed manually in the appropriate boxes on the "Acquisition" or "Pulse Sequence" panels.

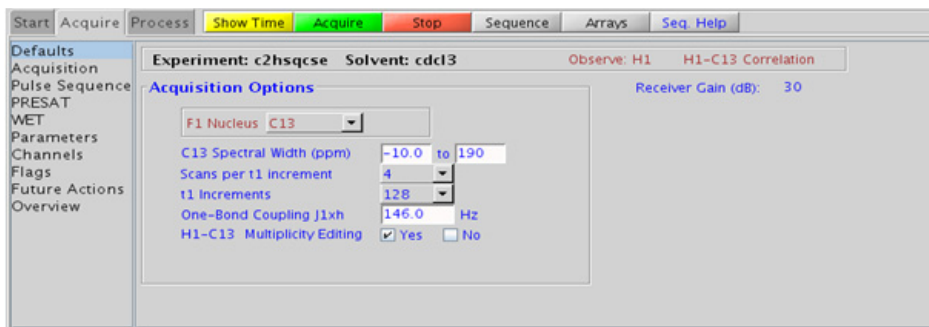

Processing

Automated processing is turned on by default, and the parameters are set to reasonable values, such that the resulting data after the acquisition usually require no further adjustment. The “Process” tab/“Basic” panel contains many of the commonly modified processing parameters, such as a pull-down menu to change the FT data size (1k x 1k is the default), as well as a check box to turn on/off linear prediction and a pull-down to control the extent of linear prediction (default is 4*ni). Menus to quickly change the weighting functions in F2/F1 are also present (defaults are gaussians); the parameters for the weighting functions are calculated automatically from the acquisition time and number of increments. More processing details are found under some of the other “Process” panels, such as the “Default”, “Weighting”, and “More 2D” panels.

Tips, tricks, and next steps

- Spectral width (sw) setting transfers from a PROTON if the c2hsqcse is set up from this experiment. Receiver gain (gain) is usually set to a high value (?30), unless the sample is extremely concentrated or ¹³C-labelled.
- To measure ¹H-¹³C (or ¹H-X) coupling constants, the carbon decoupling can be turned off by entering “nnn” in the Channel 2 “Dec On/Off” entry on the “Channels” panel or alternatively by typing dm='nnn' on the command line.

- The default number of steady state scans (ss) that are acquired before data acquisition to establish sample equilibrium is 32, which works for most samples. However, higher power carbon decoupling may cause some perturbations that may necessitate more ss scans to reach equilibrium. This value is changed on the “Acquisition” panel of the “Acquire” tab if necessary.
- The default parameters use a Grad-90-Grad steady state between scans, which helps cleanup un-relaxed magnetization. This can result in much cleaner spectra, especially when using shorter acquisition times (at) and relaxation delays (d1) (defaults are 0.15s and 1s, respectively).
- Using the multiplicity editing feature results in a spectrum with the peaks from methylene-type carbons having the opposite phase to methyl and methine-type carbons. The experiment uses the CRISIS technique to minimize sensitivity loss due to unmatched coupling constants and echo time. CRISIS based multiplicity editing is on by default.
- The c2hsqcse experiment has comparable sensitivity to the gc2hsqcse, but due to t1 noise from strong signals such as t-butyl, may produce potentially less clean spectra than its gradient counterpart.
- The c2hsqcse uses adiabatic or bip 180o carbon and proton pulses for much improved uniform inversion as well as for tolerance to RF inhomogeneity and/or pulse calibration imperfection.
- The c2hsqcse has a sensitivity enhancement feature which, in theory, can result in an increase of approximately a factor of 1-1.4 in sensitivity over c2hsqc.
- Datasets with moderate S/N are better processed with 2*ni linear prediction instead of the default (4*ni). Remember to reset the window function along F1 axis if linear prediction parameters are changed.

References:

R. D. Boyer, R. Johnson, K. Krishnamurthy, J. Magn. Reson. 165 (2003) 253-259 (gHSQCAD / CRISIS-gHSQC)

H. Hu, K. Krishnamurthy, Magn. Reson. Chem. 46 (2008) 683-689. (CRISIS2 with Multiplicity Editing)

c2hsqc

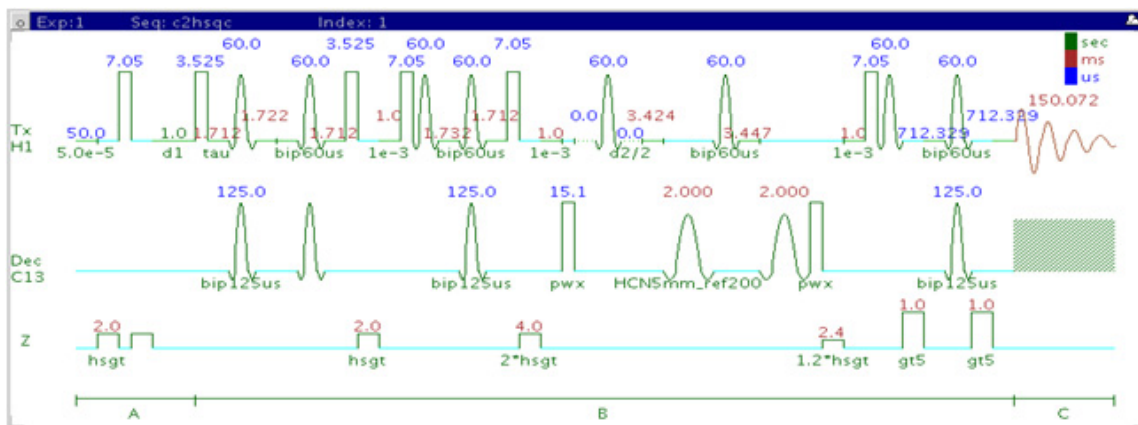

General description and usage

Description:

Two Dimensional heteronuclear single-quantum 1-bond J-correlation spectroscopy with bip and/or adiabatic 180° pulses.

Usage:

The c2hsqc experiment is used to acquire a 2-dimensional spectrum to correlate protons with directly attached carbons. The CRISIS2 (c2) version of this experiment uses either bip or adiabatic 180° pulses in both channels. The experiment is very useful for proton and carbon assignments, because if the proton assignment is known, the carbon assignment can be deduced directly from this data and vice versa. For structure elucidation, carbon chemical shifts are particularly useful as they are highly sensitive to local functional groups and can be more reliably predicted. All parameters are set from the “Acquire” tab/“Defaults” panel unless otherwise specified.

Key parameters

Parameters	Description
Spectral Width (sw)	Set from previously acquired PROTON*
Acquisition time (at)	Set from "Pulse Sequence" panel, controls the resolution in F2, default 0.15s
F1 Nucleus (dn)	Pull- down menu to set F1 nucleus to ^{13}C , ^{15}N , or other*
C13 Spectral Width (ppm)	Type in desired chemical shift range for F1 dimension
Scans per t1 increment (nt)	Select typical choices from pull down menu*
t1 Increments (ni)	Select typical choices from pull down menu*- controls the resolution in F1 (minimum ~64)
One-Bond J1xh (j1xh)	Set value for the average $^1J_{\text{X,H}}$ - 146 Hz works well for many carbons
H1-C13 Multiplicity Editing	Check box to turn on/off multiplicity editing
Steady State (ss)	Set from "Pulse Sequence" panel, turn on/off gradient cleanup between scans
C12-H1 suppression	Set from "Pulse Sequence" panel- controls type of ^{12}C suppression- default is TANGO-Gradient (highly recommended)

NOTE

Specific values for these parameters may be typed manually in the appropriate boxes on the "Acquisition" or "Pulse Sequence" panels.

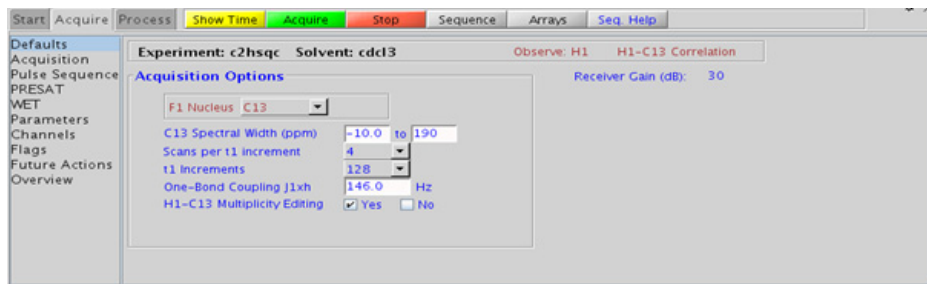

Processing

Automated processing is turned on by default, and the parameters are set to reasonable values, such that the resulting data after the acquisition usually require no further adjustment. The “Process” tab/“Basic” panel contains many of the commonly modified processing parameters, such as a pull-down menu to change the FT data size (1k x 1k is the default), as well as a check box to turn on/off linear prediction and a pull-down to control the extent of linear prediction (default is 4*ni). Menus to quickly change the weighting functions in F2/F1 are also present (defaults are gaussians); the parameters for the weighting functions are calculated automatically from the acquisition time and number of increments. More processing details are found under some of the other “Process” panels, such as the “Default”, “Weighting”, and “More 2D” panels.

Tips, tricks, and next steps

- Spectral width (sw) setting transfers from a PROTON if the c2hsqc is set up from this experiment. Receiver gain (gain) is usually set to a high value (?30), unless the sample is extremely concentrated or ¹³C-labelled.
- To measure ¹H-¹³C (or ¹H-X) coupling constants, the carbon decoupling can be turned off by entering “nnn” in the Channel 2 “Dec On/Off” entry on the “Channels” panel or alternatively by typing dm='nnn' on the command line.
- The default number of steady state scans (ss) that are acquired before data acquisition to establish sample equilibrium is 32, which works for most samples. However, higher power carbon decoupling may cause some perturbations that may necessitate more ss scans to reach equilibrium. This value is changed on the “Acquisition” panel of the “Acquire” tab if necessary.
- The default parameters use a Grad-90-Grad steady state between scans, which helps cleanup un-relaxed magnetization. This can result in much cleaner spectra, especially when using shorter acquisition times (at) and relaxation delays (d1) (defaults are 0.15s and 1s, respectively).

- Using the multiplicity editing feature results in a spectrum with the peaks from methylene-type carbons having the opposite phase to methyl and methine-type carbons. The experiment uses the CRISIS technique to minimize sensitivity loss due to unmatched coupling constants and echo time. CRISIS based multiplicity editing is on by default.
- The c2hsqc experiment has a sensitivity advantage (factor of ~ 1.4) over the gc2hsqc, but due to t1 noise from strong signals such as t-butyl, may produce potentially less clean spectra than its gradient counterpart.
- The c2hsqc uses adiabatic or bip 180° carbon and proton pulses for much improved uniform inversion as well as for tolerance to RF inhomogeneity and/or pulse calibration imperfection.
- Datasets with moderate S/N are better processed with 2*ni linear prediction instead of the default (4*ni). Remember to reset the window function along F1 axis if linear prediction parameters are changed.

References:

R. D. Boyer, R. Johnson, K. Krishnamurthy, J. Magn. Reson. 165 (2003) 253-259 (gHSQCAD / CRISIS-gHSQC)

H. Hu, K. Krishnamurthy, Magn. Reson. Chem. 46 (2008) 683-689. (CRISIS2 with Multiplicity Editing)

gc2h2bcme

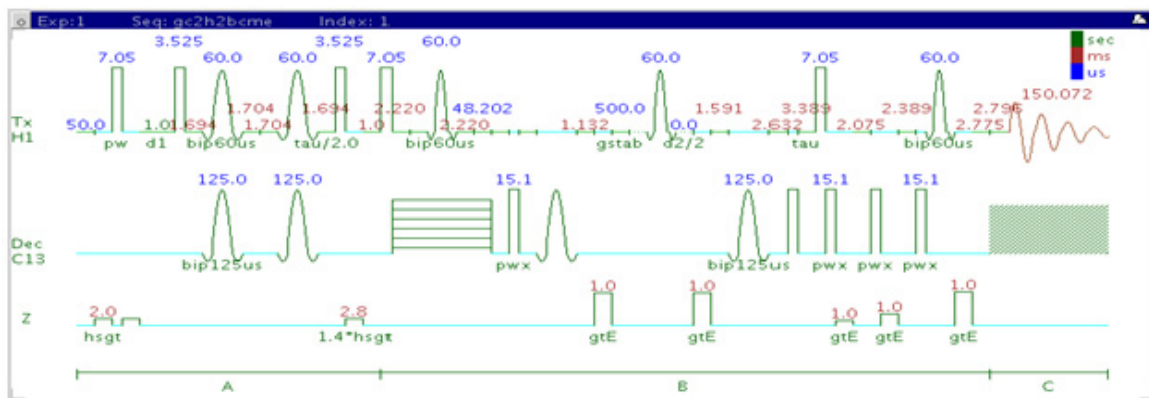

General description and usage

Description:

Two Dimensional heteronuclear 2-bond J-correlation spectroscopy with bip and/or adiabatic 180° pulses, gradient coherence selection, and multiplicity editing.

Usage:

The gc2h2bcme experiment is used to acquire a 2-dimensional spectrum to correlate protons to carbons over 2 bonds. The CRISIS2 (c2) version of this experiment uses either bip or adiabatic 180° pulses in both channels. Although the gc2h2bcme is less sensitive than the gc2hmbcme, this experiment is useful as supplemental information to distinguish between 2- and 3-bond correlations. This is an edited experiment acquired as an array of 2 spectra and needs to be processed in two different ways to generate the edited 2D spectra. Note that the experiment is constant time in F1, so the constant time delay (BigT) determines the maximum number of increments (ni). All parameters are set from the “Acquire” tab/”Defaults” panel unless otherwise specified.

Key parameters

Parameter	Description
Spectral Width (sw)	Set from previously acquired PROTON*
Acquisition time (at)	Set from "Pulse Sequence" panel, controls the resolution in F2, default 0.15s
F1 Nucleus (dn)	Pull- down menu to set F1 nucleus to ^{13}C , ^{15}N , or other*
C13 Spectral Width (ppm)	Type in desired chemical shift range for F1 dimension
Scans per t1 increment (nt)	Select typical choices from pull down menu*
t1 Increments (ni)	Type in value- controls the resolution in F1 (note maximum allowed from the constant time delay (BigT))
Multiple-Bond Jnxx (jnxx)	Pull-down menu to set value for the average $^n\text{J}_{\text{X,H}}$ - 8 Hz works well for most molecules
Constant Time (BigT)	Type in value on the "Pulse Sequence" panel for constant time delay- 0.022ms (default) works for most samples
Steady State (ss)	Set from "Pulse Sequence" panel, turn on/off gradient cleanup between scans
C12-H1 suppression	Set from "Pulse Sequence" panel- turn on/off TANGO-gradient suppression- default is on

NOTE

Specific values for these parameters may be typed manually in the appropriate boxes on the "Acquisition" or "Pulse Sequence" panels.

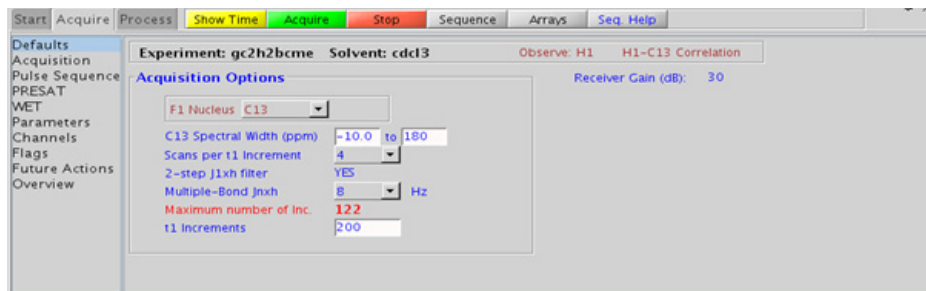

Processing

This is an edited experiment acquired as an array of 2 spectra and needs to be processed in two different ways to generate the edited 2D spectra. The “Process” tab/“Default” panel has three buttons under the “Transform” heading to select the desired subspectrum. The “Process” tab/“Basic” panel contains many of the commonly modified processing parameters, such as a pull-down menu to change the FT data size (2k x 1k is the default), as well as a check box to turn on/off linear prediction and a pull-down to control the extent of linear prediction (default is 4*ni). Menus to quickly change the weighting functions in F2/F1 are also present; the parameters for the weighting functions are calculated automatically from the acquisition time and number of increments. More processing details are found under some of the other “Process” panels, such as the “Default”, “Weighting”, and “More 2D” panels.

Tips, tricks, and next steps

- Spectral width (sw) setting transfers from a PROTON if the gc2h2bcme is set up from this experiment. Receiver gain (gain) is usually set to a high value (?30), unless the sample is extremely concentrated or ¹³C-labelled.
- The default number of steady state scans (ss) that are acquired before data acquisition to establish sample equilibrium is 32, which works for most samples. This value is changed on the “Acquisition” panel of the “Acquire” tab if necessary.
- The default parameters use a Grad-90-Grad steady state between scans, which helps cleanup un-relaxed magnetization. This can result in much cleaner spectra, especially when using shorter acquisition times (at) and relaxation delays (d1) (defaults are 0.15s and 1s, respectively).
- The gc2h2bcme is in principle a gHMQC-COSY type experiment. By this very nature, it can only show 2-bond correlations to protonated carbons but not for quaternary carbons. A 22ms bigT delay is an optimal value for COSY magnetization transfer.
- The gc2h2bcme experiment is specialized to show only 2-bond correlations, but it is less sensitive than the gc2hmbcme experiment. As such, the gc2h2bcme is best used as supplemental information to the gc2hmbcme data to distinguish between 2- and 3-bond correlations.

- The multiplicity-editing feature uses the CRISIS technique that relies on a hypothetical relationship between one-bond coupling constants and carbon chemical shifts. Carbons with coupling constants that deviate significantly from this relationship result in imperfect editing.
- As the gc2h2bcme is acquired as an array of two spectra, it takes twice as long to acquire and there is a small sensitivity loss with the multiplicity-editing.
- The gc2h2bcme uses adiabatic or bip 180° carbon and proton pulses for much improved uniform inversion as well as for tolerance to RF inhomogeneity and/or pulse calibration imperfection

References:

A. J. Benie, O. W. Sorensen, *Magn. Reson. Chem.* 44 (2006) 739-743.
(Multiplicity Edited HMBC)

N. T. Nyberg, J. O. Duus, O. W. Sorensen, *J. Am. Chem. Soc.* 127 (2007)
6154-6155. (H2BC)

H. Hu, K. Krishnamurthy, *Magn. Reson. Chem.* 46 (2008) 683-689. (CRISIS2
with Multiplicity Editing)

gc2h2bc

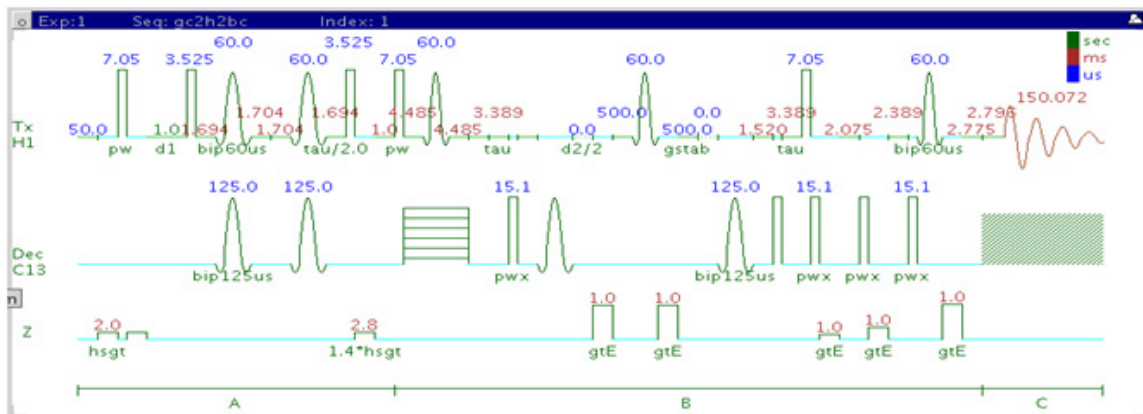

General description and usage

Description:

Two Dimensional heteronuclear 2-bond J-correlation spectroscopy with bip and/or adiabatic 180° pulses and gradient coherence selection.

Usage:

The gH2BCAD experiment is used to acquire a 2-dimensional spectrum to correlate protons to carbons over 2 bonds. The CRISIS2 (c2) version of this experiment uses either bip or adiabatic 180° pulses in both channels. Although the gc2h2bcme is less sensitive than the gc2hmbcme, this experiment is useful as supplemental information to distinguish between 2- and 3-bond correlations. Note that the experiment is constant time in F1, so the constant time delay (BigT) determines the maximum number of increments (ni). All parameters are set from the “Acquire” tab/”Defaults” panel unless otherwise specified.

Key parameters

Parameter	Description
Spectral Width (sw)	Set from previously acquired PROTON*
Acquisition time (at)	Set from "Pulse Sequence" panel, controls the resolution in F2, default 0.15s
F1 Nucleus (dn)	Pull- down menu to set F1 nucleus to ^{13}C , ^{15}N , or other*
C13 Spectral Width (ppm)	Type in desired chemical shift range for F1 dimension
Scans per t1 increment (nt)	Select typical choices from pull down menu*
t1 Increments (ni)	Type in value- controls the resolution in F1 (note maximum allowed from the constant time delay (BigT))
Multiple-Bond Jnxx (jnxx)	Pull-down menu to set value for the average $^n\text{J}_{\text{X,H}}$ - 8 Hz works well for most molecules
Constant Time (BigT)	Type in value on the "Pulse Sequence" panel for constant time delay- 0.022ms (default) works for most samples
Steady State (ss)	Set from "Pulse Sequence" panel, turn on/off gradient cleanup between scans
C12-H1 suppression	Set from "Pulse Sequence" panel- turn on/off TANGO-gradient suppression- default is on

NOTE

Specific values for these parameters may be typed manually in the appropriate boxes on the "Acquisition" or "Pulse Sequence" panels.



Processing

Automated processing is turned on by default, and the parameters are set to reasonable values, such that the resulting data after the acquisition usually require no further adjustment. The “Process” tab/“Basic” panel contains many of the commonly modified processing parameters, such as a pull-down menu to change the FT data size (2k x 1k is the default), as well as a check box to turn on/off linear prediction and a pull-down to control the extent of linear prediction (default is 4*ni). Menus to quickly change the weighting functions in F2/F1 are also present; the parameters for the weighting functions are calculated automatically from the acquisition time and number of increments. More processing details are found under some of the other “Process” panels, such as the “Default”, “Weighting”, and “More 2D” panels.

Tips, tricks, and next steps

- Spectral width (sw) setting transfers from a PROTON if the gc2h2bc is set up from this experiment. Receiver gain (gain) is usually set to a high value (≥ 30), unless the sample is extremely concentrated or ^{13}C -labelled.
- The default number of steady state scans (ss) that are acquired before data acquisition to establish sample equilibrium is 32, which works for most samples. This value is changed on the “Acquisition” panel of the “Acquire” tab if necessary.
- The default parameters use a Grad-90-Grad steady state between scans, which helps cleanup un-relaxed magnetization. This can result in much cleaner spectra, especially when using shorter acquisition times (at) and relaxation delays (d1) (defaults are 0.15s and 1s, respectively).
- The gc2h2bc is in principle a gHMQC-COSY type experiment. By this very nature, it can only show 2-bond correlations to protonated carbons but not for quaternary carbons. A 22ms bigT delay is an optimal value for COSY magnetization transfer.
- The gc2h2bc experiment is specialized to show only 2-bond correlations, but it is less sensitive than the gc2hmbc experiment. As such, the gc2h2bc is best used as supplemental information to the gc2hmbc data to distinguish between 2- and 3-bond correlations.

- The gc2h2bc uses adiabatic or bip 180° carbon and proton pulses for much improved uniform inversion as well as for tolerance to RF inhomogeneity and/or pulse calibration imperfection.

References:

- N. T. Nyberg, J. O. Duus, O. W. Sorensen, J. Am. Chem. Soc. 127 (2007) 6154-6155. (H2BC)
- R. E. Hurd, J. Magn. Reson. 87 (1990) 422-428. (Gradient based Coherence Selection)
- E. Kupce, R. Freeman, J. Magn. Reson. Ser. A 117 (1995) 246-256. (Adiabatic Pulses)
- H. Hu, K. Krishnamurthy, Magn. Reson. Chem. 46 (2008) 683-689. (CRISIS2 with Multiplicity Editing)

gc2hmbcme

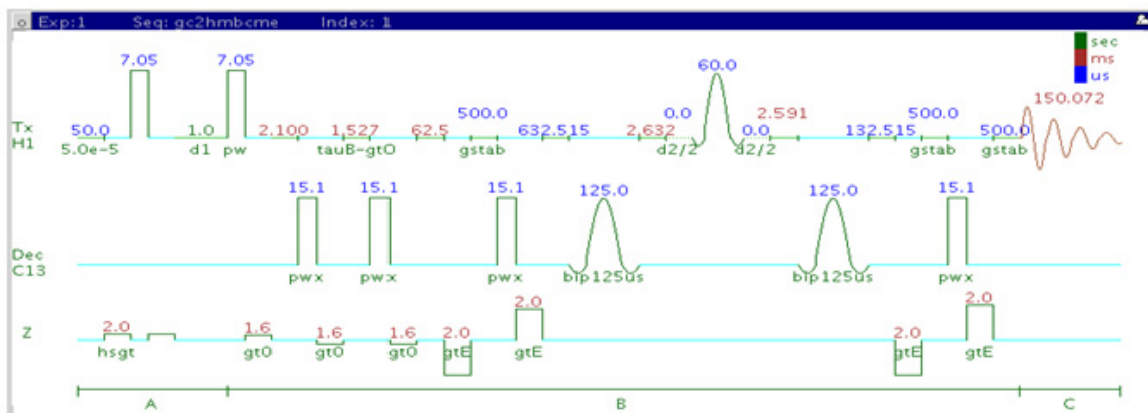

General description and usage

Description:

Two Dimensional heteronuclear multiple-bond J-correlation spectroscopy with bip and/or adiabatic 180° pulses, gradient coherence selection, and multiplicity editing.

Usage:

The gc2hmbcme experiment is used to acquire a 2-dimensional spectrum to correlate protons to carbons, usually over 2-3 bonds with the 3-bond correlations typically being stronger. The CRISIS2 (c2) version of this experiment uses either bip or adiabatic 180° pulses in both channels. The experiment is highly useful for structure elucidation as the longer range correlations allow connectivities between isolated proton spin systems to be identified. This is an edited experiment acquired as an array of 2 spectra and needs to be processed in two different ways to generate the edited 2D spectra. For structure elucidation, carbon chemical shifts are

particularly useful as they are highly sensitive to local functional groups and can be reliably predicted with software. All parameters are set from the “Acquire” tab/”Defaults” panel unless otherwise specified.

Key parameters

Parameter	Description
Spectral Width (sw)	Set from previously acquired PROTON*
Acquisition time (at)	Set from “Pulse Sequence” panel, controls the resolution in F2, default 0.15s
F1 Nucleus (dn)	Pull- down menu to set F1 nucleus to ^{13}C , ^{15}N , or other*
C13 Spectral Width (ppm)	Type in desired chemical shift range for F1 dimension
Scans per t1 increment (nt)	Select typical choices from pull down menu*
t1 Increments (ni)	Select typical choices from pull down menu*- controls the resolution in F1 (minimum ~64)
Multiple-Bond JnXH (jnxh)	Pull-down menu to set value for the average $^n\text{J}_{\text{X,H}}$. 8 Hz works well for most molecules
One-Bond suppression	Set from “Pulse Sequence” panel- turn on/off suppression of one-bond correlations- default is on
Steady State (ss)	Set from “Pulse Sequence” panel, turn on/off gradient cleanup between scans

NOTE

Specific values for these parameters may be typed manually in the appropriate boxes on the “Acquisition” or “Pulse Sequence” panels.

8 Heteronuclear CRISIS2- (HC)Crisis2 Processing

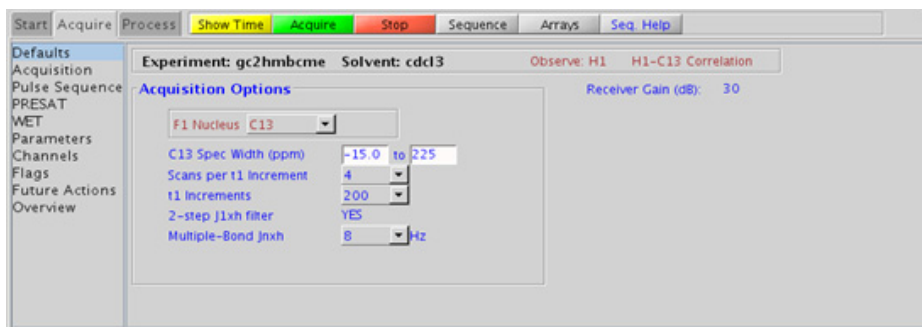

Processing

This is an edited experiment acquired as an array of 2 spectra and needs to be processed in two different ways to generate the edited 2D spectra. The “Process” tab/“Default” panel has three buttons under the “Transform” heading to select the desired subspectrum. The “Process” tab/“Basic” panel contains many of the commonly modified processing parameters, such as a pull-down menu to change the FT data size (2k x 1k is the default), as well as a check box to turn on/off linear prediction and a pull-down to control the extent of linear prediction (default is 4*ni). Menus to quickly change the weighting functions in F2/F1 are also present (defaults are gaussian in F1 and sqsinebell in F2); the parameters for the weighting functions are calculated automatically from the acquisition time and number of increments. More processing details are found under some of the other “Process” panels, such as the “Default”, “Weighting”, and “More 2D” panels. It is important to note that this experiment employs mix-mode processing, with the F2 dimension absolute value and F1 phase-sensitive. This arrangement allows for the best resolution and sensitivity combination.

Tips, tricks, and next steps

- Spectral width (sw) setting transfers from a PROTON if the gc2hmbcme is set up from this experiment. Receiver gain (gain) is usually set to a high value (?30), unless the sample is extremely concentrated or ¹³C-labelled.
- The default number of steady state scans (ss) that are acquired before data acquisition to establish sample equilibrium is 32, which works for most samples. This value is changed on the “Acquisition” panel of the “Acquire” tab if necessary.
- The default parameters use a Grad-90-Grad steady state between scans, which helps cleanup un-relaxed magnetization. This can result in much cleaner spectra, especially when using shorter acquisition times (at) and relaxation delays (d1) (defaults are 0.15s and 1s, respectively).
- The multiplicity-editing feature uses the CRISIS technique that relies on a hypothetical relationship between one-bond coupling constants and carbon chemical shifts. Carbons with coupling constants that deviate significantly from this relationship result in imperfect editing.
- As the gHMBcmeAD is acquired as an array of two spectra, it takes twice as long to acquire and there is a small sensitivity loss with the multiplicity-editing.
- The experiment features a 2-step low-pass filter that can eliminate undesired crosspeaks from one-bond couplings. Select two coupling constants on the “Pulse Sequence” panel around which one-bond couplings are eliminated (default values are 165 and 130 Hz). These filters are rather narrow-band, however, and if the spread of coupling constants is such that some couplings lie considerably outside these values (for example 115 or 145 Hz), its signals may still be visible in the spectrum. As HMBC-type spectra are recorded without ¹³C decoupling, such signals can usually still be discerned from long-range crosspeaks by their one-bond splitting.
- The gc2hmbcme uses adiabatic or bip 180° carbon and proton pulses for much improved uniform inversion as well as for tolerance to RF inhomogeneity and/or pulse calibration imperfection.

References:

A. J. Benie, O. W. Sorensen, Magn. Reson. Chem. 44 (2006) 739-743.
(Multiplicity Edited HMBC)

8 Heteronuclear CRISIS2- (HC)Crisis2

Tips, tricks, and next steps

H. Hu, K. Krishnamurthy, *Magn. Reson. Chem.* 46 (2008) 683-689. (CRISIS2 with Multiplicity Editing)

gc2hmbc

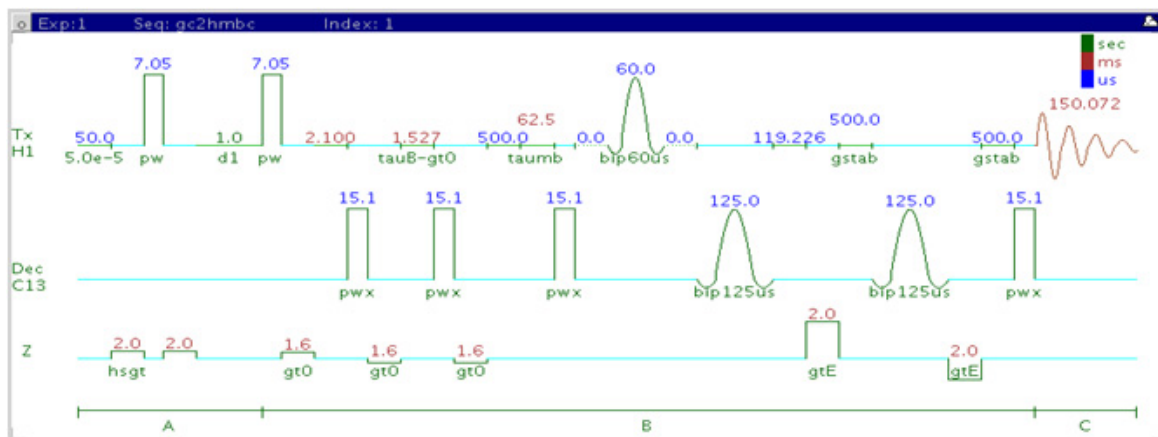

General description and usage

Description:

Two Dimensional heteronuclear multiple-bond J-correlation spectroscopy with bip and/or adiabatic 180° pulses and gradient coherence selection.

Usage:

The gc2hmbc experiment is used to acquire a 2-dimensional spectrum to correlate protons to carbons, usually over 2-3 bonds with the 3-bond correlations typically being stronger. The CRISIS2 (c2) version of this experiment uses either bip or adiabatic 180° pulses in both channels. The experiment is highly useful for structure elucidation as the longer range correlations allow connectivities between isolated proton spin systems to be identified. For structure elucidation, carbon chemical shifts are particularly useful as they are highly sensitive to local functional groups and can be reliably predicted with software. All parameters are set from the "Acquire" tab/"Defaults" panel unless otherwise specified.

Key parameters

Parameters	Description
Spectral Width (sw)	Set from previously acquired PROTON*
Acquisition time (at)	Set from "Pulse Sequence" panel, controls the resolution in F2, default 0.15s
F1 Nucleus (dn)	Pull- down menu to set F1 nucleus to ^{13}C , ^{15}N , or other*
C13 Spectral Width (ppm)	Type in desired chemical shift range for F1 dimension
Scans per t1 increment (nt)	Select typical choices from pull down menu*
t1 Increments (ni)	Select typical choices from pull down menu*- controls the resolution in F1 (minimum ~64)
Multiple-Bond Jnxx (jnxx)	Pull-down menu to set value for the average $^n\text{J}_{\text{X,H}}$ - 8 Hz works well for most molecules
One-Bond suppression	Set from "Pulse Sequence" panel- turn on/off suppression of one-bond correlations- default is on
Steady State (ss)	Set from "Pulse Sequence" panel, turn on/off gradient cleanup between scans

NOTE

Specific values for these parameters may be typed manually in the appropriate boxes on the "Acquisition" or "Pulse Sequence" panels.

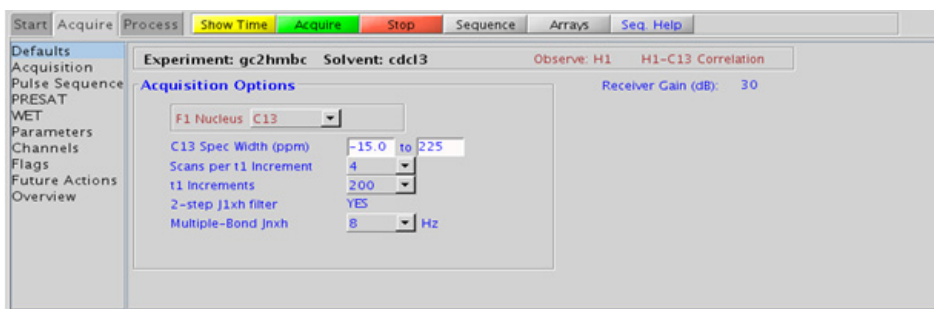

Processing

Automated processing is turned on by default, and the parameters are set to reasonable values, such that the resulting data after the acquisition usually require no further adjustment. The “Process” tab/“Basic” panel contains many of the commonly modified processing parameters, such as a pull-down menu to change the FT data size (2k x 1k is the default), as well as a check box to turn on/off linear prediction and a pull-down to control the extent of linear prediction (default is 4*ni). Menus to quickly change the weighting functions in F2/F1 are also present (defaults are gaussian in F1 and sqsinebell in F2); the parameters for the weighting functions are calculated automatically from the acquisition time and number of increments. More processing details are found under some of the other “Process” panels, such as the “Default”, “Weighting”, and “More 2D” panels. It is important to note that this experiment employs mix-mode processing, with the F2 dimension absolute value and F1 phase-sensitive. This arrangement allows for the best resolution and sensitivity combination.

Tips, tricks, and next steps

- Spectral width (sw) setting transfers from a PROTON if the gc2hmbc is set up from this experiment. Receiver gain (gain) is usually set to a high value (?30), unless the sample is extremely concentrated or ¹³C-labelled.
- The default number of steady state scans (ss) that are acquired before data acquisition to establish sample equilibrium is 32, which works for most samples. This value is changed on the “Acquisition” panel of the “Acquire” tab if necessary.
- The default parameters use a Grad-90-Grad steady state between scans, which helps cleanup un-relaxed magnetization. This can result in much cleaner spectra, especially when using shorter acquisition times (at) and relaxation delays (d1) (defaults are 0.15s and 1s, respectively).
- In general, the HMBC-type experiments have the best sensitivity of the Jn(CH)corr experiments- the other experiments provide specialized data for specific information types.

- The `jnxh` sets the optimal value of the proton-carbon coupling constant for detection. Using smaller values may increase the chances of seeing longer-range correlations, but at the expense of correlations with larger coupling constants, and, more importantly, at the expense of sensitivity loss. The CIGARAD experiment is better suited on a reasonably concentrated sample for detecting longer range correlations from a range of coupling constants, but at the expense of sensitivity.
- The experiment features a 2-step low-pass filter that can eliminate undesired crosspeaks from one-bond couplings. Select two coupling constants on the “Pulse Sequence” panel around which one-bond couplings are eliminated (default values are 165 and 130 Hz). These filters are rather narrow-band, however, and if the spread of coupling constants is such that some couplings lie considerably outside these values (for example 115 or 145 Hz), its signals may still be visible in the spectrum. As HMBC-type spectra are recorded without ^{13}C decoupling, such signals can usually still be discerned from long-range crosspeaks by their one-bond splitting.
- The `gc2hmbcme` uses adiabatic or bip 180° carbon and proton pulses for much improved uniform inversion as well as for tolerance to RF inhomogeneity and/or pulse calibration imperfection.

References:

- A. Bax, M. F. Summers, *J. Am. Chem. Soc.* 108 (1996) 2093-2094 (HMBC)
- H. Hu, K. Krishnamurthy, *Magn. Reson. Chem.* 46 (2008) 683-689. (CRISIS2 with Multiplicity Editing)

gc2hsqcse

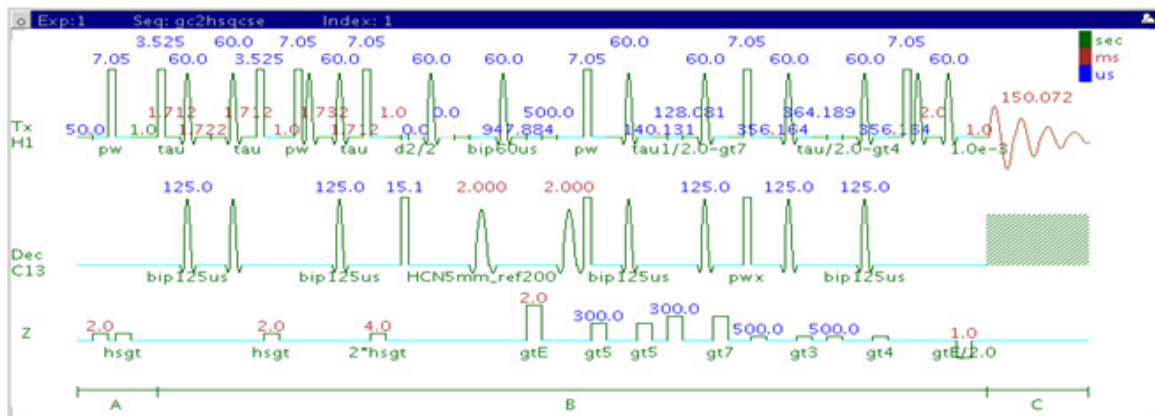

General description and usage

Description:

Two Dimensional heteronuclear single-quantum 1-bond J-correlation spectroscopy with bip and/or adiabatic 180° pulses, sensitivity enhancement, and gradient coherence selection.

Usage:

The gc2hsqcse experiment is used to acquire a 2-dimensional spectrum to correlate protons with directly attached carbons. The CRISIS2 (c2) version of this experiment uses either bip or adiabatic 180° pulses in both channels. The experiment is very useful for proton and carbon assignments, because if the proton assignment is known, the carbon assignment can be deduced directly from this data and vice versa. For structure elucidation, carbon chemical shifts are particularly useful as they are highly sensitive to local functional groups and can be more reliably predicted. All parameters are set from the “Acquire” tab/“Defaults” panel unless otherwise specified.

Key parameters

Parameter	Description
Spectral Width (sw)	Set from previously acquired PROTON*
Acquisition time (at)	Set from "Pulse Sequence" panel, controls the resolution in F2, default 0.15s
F1 Nucleus (dn)	Pull- down menu to set F1 nucleus to ^{13}C , ^{15}N , or other*
C13 Spectral Width (ppm)	Type in desired chemical shift range for F1 dimension
Scans per t1 increment (nt)	Select typical choices from pull down menu*
t1 Increments (ni)	Select typical choices from pull down menu*- controls the resolution in F1 (minimum ~64)
One-Bond J1xh (j1xh)	Set value for the average $^1\text{J}_{\text{X,H}}$ - 146 Hz works well for many carbons
H1-C13 Multiplicity Editing	Check box to turn on/off multiplicity editing
Steady State (ss)	Set from "Pulse Sequence" panel, turn on/off gradient cleanup between scans
C12-H1 suppression	Set from "Pulse Sequence" panel- controls type of ^{12}C suppression- default is TANGO-Gradient (highly recommended)

NOTE

Specific values for these parameters may be typed manually in the appropriate boxes on the "Acquisition" or "Pulse Sequence" panels.

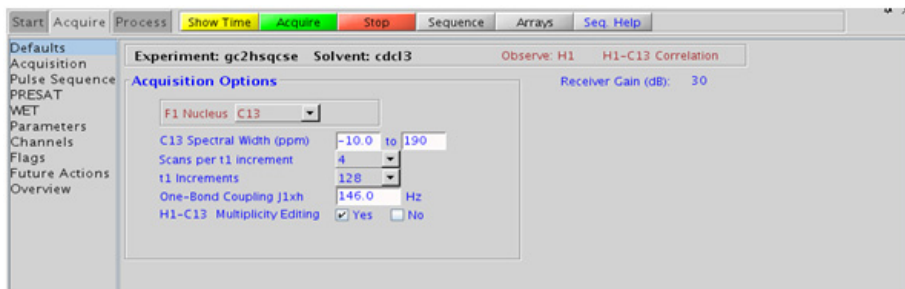

Processing

Automated processing is turned on by default, and the parameters are set to reasonable values, such that the resulting data after the acquisition usually require no further adjustment. The “Process” tab/“Basic” panel contains many of the commonly modified processing parameters, such as a pull-down menu to change the FT data size (1k x 1k is the default), as well as a check box to turn on/off linear prediction and a pull-down to control the extent of linear prediction (default is 4*ni). Menus to quickly change the weighting functions in F2/F1 are also present (defaults are gaussians); the parameters for the weighting functions are calculated automatically from the acquisition time and number of increments. More processing details are found under some of the other “Process” panels, such as the “Default”, “Weighting”, and “More 2D” panels.

Tips, tricks, and next steps

- Spectral width (sw) setting transfers from a PROTON if the gc2hsqcse is set up from this experiment. Receiver gain (gain) is usually set to a high value (?30), unless the sample is extremely concentrated or ¹³C-labelled.
- To measure ¹H-¹³C (or ¹H-X) coupling constants, the carbon decoupling can be turned off by entering “nnn” in the Channel 2 “Dec On/Off” entry on the “Channels” panel or alternatively by typing dm='nnn' on the command line.
- The default number of steady state scans (ss) that are acquired before data acquisition to establish sample equilibrium is 32, which works for most samples. However, higher power carbon decoupling may cause some perturbations that may necessitate more ss scans to reach equilibrium. This value is changed on the “Acquisition” panel of the “Acquire” tab if necessary.
- The default parameters use a Grad-90-Grad steady state between scans, which helps cleanup un-relaxed magnetization. This can result in much cleaner spectra, especially when using shorter acquisition times (at) and relaxation delays (d1) (defaults are 0.15s and 1s, respectively).

- Using the multiplicity editing feature results in a spectrum with the peaks from methylene-type carbons having the opposite phase to methyl and methine-type carbons. The experiment uses the CRISIS technique to minimize sensitivity loss due to unmatched coupling constants and echo time. CRISIS based multiplicity editing is on by default.
- The c2hsqcse experiment has a comparable sensitivity to the gc2hsqcse, but due to t1 noise from strong signals such as t-butyl, may produce potentially less clean spectra than its gradient counterpart.
- The gc2hsqcse uses adiabatic or bip 180° carbon and proton pulses for much improved uniform inversion as well as for tolerance to RF inhomogeneity and/or pulse calibration imperfection.
- The gc2hsqcse has a sensitivity enhancement feature which, in theory, can result in an increase of approximately a factor of 0.7-1.4 over c2hsqc and a factor of 1 to 2 over gc2hsqc.
- Datasets with moderate S/N are better processed with 2*ni linear prediction instead of the default (4*ni). Remember to reset the window function along F1 axis if linear prediction parameters are changed.

References:

G. Bodenhausen, D. J. Ruben, Chem. Phys. Lett. 69 (1980) 185-189. (HSQC)

A. G. Palmer III, J. Cavanagh, P. E. Wright, M. Rance, J. Magn. Reson. 93 (1991) 151-170. (HSQC)

H. Hu, K. Krishnamurthy, Magn. Reson. Chem. 46 (2008) 683-689. (CRISIS2 with Multiplicity Editing)

gc2hsqc

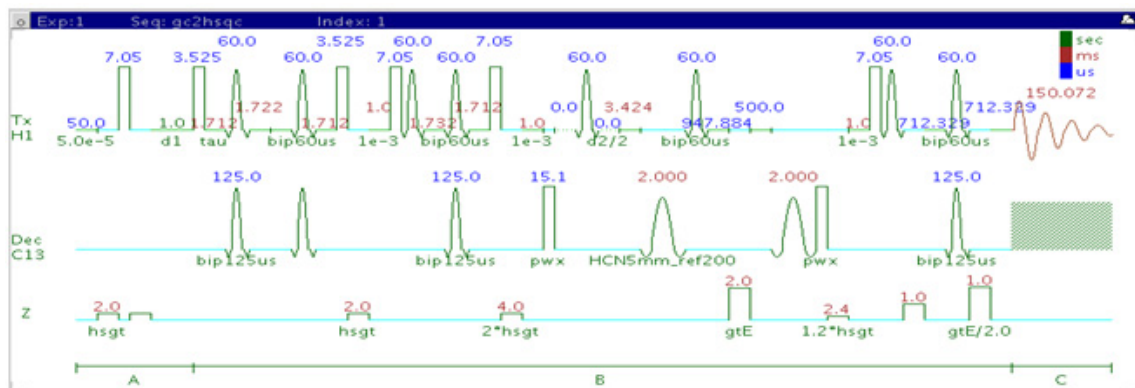

General description and usage

Description:

Two Dimensional heteronuclear single-quantum 1-bond J-correlation spectroscopy with bip and/or adiabatic 180° pulses and gradient coherence selection.

Usage:

The gc2hsqc experiment is used to acquire a 2-dimensional spectrum to correlate protons with directly attached carbons. The CRISIS2 (c2) version of this experiment uses either bip or adiabatic 180° pulses in both channels. The experiment is very useful for proton and carbon assignments, because if the proton assignment is known, the carbon assignment can be deduced directly from this data and vice versa. For structure elucidation, carbon chemical shifts are particularly useful as they are highly sensitive to local functional groups and can be more reliably predicted. All parameters are set from the “Acquire” tab/“Defaults” panel unless otherwise specified.

Key parameters

Parameter	Description
Spectral Width (sw)	Set from previously acquired PROTON*
Acquisition time (at)	Set from "Pulse Sequence" panel, controls the resolution in F2, default 0.15s
F1 Nucleus (dn)	Pull- down menu to set F1 nucleus to ^{13}C , ^{15}N , or other*
C13 Spectral Width (ppm)	Type in desired chemical shift range for F1 dimension
Scans per t1 increment (nt)	Select typical choices from pull down menu*
t1 Increments (ni)	Select typical choices from pull down menu*- controls the resolution in F1 (minimum ~64)
One-Bond J1xh (j1xh)	Set value for the average $^1J_{\text{X,H}}$ - 146 Hz works well for many carbons
H1-C13 Multiplicity Editing	Check box to turn on/off multiplicity editing
Steady State (ss)	Set from "Pulse Sequence" panel, turn on/off gradient cleanup between scans
C12-H1 suppression	Set from "Pulse Sequence" panel- controls type of ^{12}C suppression- default is TANGO-Gradient (highly recommended)

NOTE

Specific values for these parameters may be typed manually in the appropriate boxes on the "Acquisition" or "Pulse Sequence" panels.



Processing

Automated processing is turned on by default, and the parameters are set to reasonable values, such that the resulting data after the acquisition usually require no further adjustment. The “Process” tab/“Basic” panel contains many of the commonly modified processing parameters, such as a pull-down menu to change the FT data size (1k x 1k is the default), as well as a check box to turn on/off linear prediction and a pull-down to control the extent of linear prediction (default is 4*ni). Menus to quickly change the weighting functions in F2/F1 are also present (defaults are gaussians); the parameters for the weighting functions are calculated automatically from the acquisition time and number of increments. More processing details are found under some of the other “Process” panels, such as the “Default”, “Weighting”, and “More 2D” panels.

Tips, tricks, and next steps

- Spectral width (sw) setting transfers from a PROTON if the gc2hsqc is set up from this experiment. Receiver gain (gain) is usually set to a high value (?30), unless the sample is extremely concentrated or ¹³C-labelled.
- To measure ¹H-¹³C (or ¹H-X) coupling constants, the carbon decoupling can be turned off by entering “nnn” in the Channel 2 “Dec On/Off” entry on the “Channels” panel or alternatively by typing dm='nnn' on the command line.
- The default number of steady state scans (ss) that are acquired before data acquisition to establish sample equilibrium is 32, which works for most samples. However, higher power carbon decoupling may cause some perturbations that may necessitate more ss scans to reach equilibrium. This value is changed on the “Acquisition” panel of the “Acquire” tab if necessary.
- The default parameters use a Grad-90-Grad steady state between scans, which helps cleanup un-relaxed magnetization. This can result in much cleaner spectra, especially when using shorter acquisition times (at) and relaxation delays (d1) (defaults are 0.15s and 1s, respectively).

- Using the multiplicity editing feature results in a spectrum with the peaks from methylene-type carbons having the opposite phase to methyl and methine-type carbons. The experiment uses the CRISIS technique to minimize sensitivity loss due to unmatched coupling constants and echo time. CRISIS based multiplicity editing is on by default.
- The c2hsqc experiment has a sensitivity advantage (factor of ~ 1.4) over the gc2hsqc, but due to t1 noise from strong signals such as t-butyl, may produce potentially less clean spectra than its gradient counterpart.
- The gc2hsqc uses adiabatic or bip 180° carbon and proton pulses for much improved uniform inversion as well as for tolerance to RF inhomogeneity and/or pulse calibration imperfection.
- Datasets with moderate S/N are better processed with 2*ni linear prediction instead of the default (4*ni). Remember to reset the window function along F1 axis if linear prediction parameters are changed.

References:

G. Bodenhausen, D. J. Ruben, Chem. Phys. Lett. 69 (1980) 185-189. (HSQC)

A. G. Palmer III, J. Cavanagh, P. E. Wright, M. Rance, J. Magn. Reson. 93 (1991) 151-170. (HSQC)

H. Hu, K. Krishnamurthy, Magn. Reson. Chem. 46 (2008) 683-689. (CRISIS2 with Multiplicity Editing)

8 Heteronuclear CRISIS2- (HC)Crisis2
Tips, tricks, and next steps



9 Hetero-TOCSY - (HC)HetToxys

(HC)HetToxys Tab	332
HSQCADTOXY	334
gHSQCADTOXY	340
HSQCTOXY	346
gHSQCTOXY	352
HMQCTOXY	358
gHMQCTOXY	364



(HC)HetToxys Tab

The (HC)HetToxys family of experiments can be used to resolve ambiguous assignments and/or overlap issues that are not resolved after the analysis of a more common set of 2D experiments such as a zTOCSY and a gHSQCAD. These experiments provide two pieces of information; first, typically a correlation is generated that is the same as in the gHSQCAD, for example, “This proton is attached to that carbon”. Second, a series of correlations are generated that are redundant in both F2, the proton dimension, and in F1, the carbon dimension. The information conveyed is “The proton at this chemical shift is coupled to a proton whose carbon is at that chemical shift”.

The most sensitive experiment in the family is the HSQCADTOXY, which, along with the gHSQCADTOXY, has adiabatic 180° carbon pulses. The gradient enhanced version of the experiment does experience better artifact suppression, but at the expense of a loss of sensitivity (factor of ~ 1.4). The gradient enhanced version of these experiments can also suffer from additional sensitivity loss due to diffusion during the mixing time if the analyte is small and/or the solvent is non-viscous. Typically, consider using the non-gradient coherence selection version, with the HSQCADTOXY as the recommended choice. The non-adiabatic experiments in the HetToxy family, however, provide an option to invert or suppress only the responses directly attributed to the H-C pair (HSQC peaks), which can be advantageous for cases of severe overlap in the ^1H dimension.

The (HC)HetToxy family of experiments are very powerful for helping to solve structural problems with many classes of chemical substances wherever there is resonance overlap in the proton spectrum. In compounds such as peptides it is often useful to acquire HSQCADTOXY data for both H-C and H-N. Provided the ^{15}N chemical shifts of each amide are resolved, it is possible to effectively separate the complete ^1H NMR spectrum for each amino acid in the F1 (^{15}N) dimension. Subsequent consultation of the H-C HSQCADTOXY spectrum can make it straightforward to verify all assignments for the carbons as well.

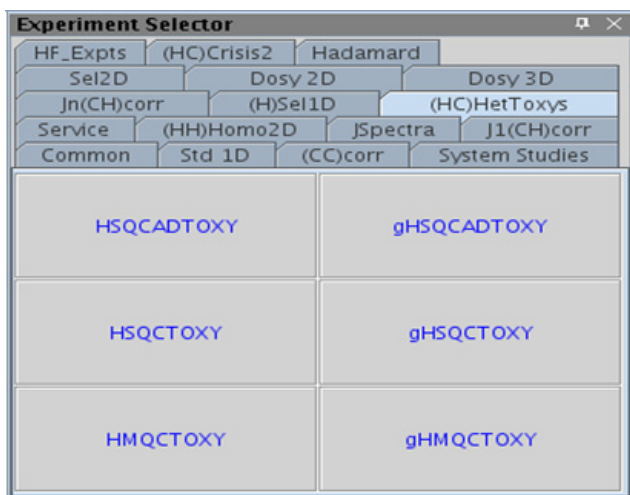

HSQCADTOXY

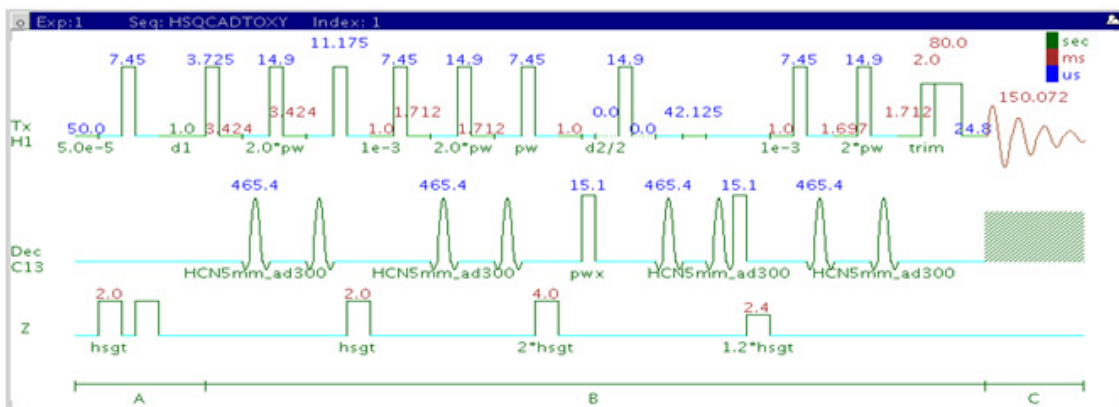

General description and usage

Description:

Two Dimensional heteronuclear single-quantum 1-bond J-correlation spectroscopy with a TOCSY spinlock and adiabatic 180° X-nuclei pulses.

Usage:

The HSQCADTOXY experiment is used to acquire a 2-dimensional spectrum to collect information correlating ^1H - ^1H TOCSY and ^{13}C chemical shift information, for example, Proton A is in the same spin system as proton B at carbon chemical shift X. The experiment is useful to resolve overlapping spin systems in the ^1H - ^1H TOCSY spectrum by spreading them out over the carbon (or other X-nuclei) chemical shift range. All parameters are set from the “Acquire” tab/”Defaults” panel unless otherwise specified.

Key parameters

Parameter	Description
Spectral Width (sw)	Set from previously acquired PROTON*
Acquisition time (at)	Set from "Pulse Sequence" panel, controls the resolution in F2, default 0.15s
F1 Nucleus (dn)	Pull- down menu to set F1 nucleus to ^{13}C , ^{15}N , or other*
C13 Spectral Width (ppm)	Type in desired chemical shift range for F1 dimension
Scans per t1 increment (nt)	Select typical choices from pull down menu*
t1 Increments (ni)	Select typical choices from pull down menu*- controls the resolution in F1 (minimum ~64)
One-Bond J1xh (j1xh)	Set value for the average $^1J_{\text{X,H}}$ - 146 Hz works well for many carbons
Spinlock Duration (mixT)	Select from pull down menu- 80ms works best for large spin systems*
C12-H1 suppression	Check box to turn on/off on the "Pulse Sequence" panel- controls TANGO-Gradient ^{12}C suppression, default is on (highly recommended)

NOTE

Specific values for these parameters may be typed manually in the appropriate boxes on the "Acquisition" or "Pulse Sequence" panels.

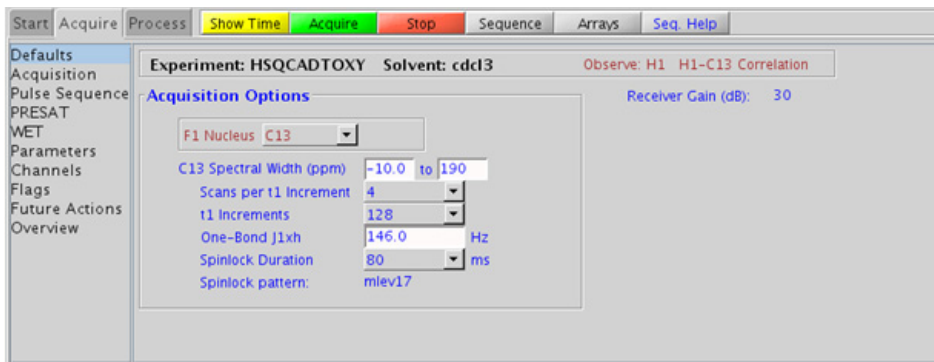

Processing

Automated processing is turned on by default, and the parameters are set to reasonable values, such that the resulting data after the acquisition usually require no further adjustment. The “Process” tab/“Basic” panel contains many of the commonly modified processing parameters, such as a pull-down menu to change the FT data size (1k x 1k is the default), as well as a check box to turn on/off linear prediction and a pull-down to control the extent of linear prediction (default is 4*ni). Menus to quickly change the weighting functions in F2/F1 are also present (defaults are gaussians); the parameters for the weighting functions are calculated automatically from the acquisition time and number of increments. More processing details are found under some of the other “Process” panels, such as the “Default”, “Weighting”, and “More 2D” panels.

Tips, tricks, and next steps

- Spectral width (sw) setting transfers from a PROTON if the HSQCADTOXY is set up from this experiment. Setup from a TOCSY-type or HSQC-type experiment transfers TOCSY- or HSQC-related parameters, respectively. Receiver gain (gain) is usually set to a high value (?30), unless the sample is extremely concentrated or ¹³C-labelled.
- To measure ¹H-¹³C (or ¹H-X) coupling constants, the carbon decoupling can be turned off by entering “nnn” in the Channel 2 “Dec On/Off” entry on the “Channels” panel or alternatively by typing dm='nnn' on the command line.
- The spinlock time (in addition to the magnitude of the coupling constants) ultimately controls how far along the spin system the correlations extend. Use spinlock durations exceeding 150ms with caution, as this can result in sample heating. The efficiency of the TOCSY transfer is directly proportional to the size of the coupling constants between the pairs of protons. To show primarily vicinal and geminal couplings, select a shorter spinlock time, for example, 30ms or less.
- The type of spinlock can be changed from mlev17 (for smaller molecules) to clean mlev17 (for larger molecules on the “Pulse Sequence” tab).

- The default number of steady state scans (ss) that are acquired before data acquisition to establish sample equilibrium is 32, which works for most samples. However, higher power carbon decoupling may cause some perturbations that may necessitate more ss scans to reach equilibrium. This value is changed on the “Acquisition” panel of the “Acquire” tab if necessary.
- The default parameters use a Grad-90-Grad steady state between scans, which helps cleanup un-relaxed magnetization. This can result in much cleaner spectra, especially when using shorter acquisition times (at) and relaxation delays (d1) (defaults are 0.15s and 1s, respectively).
- The HSQCADTOXY experiment, like all other heteronuclear TOCSYs, is an experiment with a lower sensitivity than the respective simple, single bond correlation experiment. This is because the magnetization generated during the initial HSQC stage is then distributed along the ^1H coupling network. Thus, a higher number of transients per increment are required unless the sample is very concentrated.
- In general, the HSQC-type experiments provide spectra with narrower peaks shapes (by suppressing ^1H - ^1H homonuclear coupling modulation in F1) than the HMQC-types, typically leading to better S/N and resolution.
- The HSQCADTOXY experiment has a sensitivity advantage (factor of ~ 1.4) over the gHSQCADTOXY, but may produce potentially less clean spectra (due to t1 noise from strong signals such as t-butyl) than its gradient counterpart. The gradient enhanced version of these experiments can also suffer from additional sensitivity loss due to diffusion during the mixing time if the analyte is small and/or the solvent is non-viscous. Typically, consider using the non-gradient coherence selection version.
- The HSQCADTOXY uses adiabatic 180° carbon pulses and often gives better results than the HSQCCTOXY, particularly when the carbon pulses are not perfectly calibrated for the given sample. In addition, the adiabatic 180° pulses provide a much more uniform inversion over a wide ^{13}C spectral width.

References:

E. Kupce, R. Freeman, J. Magn. Reson. Ser. A 117 (1995) 246-256.
 (Adiabatic Pulses)

9 Hetero-TOCSY - (HC)HetToxys

Tips, tricks, and next steps

K. E. Kover, O. Prakash, V. J. Hruby, J. Magn. Reson. A103 (1993) 92-96.
(z-filtered HSQC-TOCSY)

gHSQCADTOXY

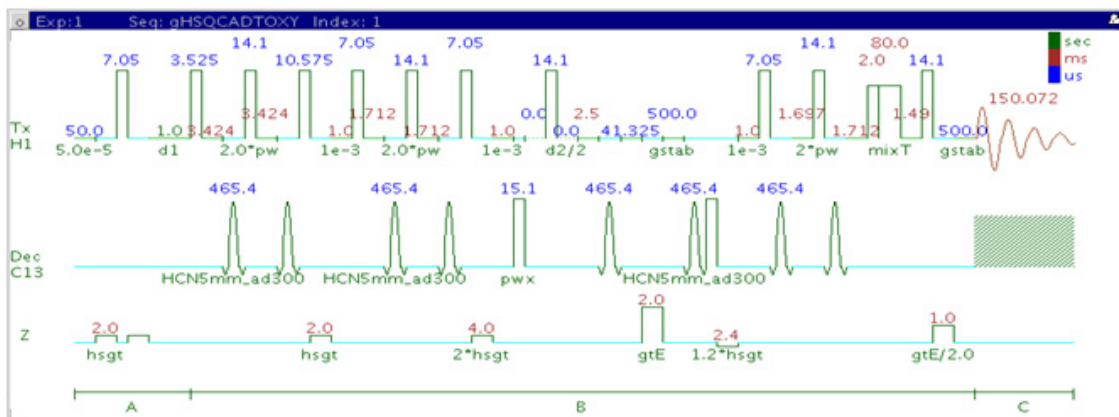

General description and usage

Description:

Two Dimensional heteronuclear single-quantum 1-bond J-correlation spectroscopy with a TOCSY spinlock, adiabatic 180° X-nuclei pulses, and gradient coherence selection.

Usage:

The gHSQCADTOXY experiment is used to acquire a 2-dimensional spectrum to collect information correlating ^1H - ^1H TOCSY and ^{13}C chemical shift information, for example, Proton A is in the same spin system as proton B at carbon chemical shift X. The experiment is useful to resolve overlapping spin systems in the ^1H - ^1H TOCSY spectrum by spreading them out over the carbon (or other X-nuclei) chemical shift range. All parameters are set from the “Acquire” tab/”Defaults” panel unless otherwise specified.

Key parameters

Parameter	Description
Spectral Width (sw)	Set from previously acquired PROTON*
Acquisition time (at)	Set from "Pulse Sequence" panel, controls the resolution in F2, default 0.15s
F1 Nucleus (dn)	Pull- down menu to set F1 nucleus to ^{13}C , ^{15}N , or other*
C13 Spectral Width (ppm)	Type in desired chemical shift range for F1 dimension
Scans per t1 increment (nt)	Select typical choices from pull down menu*
t1 Increments (ni)	Select typical choices from pull down menu*- controls the resolution in F1 (minimum ~64)
One-Bond J1xh (j1xh)	Set value for the average $^1J_{\text{X,H}}$ - 146 Hz works well for many carbons
Spinlock Duration (mixT)	Select from pull down menu- 80ms works best for large spin systems*
C12-H1 suppression	Check box to turn on/off on the "Pulse Sequence" panel- controls TANGO-Gradient ^{12}C suppression, default is on (highly recommended)

NOTE

Specific values for these parameters may be typed manually in the appropriate boxes on the "Acquisition" or "Pulse Sequence" panels.

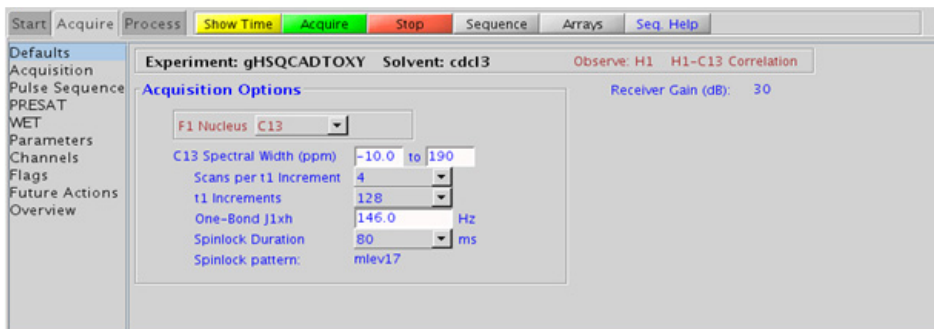

Processing

Automated processing is turned on by default, and the parameters are set to reasonable values, such that the resulting data after the acquisition usually require no further adjustment. The “Process” tab/“Basic” panel contains many of the commonly modified processing parameters, such as a pull-down menu to change the FT data size (1k x 1k is the default), as well as a check box to turn on/off linear prediction and a pull-down to control the extent of linear prediction (default is 4*ni). Menus to quickly change the weighting functions in F2/F1 are also present (defaults are gaussians); the parameters for the weighting functions are calculated automatically from the acquisition time and number of increments. More processing details are found under some of the other “Process” panels, such as the “Default”, “Weighting”, and “More 2D” panels.

Tips, tricks, and next steps

- Spectral width (sw) setting transfers from a PROTON if the gHSQCADTOXY is set up from this experiment. Setup from a TOCSY-type or HSQC-type experiment transfers TOCSY- or HSQC-related parameters, respectively. Receiver gain (gain) is usually set to a high value (≥ 30), unless the sample is extremely concentrated or ^{13}C -labelled.
- To measure ^1H - ^{13}C (or ^1H -X) coupling constants, the carbon decoupling can be turned off by entering “nnn” in the Channel 2 “Dec On/Off” entry on the “Channels” panel or alternatively by typing `dm='nnn'` on the command line.
- The spinlock time (in addition to the magnitude of the coupling constants) ultimately controls how far along the spin system the correlations extend. Use spinlock durations exceeding 150ms with caution, as this can result in sample heating. The efficiency of the TOCSY transfer is directly proportional to the size of the coupling constants between the pairs of protons. To show primarily vicinal and geminal couplings, select a shorter spinlock time, for example, 30ms or less.
- The type of spinlock can be changed from mlev17 (for smaller molecules) to clean mlev17 (for larger molecules on the “Pulse Sequence” tab).

- The default number of steady state scans (ss) that are acquired before data acquisition to establish sample equilibrium is 32, which works for most samples. However, higher power carbon decoupling may cause some perturbations that may necessitate more ss scans to reach equilibrium. This value is changed on the “Acquisition” panel of the “Acquire” tab if necessary.
- The default parameters use a Grad-90-Grad steady state between scans, which helps cleanup un-relaxed magnetization. This can result in much cleaner spectra, especially when using shorter acquisition times (at) and relaxation delays (d1) (defaults are 0.15s and 1s, respectively).
- The gHSQCADTOXY experiment, like all other heteronuclear TOCSYs, is an experiment with a lower sensitivity than the respective simple, single bond correlation experiment. This is because the magnetization generated during the initial HSQC stage is then distributed along the ^1H coupling network. Thus, a higher number of transients per increment are required unless the sample is very concentrated.
- In general, the HSQC-type experiments provide spectra with narrower peaks shapes (by suppressing ^1H - ^1H homonuclear coupling modulation in F1) than the HMQC-types, typically leading to better S/N and resolution.
- The HSQCADTOXY experiment has a sensitivity advantage (factor of ~ 1.4) over the gHSQCADTOXY, but may produce potentially less clean spectra (due to t1 noise from strong signals such as t-butyl) than its gradient counterpart. The gradient enhanced version of these experiments can also suffer from additional sensitivity loss due to diffusion during the mixing time if the analyte is small and/or the solvent is non-viscous. Typically, consider using the non-gradient coherence selection version.
- The gHSQCADTOXY uses adiabatic 180° carbon pulses and often gives better results than the gHSQCCTOXY, particularly when the carbon pulses are not perfectly calibrated for the given sample. In addition, the adiabatic 180° pulses provide a much more uniform inversion over a wide ^{13}C spectral width.

References:

E. Kupce, R. Freeman, J. Magn. Reson. Ser. A 117 (1995) 246-256.
 (Adiabatic Pulses)

9 Hetero-TOCSY - (HC)HetToxys

Tips, tricks, and next steps

R. E. Hurd, J. Magn. Reson. 87 (1990) 422-428. (Gradient based Coherence Selection)

K. E. Kover, O. Prakash, V, J. Hruby, J. Magn. Reson. A103 (1993) 92-96. (z-filtered HSQC-TOCSY)

HSQCTOXY

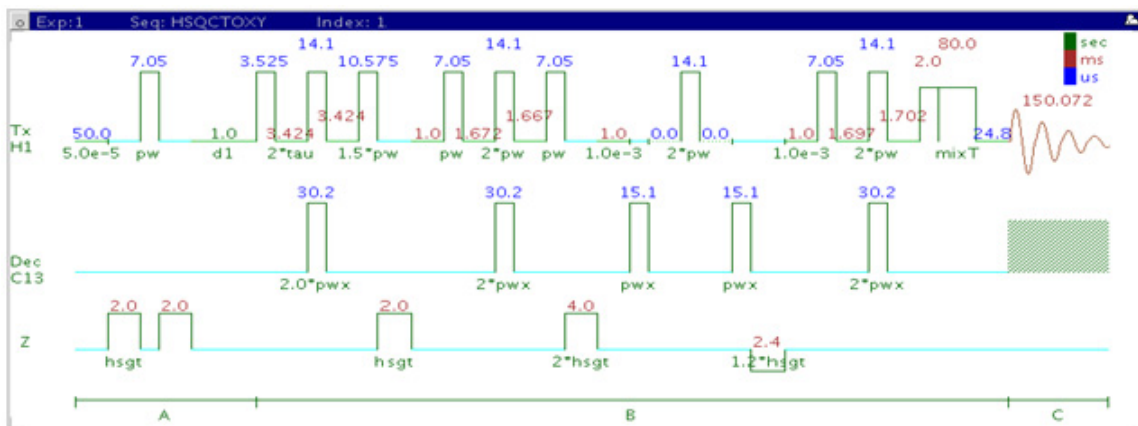

General description and usage

Description:

Two Dimensional heteronuclear single-quantum 1-bond J-correlation spectroscopy with a TOCSY spinlock and adiabatic 180° X-nuclei pulses.

Usage:

The HSQCTOXY experiment is used to acquire a 2-dimensional spectrum to collect information correlating ¹H-¹H TOCSY and ¹³C chemical shift information, for example, Proton A is in the same spin system as proton B at carbon chemical shift X. The experiment is useful to resolve overlapping spin systems in the ¹H-¹H TOCSY spectrum by spreading them out over the carbon (or other X-nuclei) chemical shift range. All parameters are set from the “Acquire” tab/”Defaults” panel unless otherwise specified.

Key parameters

Parameter	Description
Spectral Width (sw)	Set from previously acquired PROTON*
Acquisition time (at)	Set from "Pulse Sequence" panel, controls the resolution in F2, default 0.15s
F1 Nucleus (dn)	Pull- down menu to set F1 nucleus to ^{13}C , ^{15}N , or other*
C13 Spectral Width (ppm)	Type in desired chemical shift range for F1 dimension
Scans per t1 increment (nt)	Select typical choices from pull down menu*
t1 Increments (ni)	Select typical choices from pull down menu*- controls the resolution in F1 (minimum ~64)
One-Bond J1xh (j1xh)	Set value for the average $^1J_{\text{X,H}}$ - 146 Hz works well for many carbons
Spinlock Duration (mixT)	Select from pull down menu- 80ms works best for large spin systems*
Invert H1-C13 Direct Corr.?	Check box to invert direct proton-carbon correlation
C12-H1 suppression	Check box to turn on/off on the "Pulse Sequence" panel- controls TANGO-Gradient ^{12}C suppression, default is on (highly recommended)

NOTE

Specific values for these parameters may be typed manually in the appropriate boxes on the "Acquisition" or "Pulse Sequence" panels.

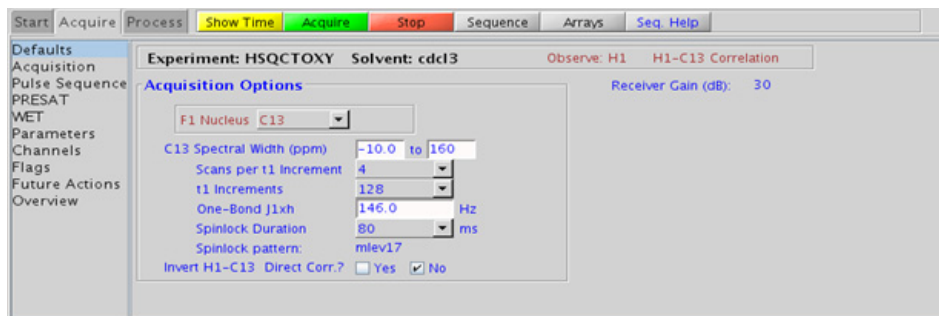

Processing

Automated processing is turned on by default, and the parameters are set to reasonable values, such that the resulting data after the acquisition usually require no further adjustment. The “Process” tab/“Basic” panel contains many of the commonly modified processing parameters, such as a pull-down menu to change the FT data size (1k x 1k is the default), as well as a check box to turn on/off linear prediction and a pull-down to control the extent of linear prediction (default is 4*ni). Menus to quickly change the weighting functions in F2/F1 are also present (defaults are gaussians); the parameters for the weighting functions are calculated automatically from the acquisition time and number of increments. More processing details are found under some of the other “Process” panels, such as the “Default”, “Weighting”, and “More 2D” panels.

Tips, tricks, and next steps

- Spectral width (sw) setting transfers from a PROTON if the HSQCTOXY is set up from this experiment. Setup from a TOCSY-type or HSQC-type experiment transfers TOCSY- or HSQC-related parameters, respectively. Receiver gain (gain) is usually set to a high value (≥ 30), unless the sample is extremely concentrated or ^{13}C -labelled.

- To measure ^1H - ^{13}C (or ^1H -X) coupling constants, the carbon decoupling can be turned off by entering “nnn” in the Channel 2 “Dec On/Off” entry on the “Channels” panel or alternatively by typing dm='nnn' on the command line.
- The spinlock time (in addition to the magnitude of the coupling constants) ultimately controls how far along the spin system the correlations extend. Use spinlock durations exceeding 150ms with caution, as this can result in sample heating. The efficiency of the TOCSY transfer is directly proportional to the size of the coupling constants between the pairs of protons. To show primarily vicinal and geminal couplings, select a shorter spinlock time, for example, 30ms or less.
- The type of spinlock can be changed from mlev17 (for smaller molecules) to clean mlev17 (for larger molecules on the “Pulse Sequence” tab).
- The default number of steady state scans (ss) that are acquired before data acquisition to establish sample equilibrium is 32, which works for most samples. However, higher power carbon decoupling may cause some perturbations that may necessitate more ss scans to reach equilibrium. This value is changed on the “Acquisition” panel of the “Acquire” tab if necessary.
- The default parameters use a Grad-90-Grad steady state between scans, which helps cleanup un-relaxed magnetization. This can result in much cleaner spectra, especially when using shorter acquisition times (at) and relaxation delays (d1) (defaults are 0.15s and 1s, respectively).
- On the “Pulse Sequence” tab there is a pull-down menu to select in-phase, inverted, or suppressed XH direct correlations. There is a minor sensitivity loss with this feature, however the extra information is obtained with no additional cost in experiment time. When direct correlations suppression is chosen the ^{13}C decoupling can be turned off to place any residual direct correlations away from the true ^1H chemical shifts. This can allow the observation of ^1H - ^1H J-connectivity between protons with very close overlap.
- The HSQCTOXY experiment, like all other heteronuclear TOCSYs, is an experiment with a lower sensitivity than the respective simple, single bond correlation experiment. This is because the magnetization generated during the initial HSQC stage is then distributed along the ^1H coupling network. Thus, a higher number of transients per increment are required unless the sample is very concentrated.

- In general, the HSQC-type experiments provide spectra with narrower peaks shapes (by suppressing ^1H - ^1H homonuclear coupling modulation in F1) than the HMQC-types, typically leading to better S/N and resolution.
- The HSQCTOXY experiment has a sensitivity advantage (factor of ~ 1.4) over the gHSQCTOXY, but may produce potentially less clean spectra (due to t1 noise from strong signals such as t-butyl) than its gradient counterpart. The gradient enhanced version of these experiments can also suffer from additional sensitivity loss due to diffusion during the mixing time if the analyte is small and/or the solvent is non-viscous. Typically, consider using the non-gradient coherence selection version.
- The HSQCADTOXY and gHSQCADTOXY use adiabatic 180° carbon pulses and often give better results than the HSQC, particularly when the carbon pulses are not perfectly calibrated for the given sample. In addition, the adiabatic 180° pulses provide a much more uniform inversion over a wide ^{13}C spectral width.

References:

E. Kupce, R. Freeman, J. Magn. Reson. Ser. A 117 (1995) 246-256.
(Adiabatic Pulses)

K. E. Kover, O. Prakash, V. J. Hruby, J. Magn. Reson. A103 (1993) 92-96.
(z-filtered HSQC-TOCSY)

R. D. Boyer, R. Johnson, K. Krishnamurthy, J. Magn. Reson. 165 (2003)
253-259 (Multiplicity Editing)

gHSQCTOXY

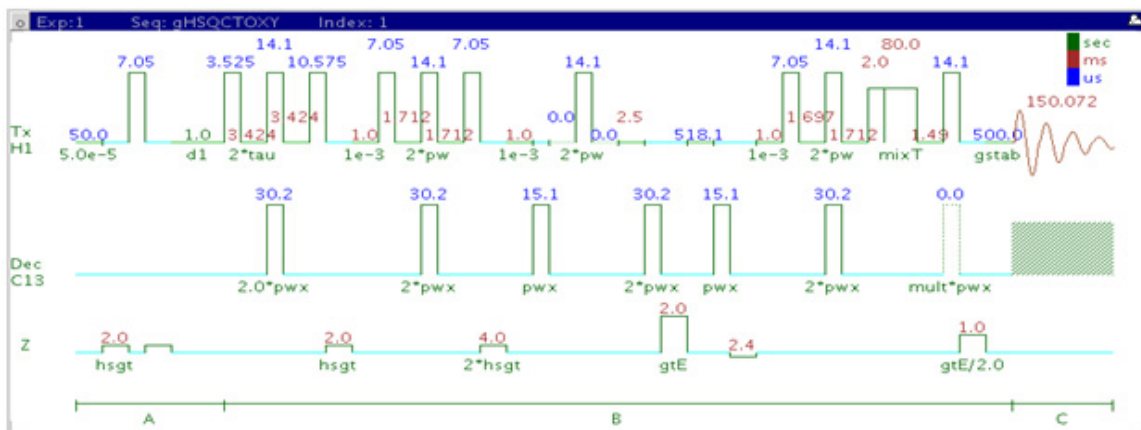

General description and usage

Description:

Two Dimensional heteronuclear single-quantum 1-bond J-correlation spectroscopy with a TOCSY spinlock, adiabatic 180° X-nuclei pulses, and gradient coherence selection.

Usage:

The gHSQCTOXY experiment is used to acquire a 2-dimensional spectrum to collect information correlating ^1H - ^1H TOCSY and ^{13}C chemical shift information, for example, Proton A is in the same spin system as proton B at carbon chemical shift X. The experiment is useful to resolve overlapping spin systems in the ^1H - ^1H TOCSY spectrum by spreading them out over the carbon (or other X-nuclei) chemical shift range. All parameters are set from the “Acquire” tab/”Defaults” panel unless otherwise specified.

Key parameters

Parameter	Description
Spectral Width (sw)	Set from previously acquired PROTON*
Acquisition time (at)	Set from "Pulse Sequence" panel, controls the resolution in F2, default 0.15s
F1 Nucleus (dn)	Pull- down menu to set F1 nucleus to ^{13}C , ^{15}N , or other*
C13 Spectral Width (ppm)	Type in desired chemical shift range for F1 dimension
Scans per t1 increment (nt)	Select typical choices from pull down menu*
t1 Increments (ni)	Select typical choices from pull down menu*- controls the resolution in F1 (minimum ~64)
One-Bond J1xh (j1xh)	Set value for the average $^1J_{\text{X,H}}$ - 146 Hz works well for many carbons
Spinlock Duration (mixT)	Select from pull down menu- 80ms works best for large spin systems*
Invert H1-C13 Direct Corr.?	Check box to invert direct proton-carbon correlation
C12-H1 suppression	Check box to turn on/off on the "Pulse Sequence" panel- controls TANGO-Gradient ^{12}C suppression, default is on (highly recommended)

NOTE

Specific values for these parameters may be typed manually in the appropriate boxes on the "Acquisition" or "Pulse Sequence" panels.

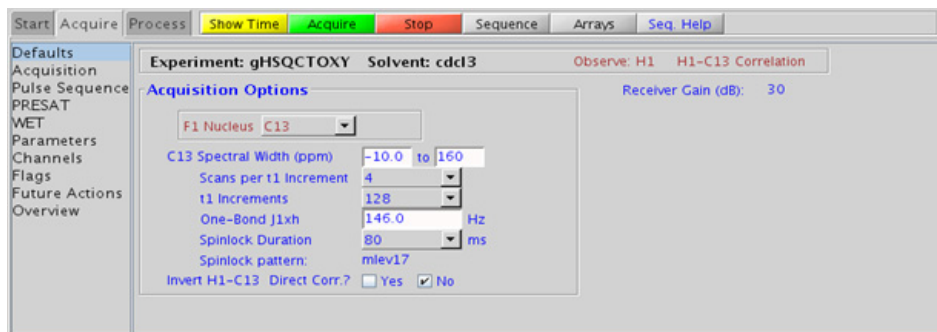

Processing

Automated processing is turned on by default, and the parameters are set to reasonable values, such that the resulting data after the acquisition usually require no further adjustment. The “Process” tab/“Basic” panel contains many of the commonly modified processing parameters, such as a pull-down menu to change the FT data size (1k x 1k is the default), as well as a check box to turn on/off linear prediction and a pull-down to control the extent of linear prediction (default is 4*ni). Menus to quickly change the weighting functions in F2/F1 are also present (defaults are gaussians); the parameters for the weighting functions are calculated automatically from the acquisition time and number of increments. More processing details are found under some of the other “Process” panels, such as the “Default”, “Weighting”, and “More 2D” panels.

Tips, tricks, and next steps

- Spectral width (sw) setting transfers from a PROTON if the gHSQCTOXY is set up from this experiment. Setup from a TOCSY-type or HSQC-type experiment transfers TOCSY- or HSQC-related parameters, respectively. Receiver gain (gain) is usually set to a high value (≥ 30), unless the sample is extremely concentrated or ^{13}C -labelled.

- To measure ^1H - ^{13}C (or ^1H -X) coupling constants, the carbon decoupling can be turned off by entering “nnn” in the Channel 2 “Dec On/Off” entry on the “Channels” panel or alternatively by typing `dm='nnn'` on the command line.
- The spinlock time (in addition to the magnitude of the coupling constants) ultimately controls how far along the spin system the correlations extend. Use spinlock durations exceeding 150ms with caution, as this can result in sample heating. The efficiency of the TOCSY transfer is directly proportional to the size of the coupling constants between the pairs of protons. To show primarily vicinal and geminal couplings, select a shorter spinlock time, for example, 30ms or less.
- The type of spinlock can be changed from `mlev17` (for smaller molecules) to `clean mlev17` (for larger molecules on the “Pulse Sequence” tab).
- The default number of steady state scans (ss) that are acquired before data acquisition to establish sample equilibrium is 32, which works for most samples. However, higher power carbon decoupling may cause some perturbations that may necessitate more ss scans to reach equilibrium. This value is changed on the “Acquisition” panel of the “Acquire” tab if necessary.
- The default parameters use a Grad-90-Grad steady state between scans, which helps cleanup un-relaxed magnetization. This can result in much cleaner spectra, especially when using shorter acquisition times (at) and relaxation delays (d1) (defaults are 0.15s and 1s, respectively).
- On the “Pulse Sequence” tab there is a pull-down menu to select in-phase, inverted, or suppressed XH direct correlations. There is a minor sensitivity loss with this feature, however the extra information is obtained with no additional cost in experiment time. When direct correlations suppression is chosen the ^{13}C decoupling can be turned off to place any residual direct correlations away from the true ^1H chemical shifts. This can allow the observation of ^1H - ^1H J-connectivity between protons with very close overlap.
- The gHSQC TOCSY experiment, like all other heteronuclear TOCSYs, is an experiment with a lower sensitivity than the respective simple, single bond correlation experiment. This is because the magnetization generated during the initial HSQC stage is then distributed along the ^1H coupling network. Thus, a higher number of transients per increment are required unless the sample is very concentrated.

- In general, the HSQC-type experiments provide spectra with narrower peaks shapes (by suppressing ^1H - ^1H homonuclear coupling modulation in F1) than the HMQC-types, typically leading to better S/N and resolution.
- The HSQCTOXY experiment has a sensitivity advantage (factor of ~ 1.4) over the gHSQCTOXY, but may produce potentially less clean spectra (due to t1 noise from strong signals such as t-butyl) than its gradient counterpart. The gradient enhanced version of these experiments can also suffer from additional sensitivity loss due to diffusion during the mixing time if the analyte is small and/or the solvent is non-viscous. Typically, consider using the non-gradient coherence selection version.
- The HSQCADTOXY and gHSQCADTOXY use adiabatic 180° carbon pulses and often give better results than the HSQC, particularly when the carbon pulses are not perfectly calibrated for the given sample. In addition, the adiabatic 180° pulses provide a much more uniform inversion over a wide ^{13}C spectral width.

References:

E. Kupce, R. Freeman, J. Magn. Reson. Ser. A 117 (1995) 246-256.
(Adiabatic Pulses)

K. E. Kover, O. Prakash, V. J. Hruby, J. Magn. Reson. A103 (1993) 92-96.
(z-filtered HSQC-TOCSY)

R. D. Boyer, R. Johnson, K. Krishnamurthy, J. Magn. Reson. 165 (2003)
253-259 (Multiplicity Editing)

HMQCTOXY

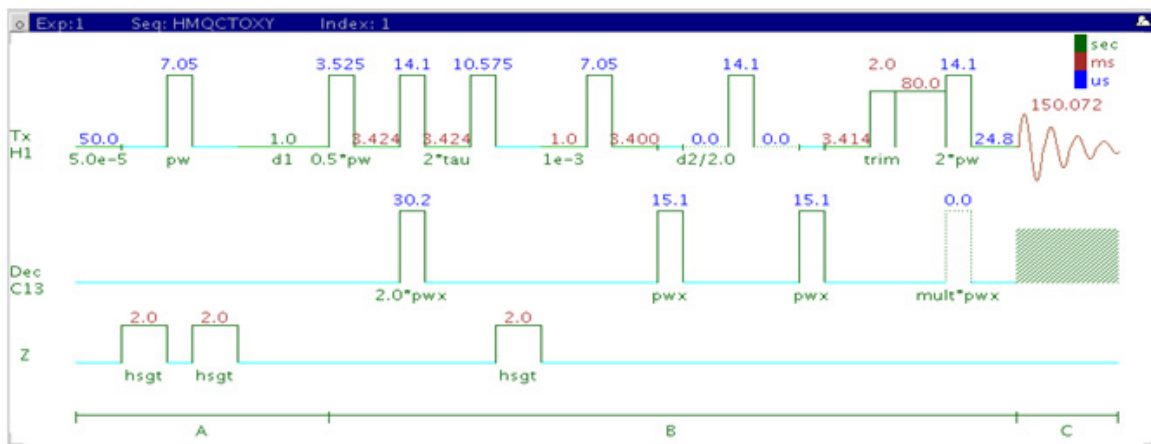

General description and usage

Description:

Two Dimensional heteronuclear multiple-quantum 1-bond J-correlation spectroscopy with a TOCSY spinlock.

Usage:

The HMQCTOXY experiment is used to acquire a 2-dimensional spectrum to collect information correlating ^1H - ^1H TOCSY and ^{13}C chemical shift information, for example, Proton A is in the same spin system as proton B at carbon chemical shift X. The experiment is useful to resolve overlapping spin systems in the ^1H - ^1H TOCSY spectrum by spreading them out over the carbon (or other X-nuclei) chemical shift range. All parameters are set from the "Acquire" tab/"Defaults" panel unless otherwise specified.

Key parameters

Parameter	Description
Spectral Width (sw)	Set from previously acquired PROTON*
Acquisition time (at)	Set from "Pulse Sequence" panel, controls the resolution in F2, default 0.15s
F1 Nucleus (dn)	Pull- down menu to set F1 nucleus to ^{13}C , ^{15}N , or other*
C13 Spectral Width (ppm)	Type in desired chemical shift range for F1 dimension
Scans per t1 increment (nt)	Select typical choices from pull down menu*
t1 Increments (ni)	Select typical choices from pull down menu*- controls the resolution in F1 (minimum ~64)
One-Bond J1xh (j1xh)	Set value for the average $^1J_{\text{X,H}}$ - 146 Hz works well for many carbons
Spinlock Duration (mixT)	Select from pull down menu- 80ms works best for large spin systems*
Invert H1-C13 Direct Corr.?	Check box to invert direct proton-carbon correlation
C12-H1 suppression	Check box to turn on/off on the "Pulse Sequence" panel- controls TANGO-Gradient ^{12}C suppression, default is on (highly recommended)

NOTE

Specific values for these parameters may be typed manually in the appropriate boxes on the "Acquisition" or "Pulse Sequence" panels.

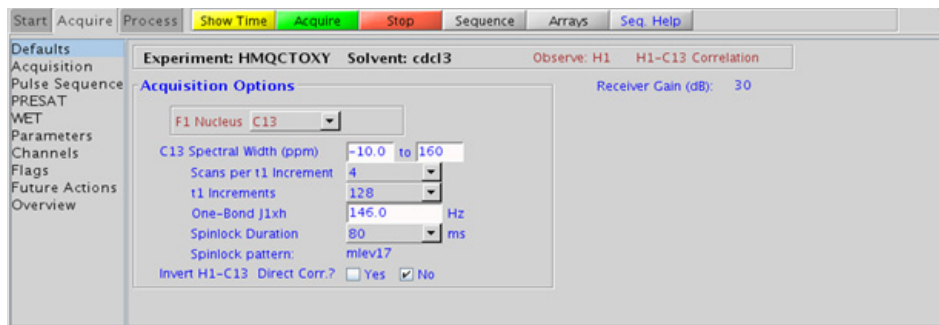

Processing

Automated processing is turned on by default, and the parameters are set to reasonable values, such that the resulting data after the acquisition usually require no further adjustment. The “Process” tab/“Basic” panel contains many of the commonly modified processing parameters, such as a pull-down menu to change the FT data size (1k x 1k is the default), as well as a check box to turn on/off linear prediction and a pull-down to control the extent of linear prediction (default is 4*ni). Menus to quickly change the weighting functions in F2/F1 are also present (defaults are gaussians); the parameters for the weighting functions are calculated automatically from the acquisition time and number of increments. More processing details are found under some of the other “Process” panels, such as the “Default”, “Weighting”, and “More 2D” panels.

Tips, tricks, and next steps

- Spectral width (sw) setting transfers from a PROTON if the HMQCTOXY is set up from this experiment. Setup from a TOCSY-type or HMQC-type experiment transfers TOCSY- or HMQC-related parameters, respectively. Receiver gain (gain) is usually set to a high value (?30), unless the sample is extremely concentrated or ¹³C-labelled.

- To measure ^1H - ^{13}C (or ^1H -X) coupling constants, the carbon decoupling can be turned off by entering “nnn” in the Channel 2 “Dec On/Off” entry on the “Channels” panel or alternatively by typing `dm='nnn'` on the command line.
- The spinlock time (in addition to the magnitude of the coupling constants) ultimately controls how far along the spin system the correlations extend. Use spinlock durations exceeding 150ms with caution, as this can result in sample heating. The efficiency of the TOCSY transfer is directly proportional to the size of the coupling constants between the pairs of protons. To show primarily vicinal and geminal couplings, select a shorter spinlock time, for example, 30ms or less.
- The type of spinlock can be changed from `mlev17` (for smaller molecules) to `clean mlev17` (for larger molecules on the “Pulse Sequence” tab).
- The default number of steady state scans (ss) that are acquired before data acquisition to establish sample equilibrium is 32, which works for most samples. However, higher power carbon decoupling may cause some perturbations that may necessitate more ss scans to reach equilibrium. This value is changed on the “Acquisition” panel of the “Acquire” tab if necessary.
- The default parameters use a Grad-90-Grad steady state between scans, which helps cleanup un-relaxed magnetization. This can result in much cleaner spectra, especially when using shorter acquisition times (at) and relaxation delays (d1) (defaults are 0.15s and 1s, respectively).
- On the “Pulse Sequence” tab there is a pull-down menu to select in-phase, inverted, or suppressed XH direct correlations. There is a minor sensitivity loss with this feature, however the extra information is obtained with no additional cost in experiment time. When direct correlations suppression is chosen the ^{13}C decoupling can be turned off to place any residual direct correlations away from the true ^1H chemical shifts. This can allow the observation of ^1H - ^1H J-connectivity between protons with very close overlap.
- The HMQCTOXY experiment, like all other heteronuclear TOCSYs, is an experiment with a lower sensitivity than the respective simple, single bond correlation experiment. This is because the magnetization generated during the initial HMQC stage is then distributed along the ^1H coupling network. Thus, a higher number of transients per increment are required unless the sample is very concentrated.

9 Hetero-TOCSY - (HC)HetToxys

Tips, tricks, and next steps

- In general, the HSQC-type experiments provide spectra with narrower peaks shapes (by suppressing ^1H - ^1H homonuclear coupling modulation in F1) than the HMQC-types, typically leading to better S/N and resolution.
- The HMQCTOXY experiment has a sensitivity advantage (factor of ~ 1.4) over the gHMQCTOXY, but may produce potentially less clean spectra (due to t1 noise from strong signals such as t-butyl) than its gradient counterpart. The gradient enhanced version of these experiments can also suffer from additional sensitivity loss due to diffusion during the mixing time if the analyte is small and/or the solvent is non-viscous. Typically, consider using the non-gradient coherence selection version.

References:

L. Lerner, A. Bax, J. Magn. Reson. 69 (1986) 375-380. (HMQC-TOCSY)

R. C. Crouch, T. D. Spitzer, G. E. Martin, Magn. Reson. Chem. 30 (1992) S71-S73. (Multiplicity Edited HMQC-TOCSY)

gHMQCTOXY

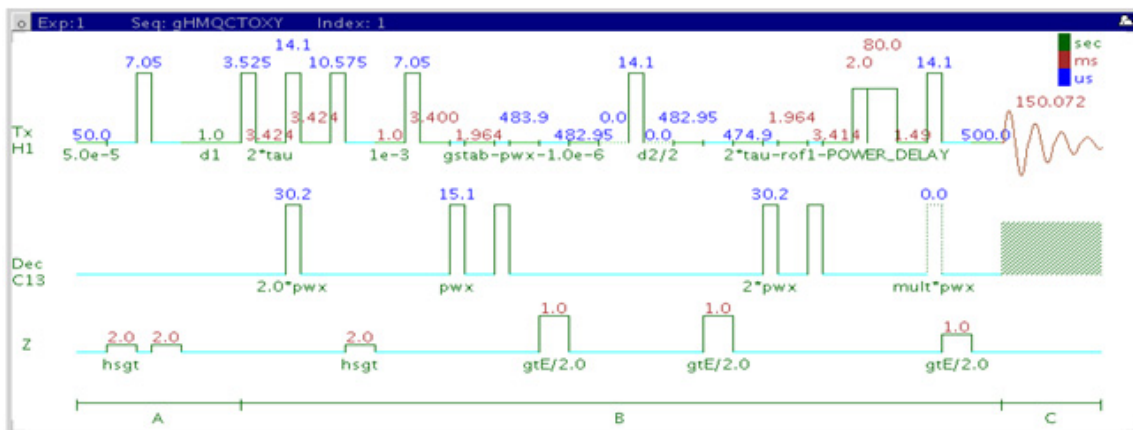

General description and usage

Description:

Two Dimensional heteronuclear multiple-quantum 1-bond J-correlation spectroscopy with a TOCSY spinlock and gradient coherence selection.

Usage:

The gHMQCTOXY experiment is used to acquire a 2-dimensional spectrum to collect information correlating ^1H - ^1H TOCSY and ^{13}C chemical shift information, for example, Proton A is in the same spin system as proton B at carbon chemical shift X. The experiment is useful to resolve overlapping spin systems in the ^1H - ^1H TOCSY spectrum by spreading them out over the carbon (or other X-nuclei) chemical shift range. All parameters are set from the "Acquire" tab/"Defaults" panel unless otherwise specified.

Key parameters

Parameters	Description
Spectral Width (sw)	Set from previously acquired PROTON*
Acquisition time (at)	Set from "Pulse Sequence" panel, controls the resolution in F2, default 0.15s
F1 Nucleus (dn)	Pull- down menu to set F1 nucleus to ^{13}C , ^{15}N , or other*
C13 Spectral Width (ppm)	Type in desired chemical shift range for F1 dimension
Scans per t1 increment (nt)	Select typical choices from pull down menu*
t1 Increments (ni)	Select typical choices from pull down menu*- controls the resolution in F1 (minimum ~64)
One-Bond J1xh (j1xh)	Set value for the average $^1J_{\text{X,H}}$ - 146 Hz works well for many carbons
Spinlock Duration (mixT)	Select from pull down menu- 80ms works best for large spin systems*
Invert H1-C13 Direct Corr.?	Check box to invert direct proton-carbon correlation
C12-H1 suppression	Check box to turn on/off on the "Pulse Sequence" panel- controls TANGO-Gradient ^{12}C suppression, default is on (highly recommended)

NOTE

Specific values for these parameters may be typed manually in the appropriate boxes on the "Acquisition" or "Pulse Sequence" panels.

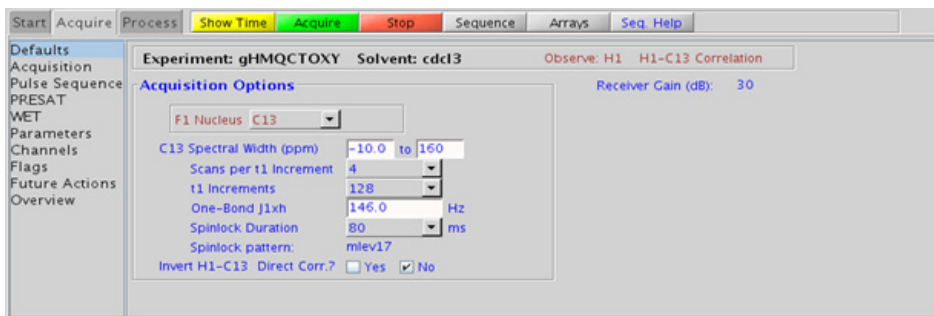

Processing

Automated processing is turned on by default, and the parameters are set to reasonable values, such that the resulting data after the acquisition usually require no further adjustment. The “Process” tab/“Basic” panel contains many of the commonly modified processing parameters, such as a pull-down menu to change the FT data size (1k x 1k is the default), as well as a check box to turn on/off linear prediction and a pull-down to control the extent of linear prediction (default is 4*ni). Menus to quickly change the weighting functions in F2/F1 are also present (defaults are gaussians); the parameters for the weighting functions are calculated automatically from the acquisition time and number of increments. More processing details are found under some of the other “Process” panels, such as the “Default”, “Weighting”, and “More 2D” panels.

Tips, tricks, and next steps

- Spectral width (sw) setting transfers from a PROTON if the gHMQCTOXY is set up from this experiment. Setup from a TOCSY-type or HMQC-type experiment transfers TOCSY- or HMQC-related parameters, respectively. Receiver gain (gain) is usually set to a high value (?30), unless the sample is extremely concentrated or ¹³C-labelled.

- To measure ^1H - ^{13}C (or ^1H -X) coupling constants, the carbon decoupling can be turned off by entering “nnn” in the Channel 2 “Dec On/Off” entry on the “Channels” panel or alternatively by typing dm='nnn' on the command line.
- The spinlock time (in addition to the magnitude of the coupling constants) ultimately controls how far along the spin system the correlations extend. Use spinlock durations exceeding 150ms with caution, as this can result in sample heating. The efficiency of the TOCSY transfer is directly proportional to the size of the coupling constants between the pairs of protons. To show primarily vicinal and geminal couplings, select a shorter spinlock time, for example, 30ms or less.
- The type of spinlock can be changed from mlev17 (for smaller molecules) to clean mlev17 (for larger molecules on the “Pulse Sequence” tab).
- The default number of steady state scans (ss) that are acquired before data acquisition to establish sample equilibrium is 32, which works for most samples. However, higher power carbon decoupling may cause some perturbations that may necessitate more ss scans to reach equilibrium. This value is changed on the “Acquisition” panel of the “Acquire” tab if necessary.
- The default parameters use a Grad-90-Grad steady state between scans, which helps cleanup un-relaxed magnetization. This can result in much cleaner spectra, especially when using shorter acquisition times (at) and relaxation delays (d1) (defaults are 0.15s and 1s, respectively).
- On the “Pulse Sequence” tab there is a pull-down menu to select in-phase, inverted, or suppressed XH direct correlations. There is a minor sensitivity loss with this feature, however the extra information is obtained with no additional cost in experiment time. When direct correlations suppression is chosen the ^{13}C decoupling can be turned off to place any residual direct correlations away from the true ^1H chemical shifts. This can allow the observation of ^1H - ^1H J-connectivity between protons with very close overlap.
- The gHMQCTOXY experiment, like all other heteronuclear TOCSYs, is an experiment with a lower sensitivity than the respective simple, single bond correlation experiment. This is because the magnetization generated during the initial HSQC stage is then distributed along the ^1H coupling network. Thus, a higher number of transients per increment are required unless the sample is very concentrated.

9 Hetero-TOCSY - (HC)HetToxys

Tips, tricks, and next steps

- In general, the HSQC-type experiments provide spectra with narrower peaks shapes (by suppressing ^1H - ^1H homonuclear coupling modulation in F1) than the HMQC-types, typically leading to better S/N and resolution.
- The HMQCTOXY experiment has a sensitivity advantage (factor of ~ 1.4) over the gHMQCTOXY, but may produce potentially less clean spectra (due to t_1 noise from strong signals such as t-butyl) than its gradient counterpart. The gradient enhanced version of these experiments can also suffer from additional sensitivity loss due to diffusion during the mixing time if the analyte is small and/or the solvent is non-viscous. Typically, consider using the non-gradient coherence selection version.

References:

- L. Lerner, A. Bax, J. Magn. Reson. 69 (1986) 375-380. (HMQC-TOCSY)
- R. E. Hurd, J. Magn. Reson. 87 (1990) 422-428. (Gradient based Coherence Selection)
- R. C. Crouch, T. D. Spitzer, G. E. Martin, Magn. Reson. Chem. 30 (1992) S71-S73. (Multiplicity Edited HMQC-TOCSY)



10 Carbon-carbon correlation - (CC)corr

(CC)corr Tab 370
INADEQUATE 372
INADEQUATEAD 376
ADEQUATEAD 380



(CC)corr Tab

This tab contains three experiments to map direct correlations from carbon to carbon. Two experiments are ^{13}C -detected (INADEQUATE and INADEQUATEAD) and the third is ^1H -detected (ADEQUATEAD). To unambiguously elucidate the structure of small-molecules, the INADEQUATE and INADEQUATE(AD) experiments have no peer except perhaps X-ray crystallography. They are, however, highly insensitive and thus infrequently used.

A good rule of thumb to determine if the sample is concentrated enough for this class of experiment to be successful within a reasonable time (overnight acquisition) is that the S/N for the CARBON spectrum is $\sim 25:1$ after a single scan. The proton-detected ADEQUATEAD experiment is more sensitive. However it has the requirement that a proton must be nearby for the carbon to be detected. The “AD” experiments include adiabatic carbon 180° pulses and are highly recommended, as they provide more uniform inversion profiles for a wide ^{13}C spectral width.

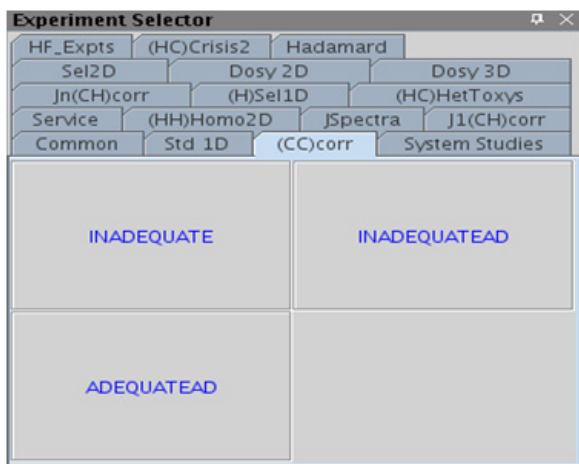

INADEQUATE

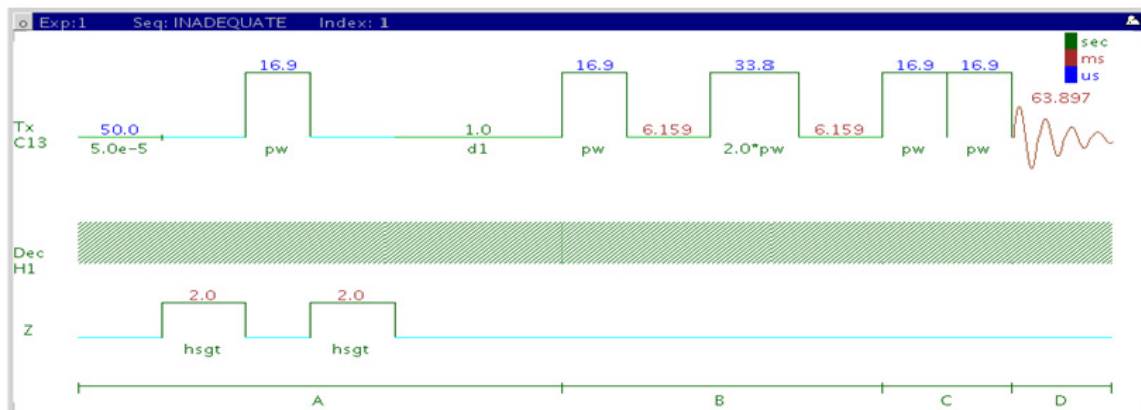

General description and usage

Description:

Two Dimensional homonuclear multiple-quantum J-correlation spectroscopy.

Usage:

The INADEQUATE experiment shows correlations between carbons that are directly coupled to one another. The data have great utility for structure elucidation as the carbon connectivities are established directly from the correlations. These connectivities can then be used to map the molecular framework, similar to x-ray crystallography. The drawback to the experiment is that as the sensitivity is very low; it should only be attempted with samples of higher concentrations. All parameters are set from the "Acquire" tab/"Defaults" panel unless otherwise specified.

Key parameters

Parameter	Description
C13 Spectral Width (sw)	Type in desired values in ppm
Acquisition time (at)	Set from "Pulse Sequence" panel, controls the resolution in F2, default 0.064s
Scans per t1 increment (nt)	Select typical choices from pull down menu*
t1 Increments (ni)	Select typical choices from pull down menu*- controls the resolution in F1
One-Bond C-C coupling Jcc (jcc)	Type in value for the average J_{C-C}^1 55 Hz works well for most molecules
Steady State (ss)	Set from "Pulse Sequence" panel, turn on/off gradient cleanup between scans

NOTE

You can type specific values for these parameters manually in the appropriate boxes on the "Acquisition" panel.

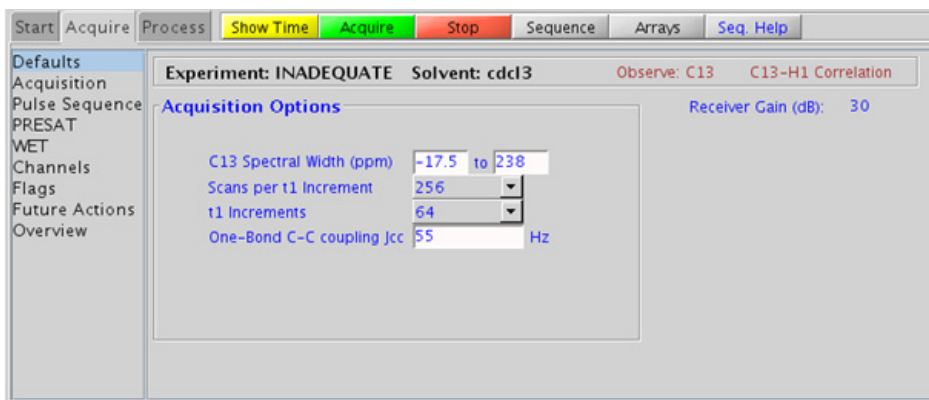

Processing

Automated processing is turned on by default, and the parameters are set to reasonable values, such that the resulting data after the acquisition usually require no further adjustment. The “Process” tab/“Basic” panel contains many of the commonly modified processing parameters, such as a pull-down menu to change the FT data size (2k x 2k is the default), as well as a check box to turn on/off linear prediction and a pull-down to control the extent of linear prediction (default is 2*ni). Menus to quickly change the weighting functions in F2/F1 are also present (defaults are gaussians); the parameters for the weighting functions are calculated automatically from the acquisition time and number of increments. More processing details are found under some of the other “Process” panels, such as the “Default”, “Weighting”, and “More 2D” panels.

Tips, tricks, and next steps

- Spectral width (sw) setting transfers from a CARBON if the INADEQUATE is set up from this experiment. Receiver gain (gain) is usually set to a high value (≥ 30).
- Spectral width in the F1 dimension (sw1) is set, by default, to $sw*2$. However, a value of $sw1=sw$ (while generating aliased peaks along F1) can be used with no ambiguities in connectivity interpretations.
- The default number of steady state scans (ss) that are acquired before data acquisition to establish sample equilibrium is 32, which works for most samples. This value is changed on the “Acquisition” panel of the “Acquire” tab if necessary.
- The default parameters use a Grad-90-Grad steady state between scans, which helps cleanup un-relaxed magnetization. This can result in much cleaner spectra, especially when using shorter acquisition times (at) and relaxation delays (d1) (defaults are 0.15s and 1s, respectively).
- Observing quaternary carbons is uniquely challenging. Use of some relaxation agent may be helpful while running the INADEQUATE experiment.
- A good rule of thumb to determine if the sample is concentrated enough for an INADEQUATE experiment is that the S/N for the CARBON spectrum is $\sim 25:1$ after a single scan.

- The INADEQUATEAD uses adiabatic 180° carbon pulses and often gives better results than the INADEQUATE, particularly when the carbon pulses are not perfectly calibrated for the given sample. In addition, the adiabatic 180° pulses provide a much more uniform inversion over a wide ¹³C spectral width.

References:

A. Bax, R. Freeman, S. P. Kempell, J. Am. Chem. Soc. 102 (1980) 4849-4851 (INADEQUATE)

J. Buddrus, J. Lambert, Magn. Reson. Chem. 40 (2002) 3-23.
(INADEQUATE – Recent Developments)

A. D. Bain D. W. Hughes, C. K. Anand, Z. Nie, V. J. Robertson, Magn. Reson. Chem. 48 (2010) 630-641 (INADEQUATE – Practical Aspects)

INADEQUATEAD

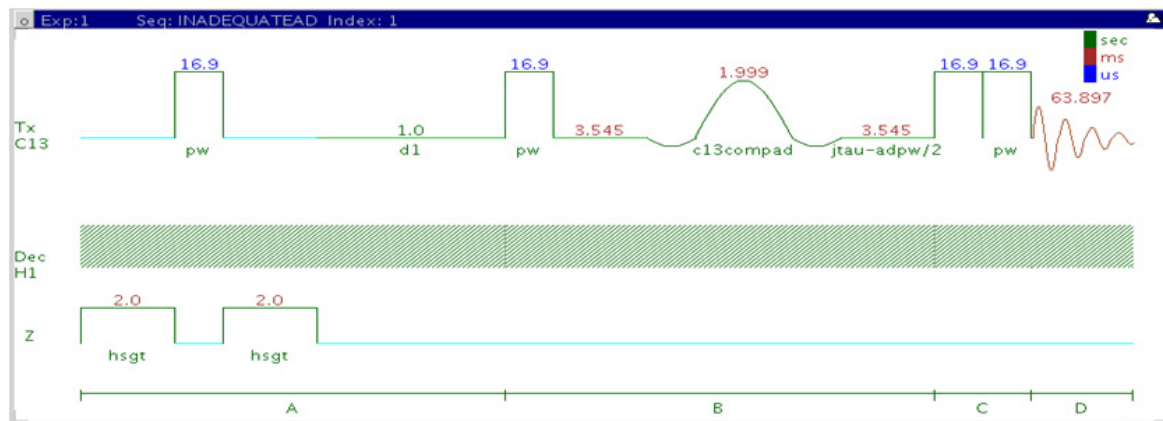

General description and usage

Description:

Two Dimensional homonuclear multiple-quantum J-correlation spectroscopy with adiabatic 180° X-nuclei pulses.

Usage:

The INADEQUATE experiment shows correlations between carbons that are directly coupled to one another. The data have great utility for structure elucidation, as the carbon connectivities are established directly from the correlations. These connectivities can then be used to map the molecular framework, similar to x-ray crystallography. The drawback to the experiment is that as the sensitivity is very low; it should only be attempted with samples of higher concentrations. All parameters are set from the "Acquire" tab/"Defaults" panel unless otherwise specified.

Key parameters

Parameter	Description
C13 Spectral Width (sw)	Type in desired values in ppm
Acquisition time (at)	Set from "Pulse Sequence" panel, controls the resolution in F2, default 0.064s
Scans per t1 increment (nt)	Select typical choices from pull down menu*
t1 Increments (ni)	Select typical choices from pull down menu*- controls the resolution in F1
One-Bond C-C coupling Jcc (jcc)	Type in value for the average J_{C-C}^1 55 Hz works well for most molecules
Steady State (ss)	Set from "Pulse Sequence" panel, turn on/off gradient cleanup between scans

NOTE

Specific values for these parameters may be typed manually in the appropriate boxes on the "Acquisition" panel.

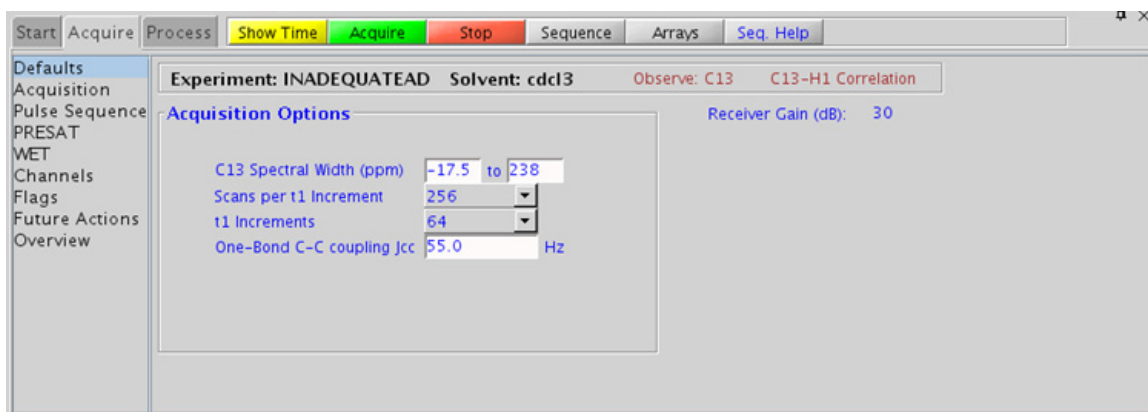

Processing

Automated processing is turned on by default, and the parameters are set to reasonable values, such that the resulting data after the acquisition usually require no further adjustment. The “Process” tab/“Basic” panel contains many of the commonly modified processing parameters, such as a pull-down menu to change the FT data size (2k x 2k is the default), as well as a check box to turn on/off linear prediction and a pull-down to control the extent of linear prediction (default is 2*ni). Menus to quickly change the weighting functions in F2/F1 are also present (defaults are gaussians); the parameters for the weighting functions are calculated automatically from the acquisition time and number of increments. More processing details are found under some of the other “Process” panels, such as the “Default”, “Weighting”, and “More 2D” panels.

Tips, tricks, and next steps

- Spectral width (sw) setting transfers from a CARBON if the INADEQUATEAD is set up from this experiment. Receiver gain (gain) is usually set to a high value (≥ 30).
- Spectral width in the F1 dimension (sw1) is set, by default, to $sw*2$. However, a value of $sw1=sw$ (while generating aliased peaks along F1) can be used with no ambiguities in connectivity interpretations.
- The default number of steady state scans (ss) that are acquired before data acquisition to establish sample equilibrium is 32, which works for most samples. This value is changed on the “Acquisition” panel of the “Acquire” tab if necessary.
- The default parameters use a Grad-90-Grad steady state between scans, which helps cleanup un-relaxed magnetization. This can result in much cleaner spectra, especially when using shorter acquisition times (at) and relaxation delays (d1) (defaults are 0.15s and 1s, respectively).
- Observing quaternary carbons is uniquely challenging. Use of some relaxation agent may be helpful while running the INADEQUATEAD experiment.

- A good rule of thumb to determine if the sample is concentrated enough for an INADEQUATEAD experiment to be successful within a reasonable time (overnight acquisition) is that the S/N for the CARBON spectrum is ~25:1 after a single scan.
- The INADEQUATEAD uses adiabatic 180° carbon pulses and often gives better results than the INADEQUATE, particularly when the carbon pulses are not perfectly calibrated for the given sample. In addition, the adiabatic 180° pulses provide a much more uniform inversion over a wide ¹³C spectral width.

References:

A. Bax, R. Freeman, S. P. Kempsell, J. Am. Chem. Soc. 102 (1980) 4849-4851 (INADEQUATE)

L. Jin, D. Uhrin, Magn. Reson. Chem. 45 (2007) 628-633 (IPAP INADEQUATE with Adiabatic Pulses)

D. Uhrin, Ann. Rep. NMR. Spectrosc. 70 (2010) 1-34 (INADEQUATE – Review)

ADEQUATEAD

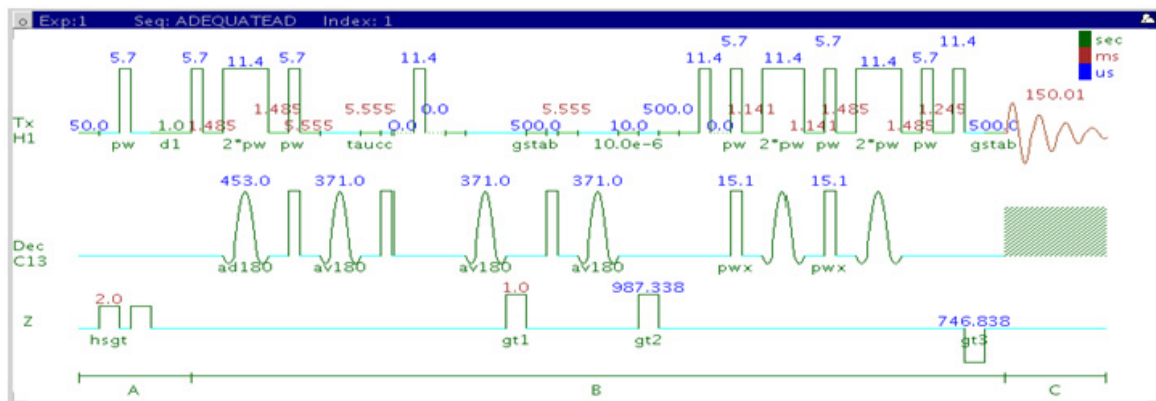

General description and usage

Description:

Two Dimensional heteronuclear single or double-quantum J-correlation spectroscopy with adiabatic 180° X-nuclei pulses.

Usage:

The ADEQUATEAD experiment can be acquired either as a single quantum experiment or a double quantum experiment. The single quantum experiment selectively transfers coherences from two adjacent carbons to protons directly attached to one of the carbons. The double quantum experiment can connect carbons that are separated by multiple bonds. The data have great utility for structure elucidation, as the carbon connectivities established indirectly from the correlations can then be used to map the molecular framework. The experiment is more sensitive (theoretically a factor of 32) than the INADEQUATEAD. However, the ADEQUATEAD experiment relies on at least one nearby attached proton,

so correlations between quaternary carbons are not observed. All parameters are set from the “Acquire” tab/”Defaults” panel unless otherwise specified.

Key parameters

Parameter	Description
Spectral Width (sw)	Set from previously acquired PROTON*
Acquisition time (at)	Set from “Pulse Sequence” panel, controls the resolution in F2, default 0.15s
F1 Nucleus (dn)	Pull- down menu to set F1 nucleus to ^{13}C , ^{15}N , or other*
C13 Spectral Width (ppm)	Type in desired chemical shift range for F1 dimension
Scans per t1 increment (nt)	Select typical choices from pull down menu*
t1 Increments (ni)	Select typical choices from pull down menu*- controls the resolution in F1 (minimum ~64)
One-Bond J1xh (j1xh)	Type in value for the average $^1J_{\text{C,H}}$ - 146 Hz works well for most molecules
C-C evolution	Set to single quantum (SQ) or double quantum (DQ)
Steady State (ss)	Set from “Pulse Sequence” panel, turn on/off gradient cleanup between scans

NOTE

Specific values for these parameters may be typed manually in the appropriate boxes on the “Acquisition” or “Pulse Sequence” panels.

10 Carbon-carbon correlation - (CC)corr Processing

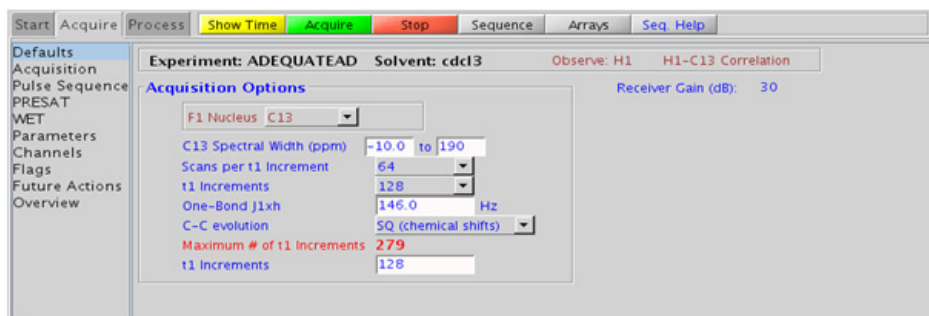

Processing

Automated processing is turned on by default, and the parameters are set to reasonable values, such that the resulting data after the acquisition usually require no further adjustment. The “Process” tab/“Basic” panel contains many of the commonly modified processing parameters, such as a pull-down menu to change the FT data size (1k x 1k is the default), as well as a check box to turn on/off linear prediction and a pull-down to control the extent of linear prediction (default is 4*ni). Menus to quickly change the weighting functions in F2/F1 are also present (defaults are gaussians); the parameters for the weighting functions are calculated automatically from the acquisition time and number of increments. More processing details are found under some of the other “Process” panels, such as the “Default”, “Weighting”, and “More 2D” panels.

Tips, tricks, and next steps

- Spectral width (sw) setting transfers from a PROTON if the ADEQUATEAD is set up from this experiment. Receiver gain (gain) is usually set to a high value (≥ 30).

- The default number of steady state scans (ss) that are acquired before data acquisition to establish sample equilibrium is 32, which works for most samples. This value is changed on the “Acquisition” panel of the “Acquire” tab if necessary.
- The default parameters use a Grad-90-Grad steady state between scans, which helps cleanup un-relaxed magnetization. This can result in much cleaner spectra, especially when using shorter acquisition times (at) and relaxation delays (d1) (defaults are 0.15s and 1s, respectively).

References:

B. Reif, M. Kock, R. Kerssebaum, H. Kang, W. Fenical, C. Griesinger, J. Magn. Reson. A118 (1996) 282-285 (ADEQUATE)

M. Kock, R. Kerssebaum, W. Bermel, Magn. Reson. Chem. 41 (2003) 65-69. (ADEQUATE with Adiabatic Pulses)

T. Parella, F. S. Ferrando, J. Magn. Reson, 166 (2004) 123-128. (ADEQUATE with Multiplicity Editing)

10 Carbon-carbon correlation - (CC)corr
Tips, tricks, and next steps



11 Proton-fluorine - HF_Expts

HF_Expts Tab	386
FH_gHETCOR	388
FH_HOESY	392
FObs_HDec	396
HObs_FDec	400



HF_Expts Tab

This tab of the experiment selector includes both 1D and 2D experiments involving ^1H and ^{19}F . All the experiments are designed such that the data are acquired without the need for a second high-band channel in the spectrometer. The 1D experiments are with fluorine observe, proton decouple (FObs_HDec), and *vice versa* (HObs_FDec). The 2D experiments available include both J-coupling (FH_gHETCOR) and through-space (FH_HOESY) correlation experiments.

These experiments can provide a unique handle for structure elucidation and peak assignment of fluorinated compounds. When acquiring impure samples of fluorinated compounds from a biological origin, these experiments can be used to see resonances from the molecule of interest, while excluding background signals. These experiments require a probe that can be simultaneously tuned to H and F and has the appropriate H-F calibrations in the probe file. There are unique calibration routines in the channel sharing mode. See to the VnmrJ Installation and Administration manual, Chapter 9, for information on calibration.

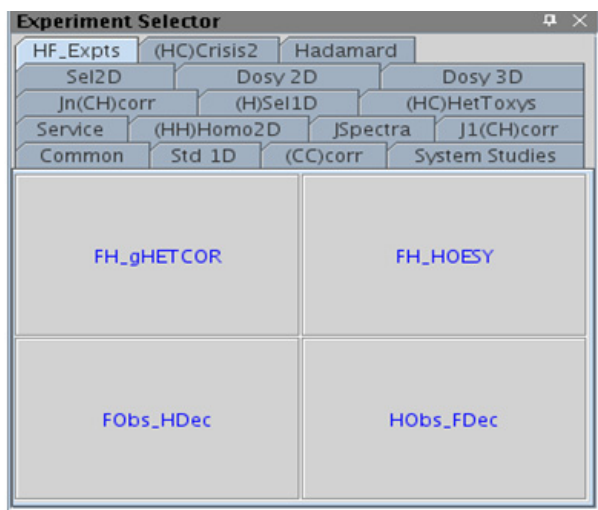

FH_gHETCOR

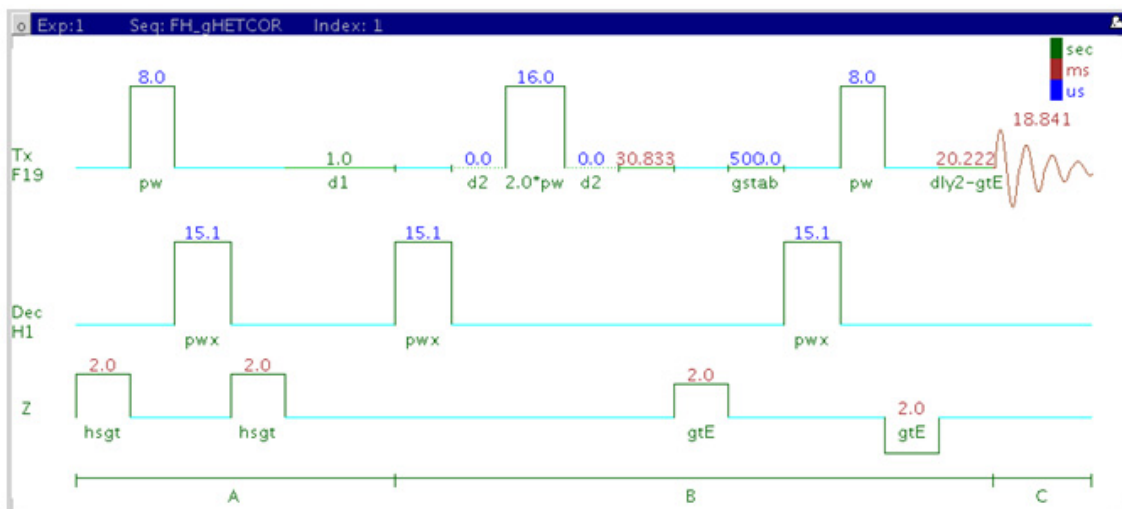

General description and usage

Description:

Two Dimensional heteronuclear ^1H - ^{19}F shift correlation with fluorine observe and gradient coherence selection.

Usage:

The FH_gHETCOR experiment is used to acquire a 2-dimensional spectrum to correlate protons coupled to fluorines with fluorine detection, meaning the F1 dimension is ^1H and the F2 dimension is ^{19}F . This scheme allows for higher resolution in the fluorine dimension as the chemical shift range is much larger. This experiment is useful to confirm the attachment location(s) for fluorine atom(s) in a molecule. All parameters are set from the "Acquire" tab/"Defaults" panel unless otherwise specified.

Key parameters

Parameters	Description
Spectral Width (sw)	Set from previously acquired FLUORINE or Fobs_HDec*
Acquisition time (at)	Set from "Pulse Sequence" panel, controls the resolution in F2, default 0.019 s
H1 Spectral Width [ppm] [F1]	Select typical choices from pull down menu or type in values
Scans per t1 increment (nt)	Select typical choices from pull down menu*
t1 Increments (ni)	Select typical choices from pull down menu* - controls the resolution in F1
F-H Coupling Constant (jFH)	Set value for the average $^nJ_{F,H}$
Steady State (ss)	Set from "Pulse Sequence" panel, turn on/off gradient cleanup between scans

NOTE

Specific values for these parameters may be typed manually in the appropriate boxes on the "Acquisition" or "Pulse Sequence" panels.

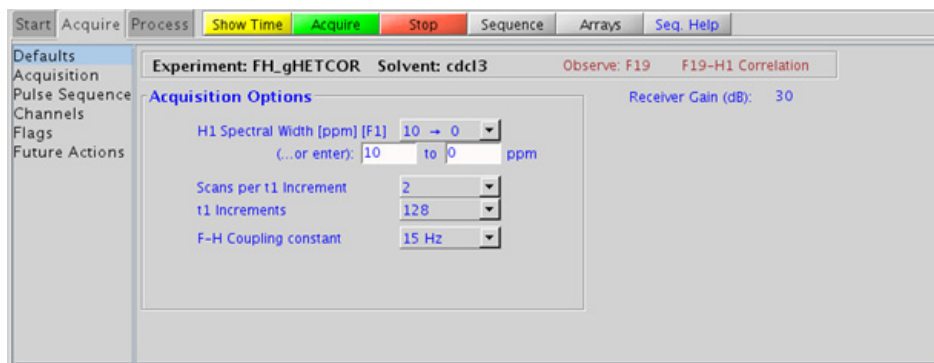

Processing

Automated processing is turned on by default, and the parameters are set to reasonable values, such that the resulting data after the acquisition usually require no further adjustment. The “Process” tab/“Basic” panel contains many of the commonly modified processing parameters, such as a pull-down menu to change the FT data size (2k x 1k is the default), as well as a check box to turn on/off linear prediction and a pull-down to control the extent of linear prediction (default is 4*ni). Menus to quickly change the weighting functions in F2/F1 are also present (defaults are gaussians); the parameters for the weighting functions are calculated automatically from the acquisition time and number of increments. More processing details are found under some of the other “Process” panels, such as the “Default”, “Weighting”, and “More 2D” panels.

Tips, tricks, and next steps

- Note: this experiment requires a probe that can be simultaneously tuned to H and F and has the appropriate H-F calibrations in the probe file.
- Spectral width (sw) and receiver gain (gain) settings transfer from a FLUORINE or FObs_HDec data set if the FH_gHETCOR is set up from these experiments. As ^{19}F has a large chemical shift range, it is highly recommended that the sw is optimized before acquiring this experiment. Using the Fobs_HDec experiment for setup preserves the decoupling parameters. However, decoupling may result in sensitivity losses and unintended signal cancellations. Decoupling can be turned off by setting the parameter dm to the value “nnn”.
- The default number of steady state scans (ss) that are acquired before data acquisition to establish sample equilibrium is 32, which works for most samples. This value is changed on the “Acquisition” panel of the “Acquire” tab if necessary.
- The default parameters use a Grad-90-Grad steady state between scans, which helps cleanup un-relaxed magnetization. The default setting for this parameter is off.

References:

J. Battiste, R. A. Newmark, Prog. NMR. Spectrosc. 48 (2006) 1-23.
(Multidimensional ^{19}F NMR)

FH_HOESY

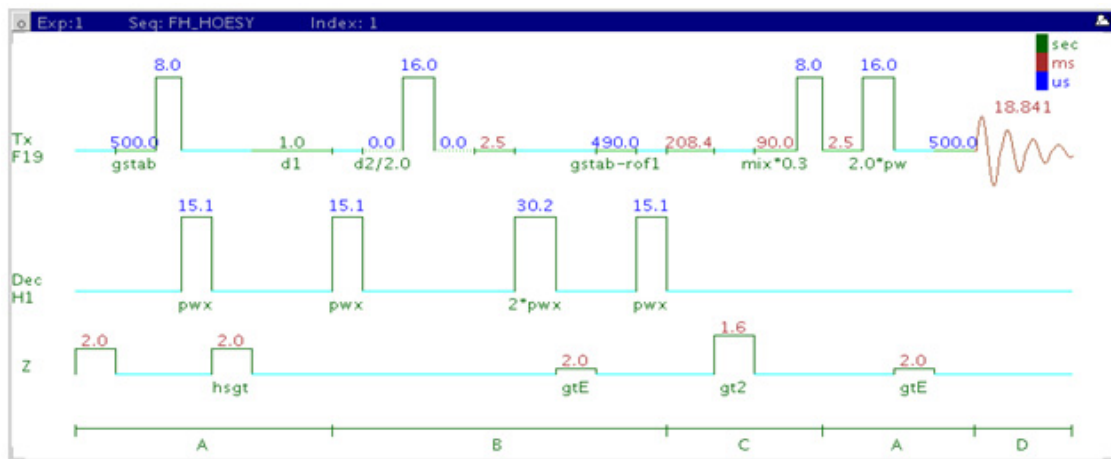

General description and usage

Description:

Two Dimensional heteronuclear ^1H - ^{19}F through-space correlation spectroscopy with fluorine observe.

Usage:

The FH_HOESY experiment produces a 2-dimensional spectrum with crosspeaks between fluorines and protons that are close in space (typically $<5 \text{ \AA}$). The experiment is configured with fluorine detection, meaning the F1 dimension is ^1H and the F2 dimension is ^{19}F . This scheme allows for higher resolution in the fluorine dimension as the chemical shift range is much larger. The FH_HOESY experiment is often used to help determine stereochemistry for rigid ring systems or to confirm attachment locations for fluorines on unsaturated carbons (for example, aromatic) of a molecule. All parameters are set from the "Acquire" tab/"Defaults" panel unless otherwise specified.

Key parameters

Parameter	Description
Spectral Width (sw)	Set from previously acquired FLUORINE or Fobs_HDec*
Acquisition time (at)	Set from "Pulse Sequence" panel, controls the resolution in F2, default 0.019 s
Scans per increment (nt)	Select typical choices from pull down menu*
Number of increments (ni)	Select typical choices from pull down menu*- controls the resolution in F1 (minimum ~64)
H1 Spectral Width [ppm] [F1]	Select typical choices from pull down menu or type in values
HOESY mixing time (mix)	Select from pull down menu*
Make coherence selection with gradient	Check box to turn gradient coherence selection on/off
Steady State (ss)	Set from "Pulse Sequence" panel, turn on/off gradient cleanup between scans
Relaxation time (d1)	Set from "Acquisition" panel controls the delay between scans

NOTE

Specific values for these parameters may be typed manually in the appropriate boxes on the "Acquisition" or "Pulse Sequence" panels.

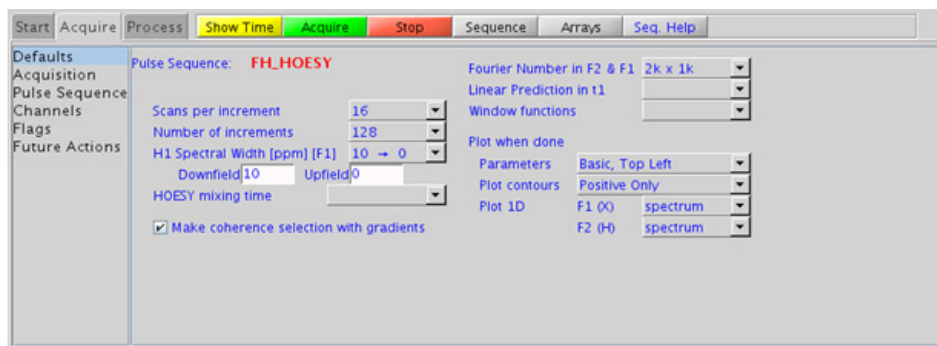

Processing

Automated processing is turned on by default, and the parameters are set to reasonable values, such that the resulting data after the acquisition usually require no further adjustment, except for minor manual phasing changes that may be required, as the NOE peaks are negative for smaller molecules. The “Process” tab/“Basic” panel contains many of the commonly modified processing parameters, such as a pull-down menu to change the FT data size (2k x 1k is the default), as well as a check box to turn on/off linear prediction and a pull-down to control the extent of linear prediction (default is 2*ni). Menus to quickly change the weighting functions in F2/F1 are also present (defaults are gaussians); the parameters for the weighting functions are calculated automatically from the acquisition time and number of increments. More processing details are found under some of the other “Process” panels, such as the “Default”, “Weighting”, and “More 2D” panels.

Tips, tricks, and next steps

- Note: this experiment requires a probe that can be simultaneously tuned to H and F and has the appropriate H-F calibrations in the probe file.
- Spectral width (sw) and receiver gain (gain) settings transfer from a FLUORINE or FObs_HDec data set if the FH_gHETCOR is set up from these experiments. As ^{19}F has a large chemical shift range, it is highly recommended that the sw is optimized before acquiring this experiment. Using the Fobs_HDec experiment for setup preserves the decoupling parameters. However, decoupling may result in sensitivity losses. Decoupling can be turned off by setting the parameter dm to the value “nnn”.
- The default number of “steady state” or “dummy scans” that are acquired before data acquisition to establish sample equilibrium is 32, which works for most samples. This value is changed on the “Acquisition” panel of the “Acquire” tab if necessary.
- The default parameters use a Grad-90-Grad steady state between scans, which helps cleanup un-relaxed magnetization. This can result in much cleaner spectra, especially when using shorter acquisition times and d1 relaxation delays (defaults are 0.15s and 1s, respectively).

References:

J. Battiste, R. A. Newmark, Prog. NMR. Spectrosc. 48 (2006) 1-23.
(Multidimensional ^{19}F NMR)

W. Bauer, Magn. Reson. Chem. 34 (1996) 532-537. (Gradient Inverse
HOESY)

FObs_HDec

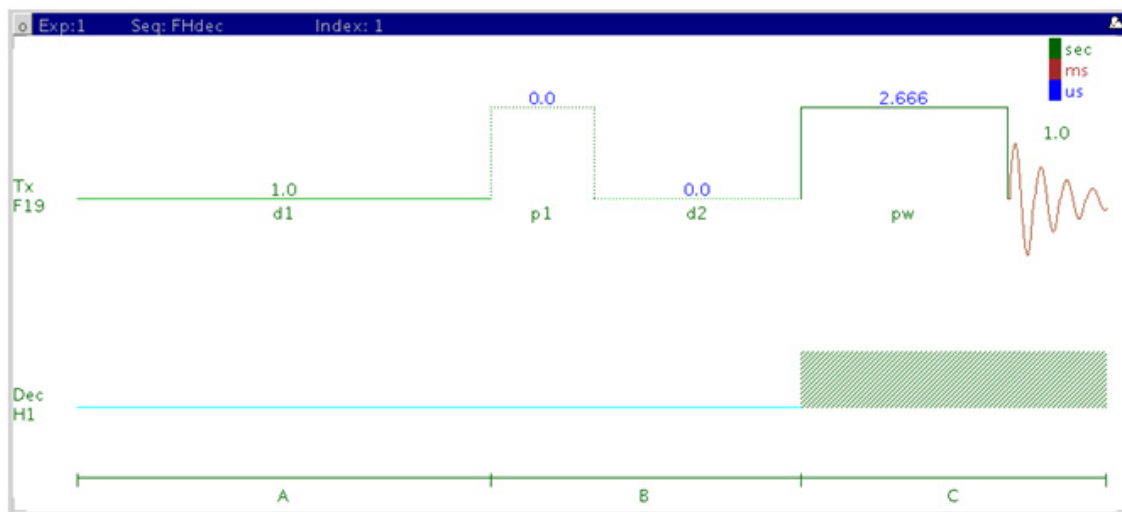

General description and usage

Description:

Uses the standard s2pul pulse sequence to acquire a 1D- ^{19}F dataset with proton decoupling.

Usage:

The FObs_HDec experiment is typically used to confirm the presence of fluorine in a molecule. The large fluorine chemical shift range is highly sensitive to nearby functional groups. The experiment is nearly as sensitive as a 1D PROTON experiment, and the decoupling increases the sensitivity by collapsing the ^{19}F peaks into singlets. All parameters are set from the “Acquire” tab/”Default F19” panel unless otherwise specified.

Key parameters

Parameter	Description
Solvent (solvent)	Set from the "Start" tab/"Standard" panel
Spectral Width (sw)	Type in specific ppm values
Number of scans (nt)	Select typical choices from pull down menu*
Relaxation Delay (d1)	Select typical choices from pull down menu*-controls the delay between scans
Pulse Angle	Select typical choices from pull down menu*-controls the tip angle for the pulse
H1 Decoupler offset (dof)	Type in value for the center of the proton chemical shift range to optimize decoupling
Acquisition time (at)	Set from "Pulse Sequence" panel, controls the digital resolution (Hz/point, 1/at)

NOTE

Specific values for these parameters may be typed manually in the appropriate boxes on the "Acquisition" panel.

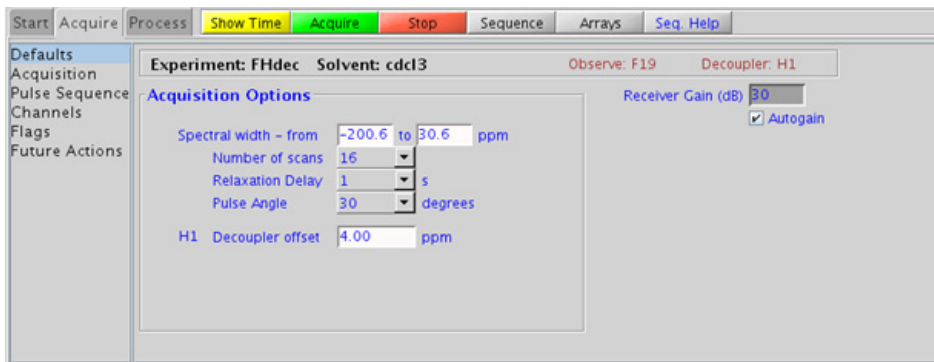

Processing

A typical processing apodization choice which provides S/N enhancement (at the expense of resolution) for a 1D spectrum is line broadening, with an lb setting from ~ 0.5 -1 Hz. A suggested optimal value is an lb equal to the peak linewidth at half-height. Other types of apodization are available under the “Process” tab on the “Weighting” panel. Suggested choices for resolution enhancement (at the expense of S/N) are “pseudo echo” and “res-enhance.” When the weighting function is selected, values for these parameters are calculated based on the acquisition time. They may also be set manually with the “Interactive Weighting” button.

CAUTION

Resolution enhancing functions affect the spectral integration- do not use these types of apodization for quantification.

Many NMR probes contain fluorinated materials, which cause broad signals that can distort the baseline (especially when lying next to or outside the spectral window). The default processing parameters are set to use linear prediction to back predict the first seven points of the spectrum in order to flatten the baseline. These settings may be modified under the “Process” tab on the “More 1D” panel.

Tips, tricks, and next steps

- Note: this experiment requires a probe that can be simultaneously tuned to H and F and has the appropriate H-F calibrations in the probe file.
- This fluorine experiment produces a proton-decoupled ^{19}F spectrum. See the FLUORINE experiment (Chapter 2) for a proton-decoupled version of the experiment, or set the parameter dm to the value ‘nnn’. Parameters to optimize the decoupling are found on the “Pulse Sequence” tab. However, as the proton chemical shift range is quite small, the default parameters should usually work well (default shape covers an 8000 Hz range).

- To further optimize the spectral width (sw), place one cursor on each side of the desired region on the spectrum, click the  button located under the spectrum window and reacquire the data. The default range is set to cover the typical range of fluorine chemical shifts seen in organic molecules. As this range is very large, once the fluorine signals are located, consider narrowing the chemical shift range and reacquiring the spectrum for better resolution.
- The acquisition time, which controls the digital resolution (Hz/point, which is equal to $1/at$), is set on the “Acquisition” page of the “Acquire” tab. Because FLUORINE spectra are often acquired with large spectral widths, the default digital resolution (set from the chosen spectral width) may be insufficient to see small couplings; consider lengthening the acquisition time and/or narrowing the spectral width.
- It must be noted that the total interscan delay is the sum of the acquisition time (at) and the relaxation delay (d1). When acquiring a multi-scan FObs_HDec experiment for quantification, set the interscan delay to at least 5X the longest fluorine T1 value in the molecule.
- When acquiring impure samples of fluorinated compounds from a biological origin, consider using fluorine spectra in lieu of a more complicated proton spectrum as appropriate.

HObs_FDec

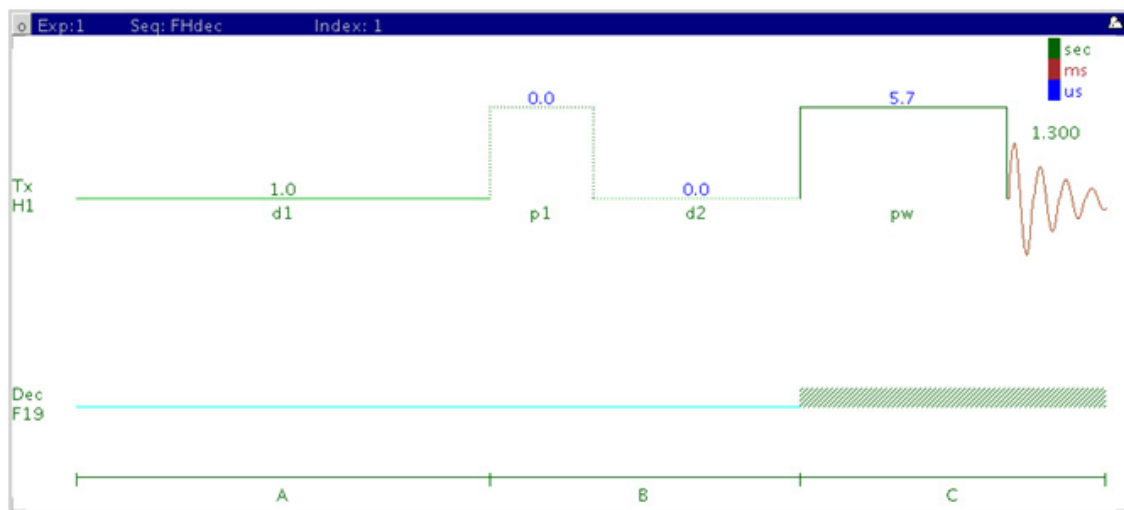

General description and usage

Description:

Uses the standard s2pul pulse sequence to acquire a 1D-¹H dataset with ¹⁹F decoupling.

Usage:

The HObs_FDec experiment can be used to simplify proton spectra with complicated fluorine coupling and to establish which protons are coupled to fluorine. All parameters are set from the “Acquire” tab/”Default F19” panel unless otherwise specified.

Key parameters

Parameter	Description
Solvent (solvent)	Set from the "Start" tab/"Standard" panel
Spectral Width (sw)	Type in specific ppm values
Number of scans (nt)	Select typical choices from pull down menu*
Relaxation Delay (d1)	Select typical choices from pull down menu*-controls the delay between scans
Pulse Angle	Select typical choices from pull down menu*-controls the tip angle for the pulse
F19 Decoupler offset (dof)	Type in value for the center of the fluorine chemical shift range to optimize decoupling
Acquisition time (at)	Set from "Pulse Sequence" panel, controls the digital resolution (Hz/point, 1/at)

NOTE

Specific values for these parameters may be typed manually in the appropriate boxes on the "Acquisition" panel.

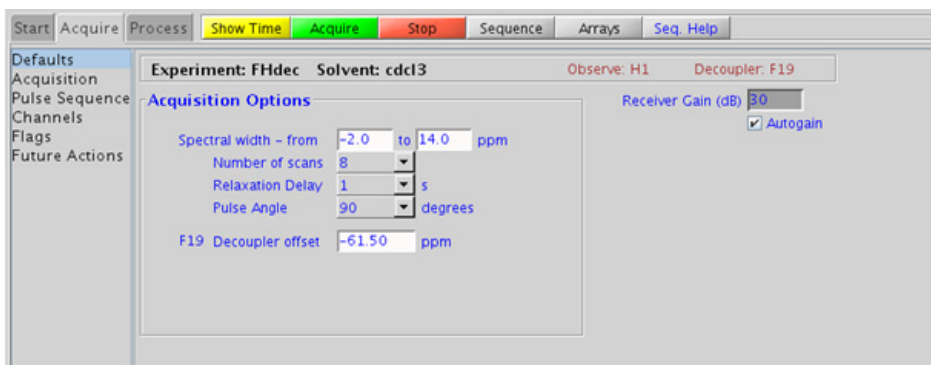

Processing

A typical processing apodization choice which provides S/N enhancement (at the expense of resolution) for a 1D spectrum is line broadening, with an lb setting from ~ 0.5 -1 Hz. A suggested optimal value is an lb equal to the peak linewidth at half-height. Other types of apodization are available under the “Process” tab on the “Weighting” panel. Suggested choices for resolution enhancement (at the expense of S/N) are “pseudo echo” and “res-enhance.” When the weighting function is selected, values for these parameters are calculated based on the acquisition time. They may also be set manually with the “Interactive Weighting” button.

CAUTION

Resolution enhancing functions affect the spectral integration- do not use these types of apodization for quantification.

Tips, tricks, and next steps

- Note: this experiment requires a probe that can be simultaneously tuned to H and F and has the appropriate H-F calibrations in the probe file.
- The HObs_FDec experiment produces a fluorine-decoupled ^1H spectrum. See the PROTON experiment (Chapter 2) for a proton-decoupled version of the experiment, or set the parameter dm to the value ‘nnn’. Parameters to optimize the decoupling are found on the “Pulse Sequence” tab. As the fluorine chemical shift range is quite large, it is important to locate the chemical shift(s) of the fluorine(s) for decoupling and set the decoupler offset properly. If there are multiple fluorines in the molecule with large chemical shift differences, consider decoupling a single fluorine at a time. Alternatively, an adiabatic decoupling shape may be created. See the VnmrJ manual for instructions on using Pbox.

- To further optimize the spectral width (sw), place one cursor on each side of the desired region on the spectrum, click the  button located under the spectrum window and reacquire the data. The default range is set to cover the typical range of fluorine chemical shifts seen in organic molecules. As this range is very large, once the fluorine signals are located, consider narrowing the chemical shift range and reacquiring the spectrum for better resolution.
- ^{19}F shaped decoupling (due to large chemical shift range of ^{19}F) typically necessitates higher powers to be used. However decoupling powers above 46 dB are not allowed in the shared mode (thus providing an instrument safety margin). Using the default parameters, the sensitivity of these decoupled experiments is approximately 60% that of the non-decoupled experiment. In case you want to change the decoupling bandwidths (for wider ^{19}F decoupling width) and/or duty cycle (to gain sensitivity and/or lower decoupling power) the decoupling shape must be recreated via the Pulse sequence panel.

11 Proton-fluorine - HF_Expts
Tips, tricks, and next steps



12 JSpectra

JSpectra Tab 406

HETERO2DJ 408

HOMO2DJ 412



JSpectra Tab

This tab of the experiment selector includes two experiments that provide information regarding coupling constants (J 's) in the F1 dimension. The HOMO2DJ experiment has proton chemical shifts in F2 and proton coupling constants in F1, while HETERO2DJ version has carbon chemical shifts in F2 and proton coupling constants in F1. As HETERO2DJ is carbon-detected, it is a very low sensitivity experiment.

These experiments are usually used to resolve complex, overlapping multiplets. The HOMO2DJ is also used to help resolve complicated, multi-component samples, such as from a biological matrix. In addition, with appropriate post-acquisition processing, the F2 projection in HOMO2DJ can be interpreted as a broadband homonuclear decoupled ^1H spectrum.

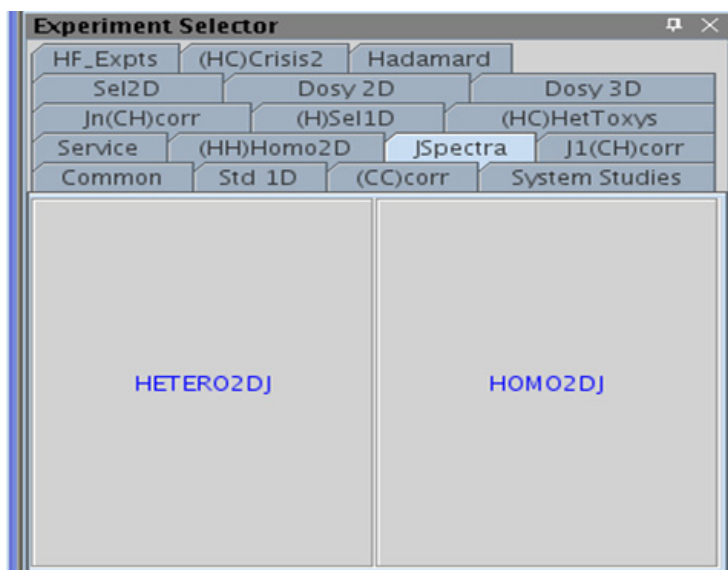

HETERO2DJ

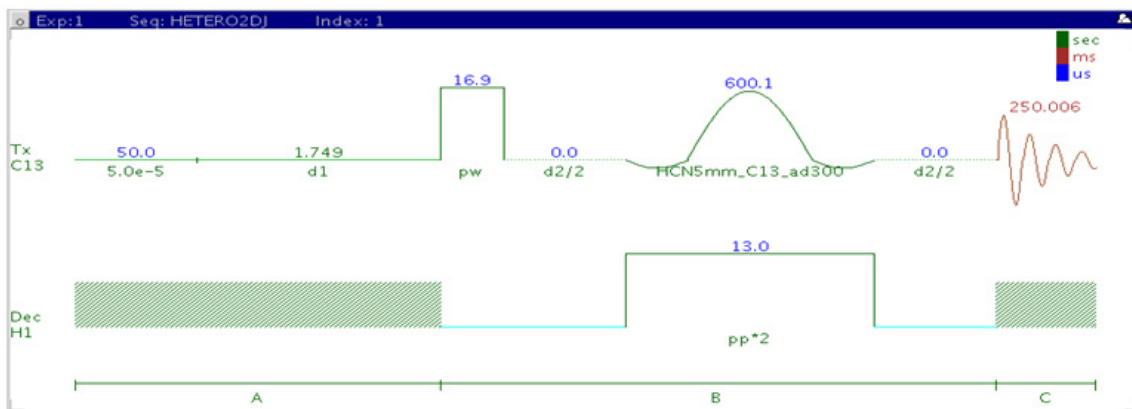

General description and usage

Description:

Two Dimensional heteronuclear J-resolved spectroscopy.

Usage:

The HETERO2DJ experiment is used to acquire a 2-dimensional spectrum with the ^{13}C chemical shifts in the F2 dimension and the ^1H couplings in F1. The experiment is fairly insensitive as it is carbon-detected.

Proton-carbon coupling constants are often used to help define *e/z* stereochemistry of double bonds or molecular conformations, for example, the torsion angles of peptides. All parameters are set from the “Acquire” tab/”Defaults” panel unless otherwise specified.

Key parameters

Parameter	Description
Spectral Width (sw)	Set from previously acquired CARBON*
Acquisition time (at)	Set from "Pulse Sequence" panel, controls the resolution in F2, default 0.25s
Scans per t1 increment (nt)	Select typical choices from pull down menu*
t1 Increments (ni)	Select typical choices from pull down menu*- controls the resolution in F1
F1 spectral width	Set value for the average range of $^1J_{C,H}$
Steady State (ss)	Set from "Pulse Sequence" panel, turn on/off gradient cleanup between scans

NOTE

Specific values for these parameters may be typed manually in the appropriate boxes on the "Acquisition" panel.

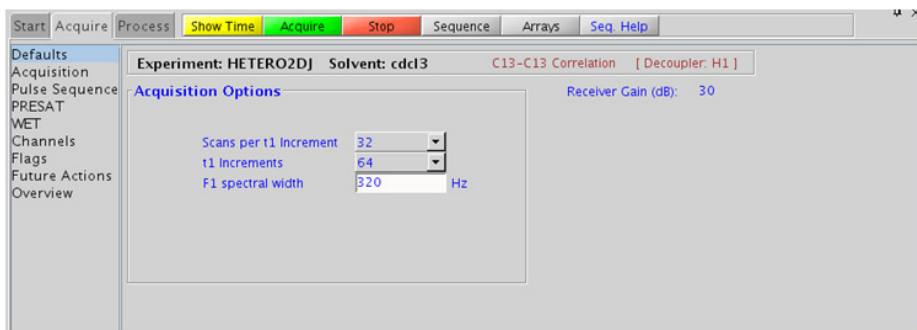

Processing

Automated processing is turned on by default, and the parameters are set to reasonable values, such that the resulting data after the acquisition usually require no further adjustment. The “Process” tab/“Basic” panel contains many of the commonly modified processing parameters, such as a pull-down menu to change the FT data size (8k x 128 is the default), as well as a check box to turn on/off linear prediction and a pull-down to control the extent of linear prediction (default is off). Menus to quickly change the weighting functions in F2/F1 are also present; the parameters for the weighting functions are calculated automatically from the acquisition time and number of increments. It is important to note that this experiment employs mix-mode processing, with the F2 dimension absolute value and F1 phase-sensitive. This arrangement allows for the best resolution and sensitivity combination. As such, the optimal weighting functions are the defaults of a squared shifted sinebell for F2 and gaussian for F1. More processing details are found under some of the other “Process” panels, such as the “Default”, “Weighting”, and “More 2D” panels.

Tips, tricks, and next steps

- Spectral width (sw) setting transfers from a CARBON if the HETERO2DJ is set up from this experiment. Receiver gain (gain) is usually set to a high value (≥ 30), unless the sample is extremely concentrated or ^{13}C -labelled.
- A typical value for sw1 of at least 3 times the largest expected one-bond coupling constant can avoid any potential folding of methyl quartets.
- The default number of steady state scans (ss) that are acquired before data acquisition to establish sample equilibrium is 32, which works for most samples. This value is changed on the “Acquisition” panel of the “Acquire” tab if necessary.
- The default parameters use a Grad-90-Grad steady state between scans, which helps cleanup un-relaxed magnetization. The default setting for this parameter is off.

- The (HC)EXSIDE experiment (see Chapter 7) can also be used to measure selective long-range H-C coupling constants and may provide better sensitivity, particularly when there are only one or two specific couplings of interest.

References:

W. P. Aue, J. Karhan, R. R. Ernst, J. Chem. Phys. 64 (1976) 4226-4227.
(COSY)

L. Muller, A. Kumar, R. R. Ernst, J. Magn. Reson. 25 (1977) 383-390. (2DJ)

G. Bodenhausen, G. A. Morris, R. Freeman, D. L. Turner, J. Magn. Reson. 28 (1977) 17-28. (2DJ)

HOM02DJ

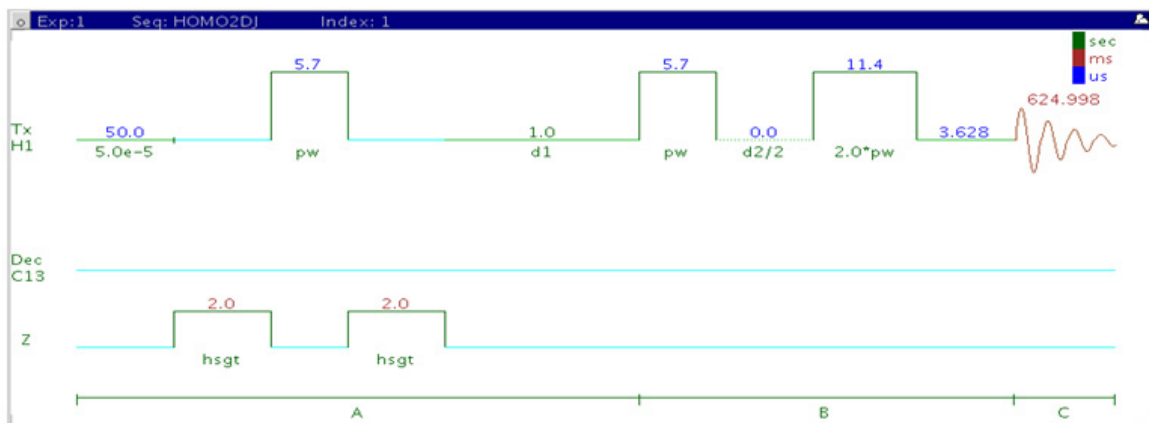

General description and usage

Description:

Two Dimensional homonuclear J-resolved spectroscopy.

Usage:

The HOM02DJ experiment is used to acquire a 2-dimensional spectrum with the ^1H chemical shifts in the F2 dimension and the ^1H couplings in F1. This experiment can be used to obtain accurate measurements of couplings when there are complex multiplets and/or overlap in the 1D PROTON spectrum. This experiment can also be used to help resolve overlap in complex multi-component spectra, such as spectra of biofluids. All parameters are set from the "Acquire" tab/"Defaults" panel unless otherwise specified.

Key parameters

Parameter	Description
Spectral Width (sw)	Set from previously acquired PROTON*
Acquisition time (at)	Set from "Pulse Sequence" panel, controls the resolution in F2, default 0.625s
Scans per t1 increment (nt)	Select typical choices from pull down menu*
t1 Increments (ni)	Select typical choices from pull down menu*- controls the resolution in F1
F1 spectral width	Set value for the average range of $^1J_{H,H}$ – don't forget couplings constants are both positive and negative
Steady State (ss)	Set from "Pulse Sequence" panel, turn on/off gradient cleanup between scans

NOTE

Specific values for these parameters may be typed manually in the appropriate boxes on the "Acquisition" panel.

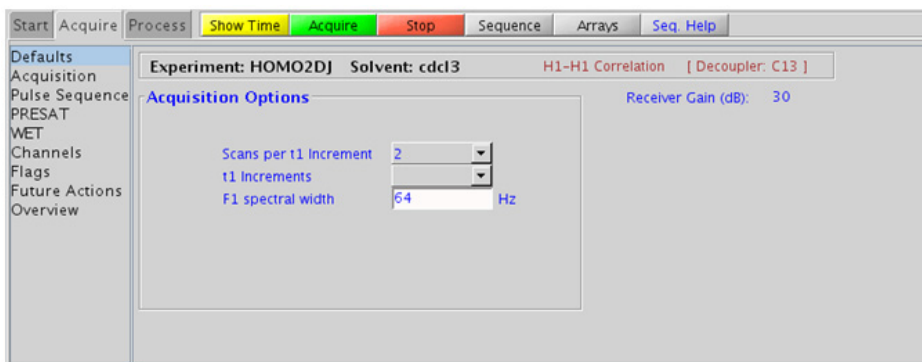

Processing

Automated processing is turned on by default, and the parameters are set to reasonable values, such that the resulting data after the acquisition usually require no further adjustment. The “Process” tab/“Basic” panel contains many of the commonly modified processing parameters, such as a pull-down menu to change the FT data size (8k x 128 is the default), as well as a check box to turn on/off linear prediction and a pull-down to control the extent of linear prediction (default is off). Menus to quickly change the weighting functions in F2/F1 are also present; the parameters for the weighting functions (defaults are squared sinebells) are calculated automatically from the acquisition time and number of increments. It is important to note that this experiment employs mix-mode processing, with the F2 dimension absolute value and F1 phase-sensitive. More processing details are found under some of the other “Process” panels, such as the “Default”, “Weighting”, and “More 2D” panels.

Tips, tricks, and next steps

- Spectral width (sw) and receiver gain (gain) settings transfer from a PROTON if the HOMO2DJ is set up from this experiment.
- It is highly recommended to adjust sw1 and ni such that ni/sw1 is equal to acquisition time (at) to accommodate the “45° rotate” that is typically applied during processing. Such equal resolution in both F1 and F2 dimension results in much better F2 projection (which mimics a proton decoupled proton spectrum).
- The default number of steady state scans (ss) that are acquired before data acquisition to establish sample equilibrium is 32, which works for most samples. This value is changed on the “Acquisition” panel of the “Acquire” tab if necessary.
- The default parameters use a Grad-90-Grad steady state between scans, which helps cleanup un-relaxed magnetization. This can result in much cleaner spectra, especially when using shorter acquisition times (at) and relaxation delays (d1) (defaults are 0.625s and 1s respectively).

References:

W. P. Aue, J. Karhan, R. R. Ernst, *J. Chem. Phys.* 64 (1976) 4226-4227.
(COSY)

L. Muller, A. Kumar, R. R. Ernst, *J. Magn. Reson.* 25 (1977) 383-390. (2DJ)

G. Bodenhausen, G. A. Morris, R. Freeman, D. L. Turner, *J. Magn. Reson.*
28 (1977) 17-28. (2DJ)

12 JSpectra

Tips, tricks, and next steps



13 Hadamard Encoded - Hadamard

Hadamard Tab	418
dqcosyHT	420
gcosyHT	424
hetcorHT	428
hmbcHT	432
hsqcHT	436
hsqctocsyHT	440
noesyHT	444
roesyHT	450
tocsyHT	454



Hadamard Tab

This tab of the Experiment Selector contains a suite of 2D experiments that employ Hadamard encoding. The concept behind Hadamard encoding is to excite the interesting chemical shifts

with an array of frequencies. The Hadamard method of acquiring 2D spectra does offer a 2D spectrum recorded at a fraction of the time of the similar traditional 2D experiment. The sensitivity of a Hadamard experiment is comparable to that of a traditional experiment per unit of time. Consequently the advantage of the Hadamard experiment is realized only when there is enough sensitivity (i.e., sample concentration) to record a fast 2D spectrum.

The specific frequencies for the Hadamard matrix are obtained by selection from a PROTON or a CARBON spectrum as appropriate. The experiments include a full set of standard two-dimensional pulse sequences including homonuclear experiments (dqcosyHT, gcosyHT, tocsyHT, noesyHT, and roesyHT), heteronuclear experiments (hsqcHT, hmbcHT, and hetcorHT), as well as an hsqctocsyHT experiment. All the experiments are processed using the Hadamard transformation, which is set by default in the processing parameters.

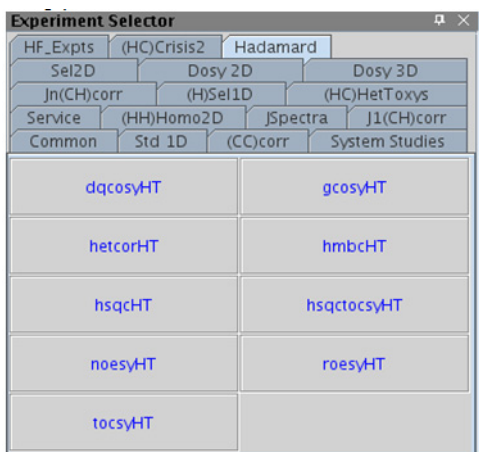

dqcosyHT

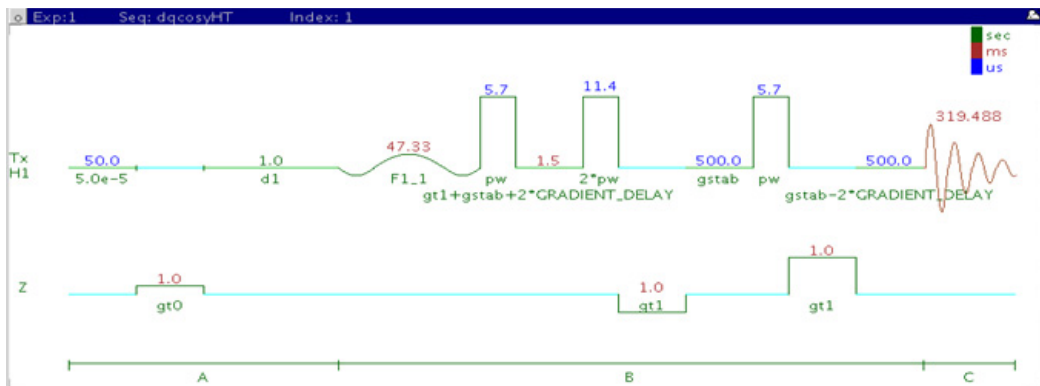

General description and usage

Description:

Two Dimensional double-quantum filtered J-correlation spectroscopy with Hadamard encoding.

Usage:

The dqcosyHT produces a 2-dimensional spectrum with peaks along the diagonal corresponding to the peaks in a 1D PROTON spectrum and crosspeaks between j-coupled protons. The Hadamard matrix is created from a previously acquired PROTON data set. The advantage of the dqcosyHT over the gcosyHT is that peaks with no double-quantum transitions (for example, singlets) are suppressed, producing cleaner spectra. The experiment is also phase sensitive, resulting in narrower peak shapes. The 90° pulse width is typically calibrated accurately for this experiment. All parameters are set from the “Acquire” tab/”Defaults” panel unless otherwise specified.

Key parameters

Parameter	Description
Hadamard Frequency List	Set from previously acquired PROTON- see Tips, tricks, and next steps for setup description
H1 pulse width (pw)	Type in calibrated 90° pulse value
Relaxation delay (d1)	Type in value- controls the delay between scans
Scans per increment (nt)	Select typical choices from pull down menu*
Steady state scans (ss)	Select typical choices from pull down menu*
Number of increments (ni)	Unlike ordinary 2D experiments the parameter ni defines the Hadamard matrix size (dictated by the number of regions that are excited)
Number of points in F2 (np)	Select typical choices from pull down menu- controls the resolution in F2
Fourier Number in F2	Select typical choices from pull down menu- usually 2*np

NOTE

Specific values for these parameters may be typed manually in the appropriate boxes on the "Acquisition" panel.

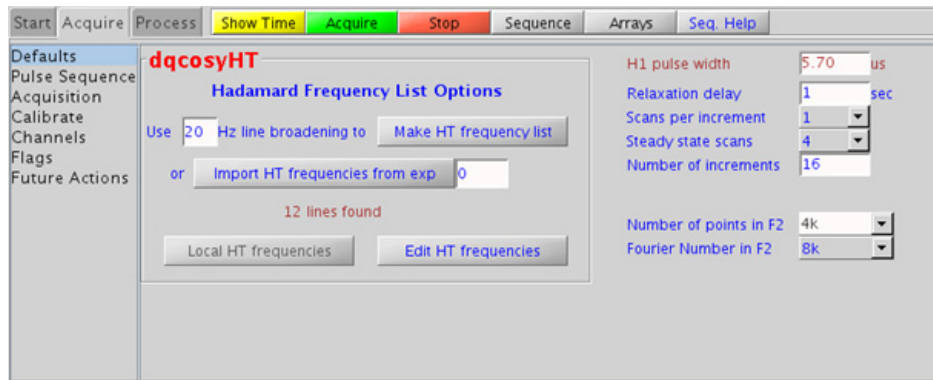

Processing

Automated processing is turned on by default, and the parameters are set to reasonable values, such that the resulting data after the acquisition usually require no further adjustment. Note that a Hadamard- transform is used, such that the parameter “proc1” is set to “ht”, which is the default. The “Process” tab/“Default” panel contains many of the commonly modified processing parameters, such as a pull-down menu to change the FT data size (4k x 256 is the default). Avoid arbitrarily setting the fn1 parameter, because its value is based upon the actual separation and bandwidths of frequencies in the Hadamard dimension, and is set automatically. More processing details are found under some of the other “Process” panels, such as the “Weighting” and “More 2D” panels.

Tips, tricks, and next steps

- To setup the Hadamard encoding frequencies, record, process, and autosave a PROTON spectrum. With the PROTON spectrum in current workspace select **Hadamard Experiments > Set Hadamard Encoding** from the Experiments menu to bring up the dialog box below. Click  to automatically create the frequency list:

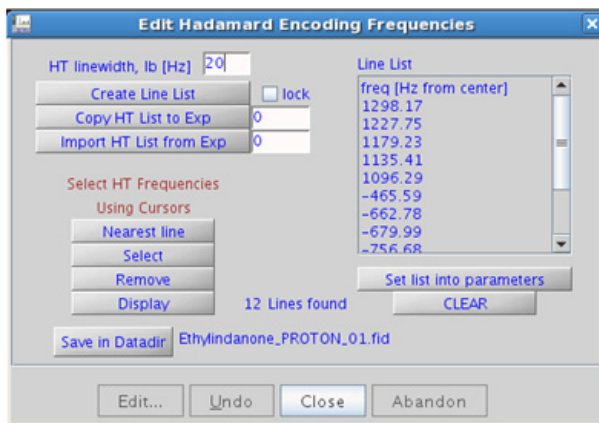

- Clear lock to edit the line list. Place the cursor on the peak to be added or removed and click or as appropriate. Click , save the Hadamard frequency list in the Data directory using , and close the dialog box. This frequency list is used for all subsequent Hadamard experiments with PROTON indirect dimension.
- The main advantage of the dqcosyHT versus the gcosyHT is better resolution (phase sensitive versus absolute value experiment) and the absence of singlets that display no couplings. For instance, t-butyl signals, which can be a large source of t1 noise because of their intensity, are suppressed in a dqcosyHT.
- The 90° pulse width needs to be calibrated accurately for best results from the dqcosyHT experiment. See the PROTON experiment in Chapter 2 to calibrate the pulse.

References:

W. P. Aue, J. Karhan, R. R. Ernst, J. Chem. Phys. 64 (1976) 4226-4227. (COSY)

U. Piantini, O. W. Sorensen, R. R. Ernst, J. Am. Chem. Soc. 104 (1982) 6800-6801. (Double Quantum Filter)

E. Kupce, R. Freeman, J. Magn. Reson. A105 (1993) 310-315. (Hadamard)

E. Kupce, T. Nishida, R. Freeman, Prog. NMR. Spectrosc. 42 (2003) 95-122. (Hadamard – Review)

gcosyHT

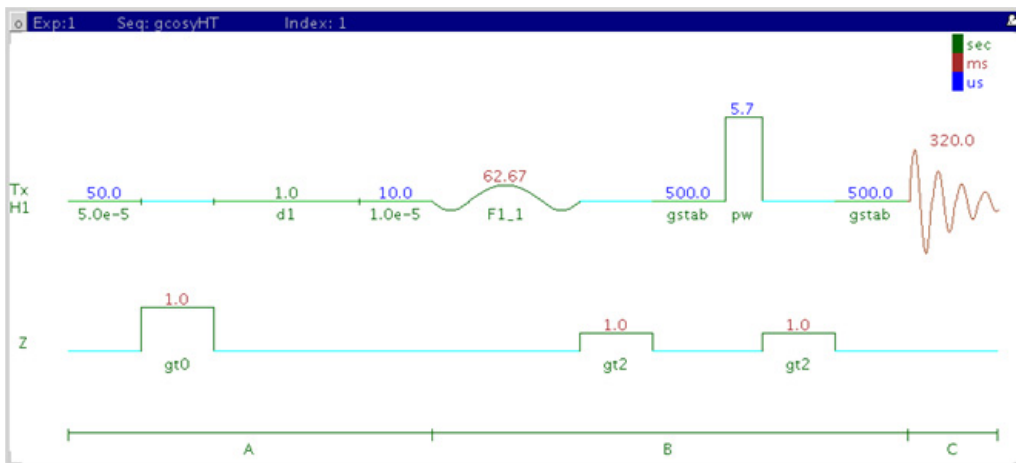

General description and usage

Description:

Two Dimensional J-correlation spectroscopy with Hadamard encoding and gradient coherence selection.

Usage:

The gcosyHT experiment produces a 2-dimensional spectrum with peaks along the diagonal corresponding to the peaks in a 1D PROTON spectrum and crosspeaks between j-coupled protons. The Hadamard matrix is created from a previously acquired PROTON data set. All parameters are set from the "Acquire" tab/"Defaults" panel unless otherwise specified.

Key parameters

Parameter	Description
Hadamard Frequency List	Set from previously acquired PROTON- see Tips, tricks, and next steps for setup description
H1 pulse width (pw)	Type in calibrated 90° pulse value
Relaxation delay (d1)	Type in value- controls the delay between scans
Scans per increment (nt)	Select typical choices from pull down menu*
Steady state scans (ss)	Select typical choices from pull down menu*
Number of increments (ni)	Unlike ordinary 2D experiments the parameter ni defines the Hadamard matrix size (dictated by the number of regions that are excited)
Number of points in F2 (np)	Select typical choices from pull down menu- controls the resolution in F2
Fourier Number in F2	Select typical choices from pull down menu- usually 2*np

NOTE

Specific values for these parameters may be typed manually in the appropriate boxes on the "Acquisition" panel.

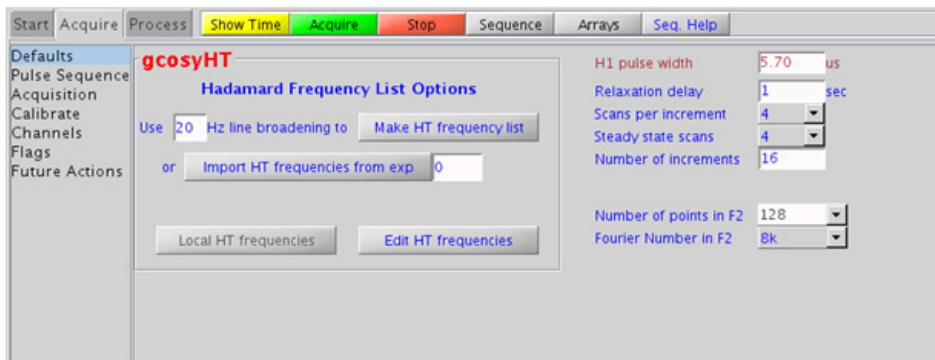

Processing

Automated processing is turned on by default, and the parameters are set to reasonable values, such that the resulting data after the acquisition usually require no further adjustment. Note that a Hadamard transform is used, such that the parameter “proc1” is set to “ht”, which is the default. The “Process” tab/“Default” panel contains many of the commonly modified processing parameters, such as a pull-down menu to change the FT data size (4k x 256 is the default). Avoid arbitrarily setting the fn1 parameter, because its value is based upon the actual separation and bandwidths of frequencies in the Hadamard dimension, and is set automatically. More processing details are found under some of the other “Process” panels, such as the “Weighting” and “More 2D” panels.

Tips, tricks, and next steps

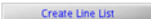
- To setup the Hadamard encoding frequencies, record, process, and autosave a PROTON spectrum. With the PROTON spectrum in current workspace select **Hadamard Experiments > Set Hadamard Encoding** from the Experiments menu to bring up the dialog box below. Click  to automatically create the frequency list:

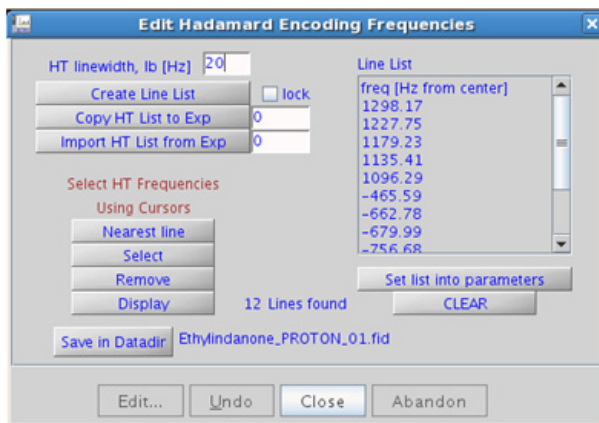

- Clear lock to edit the line list. Place the cursor on the peak to be added or removed and click or as appropriate. Click , save the Hadamard frequency list in the Data directory using , and close the dialog box. This frequency list is used for all subsequent Hadamard experiments with PROTON indirect dimension.

References:

W. P. Aue, J. Karhan, R. R. Ernst, J. Chem. Phys. 64 (1976) 4226-4227. (COSY)

R. E. Hurd, J. Magn. Reson. 87 (1990) 422-428. (Gradient based Coherence Selection)

E. Kupce, R. Freeman, J. Magn. Reson. A105 (1993) 310-315. (Hadamard)

E. Kupce, T. Nishida, R. Freeman, Prog. NMR. Spectrosc. 42 (2003) 95-122. (Hadamard – Review)

hetcorHT

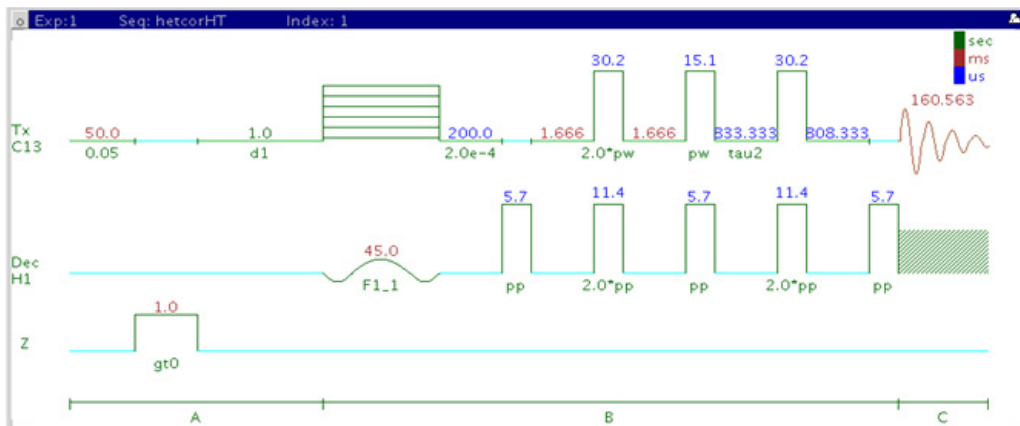

General description and usage

Description:

Two Dimensional heteronuclear 1-bond correlation with Hadamard encoding (carbon observe).

Usage:

The hetcorHT experiment is used to acquire a 2-dimensional spectrum to correlate protons to directly attached carbons, however unlike the HSQC/HMQC experiments it is carbon-detected, meaning the F1 dimension is ^1H and the F2 dimension is ^{13}C . The Hadamard matrix is created from a previously acquired PROTON data set. The experiment is much less sensitive than the proton-detected hsqcHT, and should only be used under special circumstances where higher resolution is desired in the carbon dimension. All parameters are set from the “Acquire” tab/”Defaults” panel unless otherwise specified.

Key parameters

Parameter	Description
Hadamard Frequency List	Set from previously acquired PROTON- see Tips, tricks, and next steps for setup description
H1/C13 pulse widths (pp/pw)	Type in calibrated 90° pulse values
Relaxation delay (d1)	Type in value- controls the delay between scans
Scans per increment (nt)	Select typical choices from pull down menu*
Steady state scans (ss)	Select typical choices from pull down menu*
Number of increments (ni)	Unlike ordinary 2D experiments the parameter ni defines the Hadamard matrix size (dictated by the number of regions that are excited)
Number of points in F2 (np)	Select typical choices from pull down menu- controls the resolution in F2
Fourier Number in F2	Select typical choices from pull down menu- usually 2*np

NOTE

Specific values for these parameters may be typed manually in the appropriate boxes on the "Acquisition" panel.

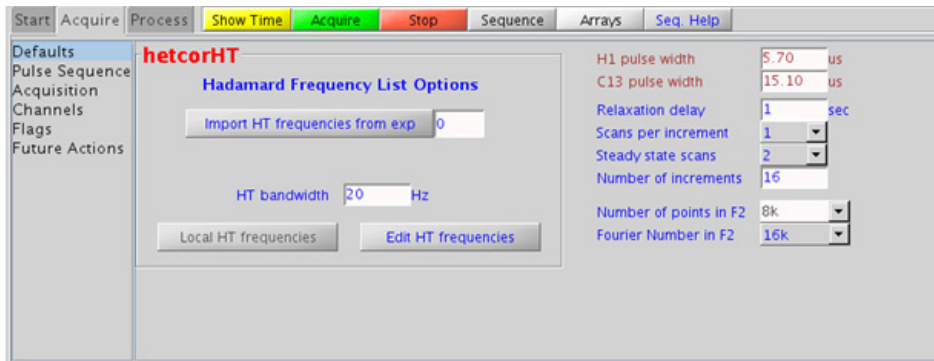

Processing

Automated processing is turned on by default, and the parameters are set to reasonable values, such that the resulting data after the acquisition usually require no further adjustment. Note that a Hadamard transform is used, such that the parameter “proc1” is set to “ht”, which is the default. The “Process” tab/“Default” panel contains many of the commonly modified processing parameters, such as a pull-down menu to change the FT data size (4k x 256 is the default). Avoid arbitrarily setting the fn1 parameter, because its value is based upon the actual separation and bandwidths of frequencies in the Hadamard dimension, and is set automatically. More processing details are found under some of the other “Process” panels, such as the “Weighting” and “More 2D” panels.

Tips, tricks, and next steps

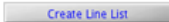
- To setup the Hadamard encoding frequencies, record, process, and autosave a PROTON spectrum. With the PROTON spectrum in current workspace select **Hadamard Experiments > Set Hadamard Encoding** from the Experiments menu to bring up the dialog box below. Click  to automatically create the frequency list:

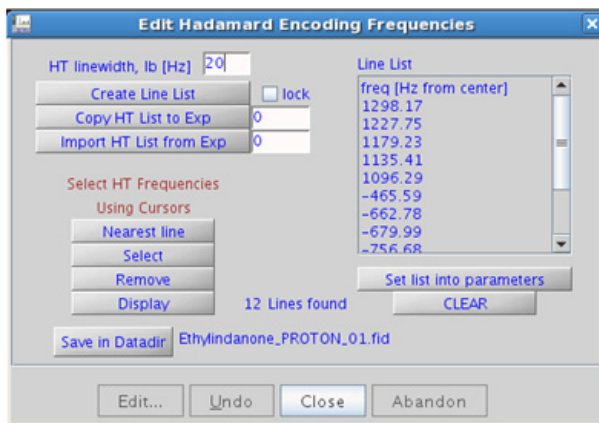

- Clear lock to edit the line list. Place the cursor on the peak to be added or removed and click or as appropriate. Click , save the Hadamard frequency list in the Data directory using , and close the dialog box. This frequency list is used for all subsequent Hadamard experiments with PROTON indirect dimension.
- The 90° pulse widths for ^1H and ^{13}C need to be calibrated accurately for best results from the hetcorHT experiment.
- In general, the hsqcHT experiment is more sensitive than the hetcorHT. The advantage of the hetcorHT, though, is that a much higher resolution is achieved for the carbon, the F2, dimension. The resulting proton spectrum along the F1 dimensions is effectively a ^1H decoupled proton spectrum.
- Parameters to adjust the type and power for ^{13}C and/or ^1H decoupling are found on the “Pulse Sequence” tab.

References:

- A. Bax, G. A. Morris, J. Magn. Reson. 42 (1981) 501-505. (HETCOR)
- E. Kupce, R. Freeman, J. Magn. Reson. A105 (1993) 310-315. (Hadamard)
- E. Kupce, T. Nishida, R. Freeman, Prog. NMR. Spectrosc. 42 (2003) 95-122. (Hadamard – Review)

hmbcHT

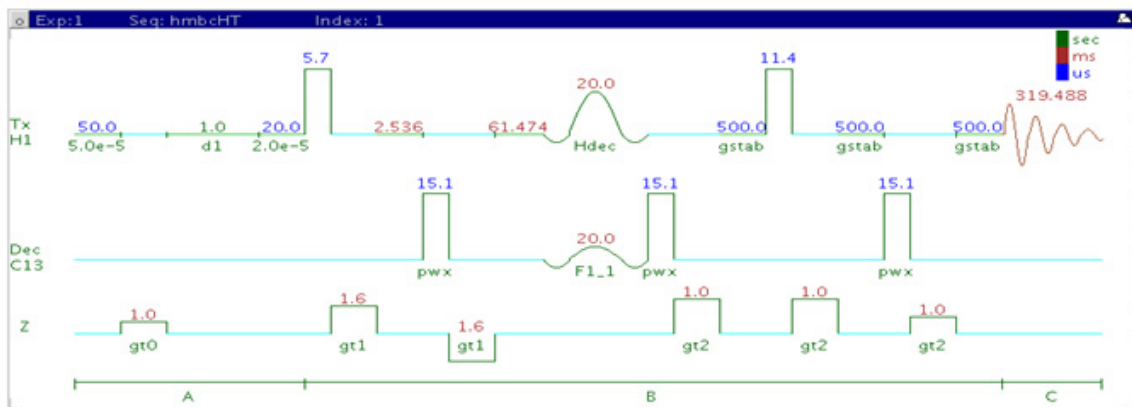

General description and usage

Description:

Two Dimensional heteronuclear multiple-bond J-correlation spectroscopy with Hadamard encoding.

Usage:

The hmbcHT experiment is used to acquire a two-dimensional spectrum to correlate protons to carbons over long range couplings, usually over 2-3 bonds. The Hadamard matrix is created from a previously acquired CARBON data set before acquisition. All parameters are set from the "Acquire" tab/"Defaults" panel unless otherwise specified.

Key parameters

Parameter	Description
Hadamard Frequency List	Set from previously acquired CARBON- see Tips, tricks, and next steps for setup description
H1/C13 pulse widths (pw/pwx)	Type in calibrated 90° pulse values
Relaxation delay (d1)	Type in value- controls the delay between scans
Scans per increment (nt)	Select typical choices from pull down menu*
Steady state scans (ss)	Select typical choices from pull down menu*
Number of increments (ni)	Unlike ordinary 2D experiments the parameter ni defines the Hadamard matrix size (dictated by the number of regions that are excited)
Number of points in F2 (np)	Select typical choices from pull down menu- controls the resolution in F2
Fourier Number in F2	Select typical choices from pull down menu- usually 2*np

NOTE

Specific values for these parameters may be typed manually in the appropriate boxes on the "Acquisition" panel.

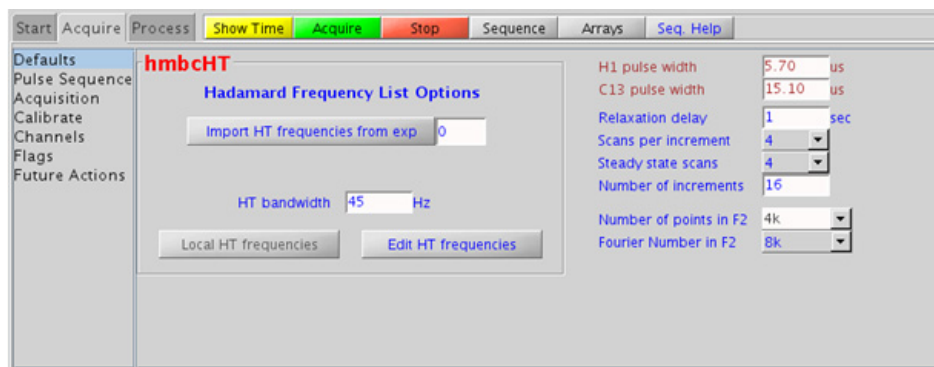

Processing

Automated processing is turned on by default, and the parameters are set to reasonable values, such that the resulting data after the acquisition usually require no further adjustment. Note that a Hadamard transform is used, such that the parameter “proc1” is set to “ht”, which is the default. The “Process” tab/“Default” panel contains many of the commonly modified processing parameters, such as a pull-down menu to change the FT data size (4k x 256 is the default). Avoid arbitrarily setting the fn1 parameter, because its value is based upon the actual separation and bandwidths of frequencies in the Hadamard dimension, and is set automatically. More processing details are found under some of the other “Process” panels, such as the “Weighting” and “More 2D” panels.

Tips, tricks, and next steps

- To setup the Hadamard encoding frequencies, record, process, and autosave a CARBON spectrum. With the PROTON spectrum in current workspace select Hadamard Experiments > Set Hadamard Encoding from the Experiments menu to bring up the dialog box below. Click  to automatically create the frequency list:

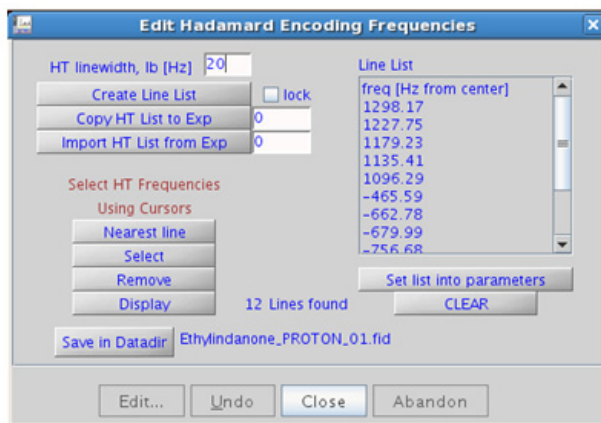

- Clear lock to edit the line list. Place the cursor on the peak to be added or removed and click or as appropriate. Click , save the Hadamard frequency list in the Data directory using , and close the dialog box. This frequency list is used for all subsequent Hadamard experiments with CARBON indirect dimension.
- While editing the CARBON frequency list, it is important to remove solvent resonances from the list.
- Parameters to adjust the J-couplings $^1J_{C,H}$ and $^nJ_{C,H}$ (defaults are 140 Hz and 8 Hz) are found on the “Pulse Sequence” tab. The jnxh sets the optimal value of the proton-carbon coupling constant for detection. Using smaller values may increase the chances of seeing longer-range correlations, but at the expense of correlations with larger coupling constants, and, more importantly, at the expense of sensitivity.

References:

- A. Bax, M. F. Summers, J. Am. Chem. Soc. 108 (1986) 2093-2094. (HMBC)
- E. Kupce, R. Freeman, J. Magn. Reson. A105 (1993) 310-315. (Hadamard)
- E. Kupce, T. Nishida, R. Freeman, Prog. NMR. Spectrosc. 42 (2003) 95-122. (Hadamard – Review)

hsqcHT

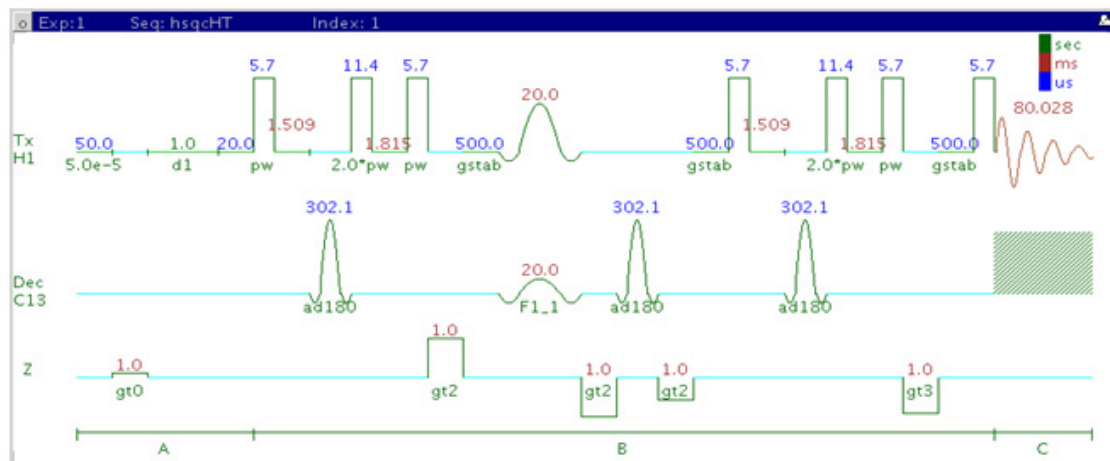

General description and usage

Description:

Two Dimensional heteronuclear single-quantum 1-bond J-correlation spectroscopy with Hadamard encoding.

Usage:

The hsqcHT experiment is used to acquire a 2-dimensional spectrum to correlate protons to directly attached carbons. The Hadamard matrix is created from a previously acquired CARBON data set before acquisition. All parameters are set from the “Acquire” tab/”Defaults” panel unless otherwise specified.

Key parameters

Parameters	Description
Hadamard Frequency List	Set from previously acquired PROTON- see Tips, tricks, and next steps for setup description
H1/C13 pulse widths (pw/pwx)	Type in calibrated 90° pulse values
Relaxation delay (d1)	Type in value- controls the delay between scans
Scans per increment (nt)	Select typical choices from pull down menu*
Steady state scans (ss)	Select typical choices from pull down menu*
Number of increments (ni)	Unlike ordinary 2D experiments the parameter ni defines the Hadamard matrix size (dictated by the number of regions that are excited)
Number of points in F2 (np)	Select typical choices from pull down menu- controls the resolution in F2
Fourier Number in F2	Select typical choices from pull down menu- usually 2*np

NOTE

Specific values for these parameters may be typed manually in the appropriate boxes on the "Acquisition" panel.

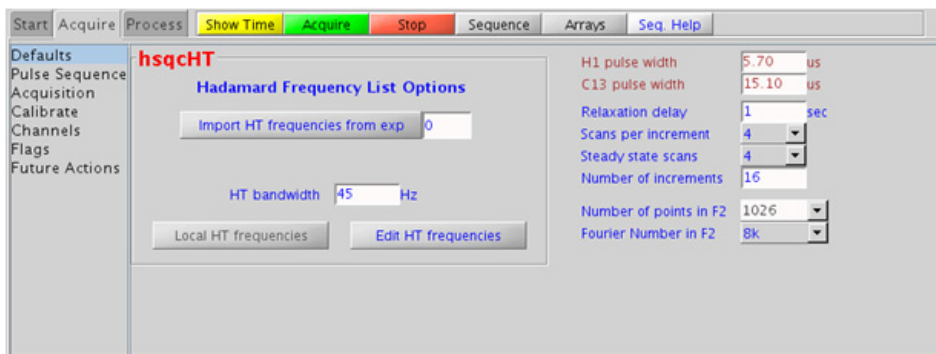

Processing

Automated processing is turned on by default, and the parameters are set to reasonable values, such that the resulting data after the acquisition usually require no further adjustment. Note that a Hadamard transform is used, such that the parameter “proc1” is set to “ht”, which is the default. The “Process” tab/“Default” panel contains many of the commonly modified processing parameters, such as a pull-down menu to change the FT data size (4k x 256 is the default). Avoid arbitrarily setting the fn1 parameter, because its value is based upon the actual separation and bandwidths of frequencies in the Hadamard dimension, and is set automatically. More processing details are found under some of the other “Process” panels, such as the “Weighting” and “More 2D” panels.

Tips, tricks, and next steps

- To setup the Hadamard encoding frequencies, record, process, and autosave a CARBON spectrum. With the PROTON spectrum in current workspace select Experiments menu ® Hadamard Experiments ® Set Hadamard Encoding from the menu to bring up the dialog box below. Click  to automatically create the frequency list:

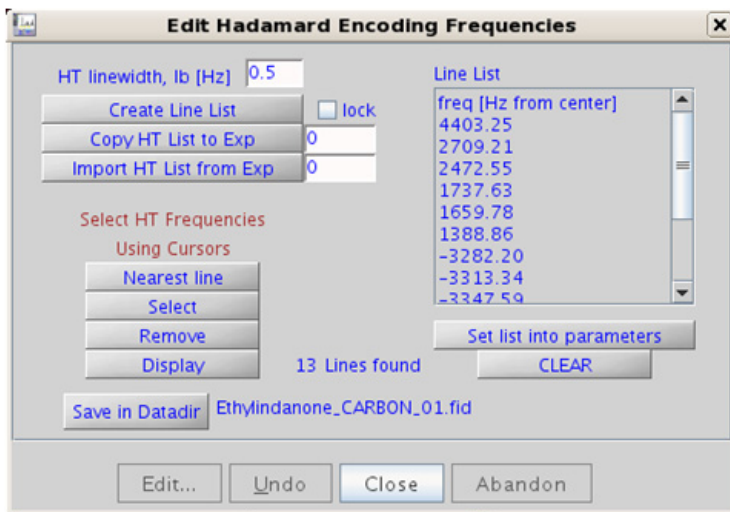

- Clear lock to edit the line list. Place the cursor on the peak to be added or removed and click **Select** or **Remove** as appropriate. Click **Set list into parameters**, save the Hadamard frequency list in the Data directory using **Save in Datadir**, and close the dialog box. This frequency list is used for all subsequent Hadamard experiments with CARBON indirect dimension.
- While editing the CARBON frequency list, it is important to remove solvent resonances from the list.
- Parameters to adjust the type and power for ^{13}C decoupling are found on the “Pulse Sequence” tab. To measure ^1H - ^{13}C (or ^1H -X) coupling constants, the carbon decoupling is turned off by entering “nnn” in the Channel 2 “Dec On/Off” entry on the “Channels” panel or alternatively by typing `dm='nnn'` on the command line.

References:

G. Bodenhausen, D. J. Ruben, Chem. Phys. Lett. 69 (1980) 185-189.
(HSQC)

E. Kupce, R. Freeman, J. Magn. Reson. A105 (1993) 310-315. (Hadamard)

E. Kupce, T. Nishida, R. Freeman, Prog. NMR. Spectrosc. 42 (2003) 95-122.
(Hadamard – Review)

hsqctocsyHT

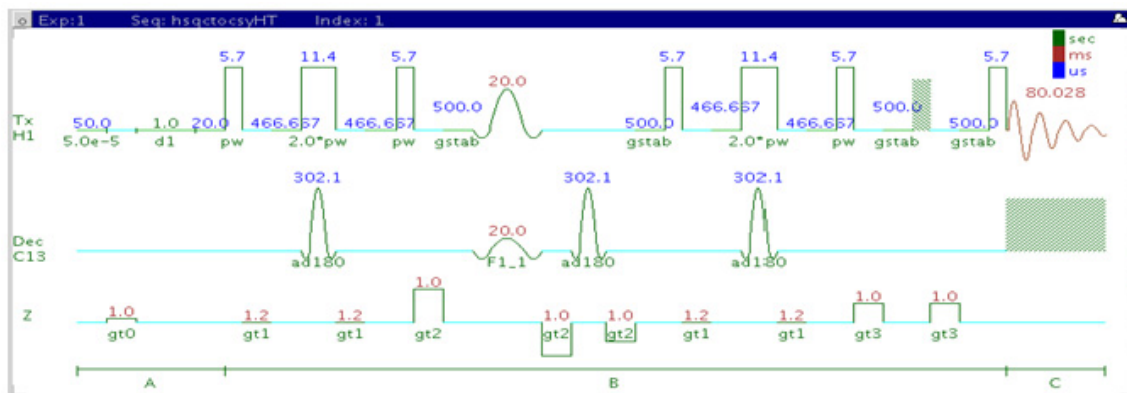

General description and usage

Description:

Two Dimensional heteronuclear single-quantum 1-bond J-correlation spectroscopy with a TOCSY spinlock and Hadamard encoding.

Usage:

The hsqctocsyHT experiment is used to acquire a 2-dimensional spectrum to connect ^1H TOCSY correlations with ^{13}C nuclei chemical shift information. For example, Proton A is in the same spin system as proton B at carbon chemical shift X. The experiment is useful to resolve overlapping spin systems in the ^1H TOCSY by spreading them out over the carbon (or other X-nuclei) chemical shift range. The Hadamard matrix is created from a previously acquired CARBON data set. All parameters are set from the "Acquire" tab/"Defaults" panel unless otherwise specified.

Key parameters

Parameter	Description
Hadamard Frequency List	Set from previously acquired CARBON- see Tips, tricks, and next steps for setup description
H1/C13 pulse widths (pw/pwx)	Type in calibrated 90° pulse values
Relaxation delay (d1)	Type in value- controls the delay between scans
Scans per increment (nt)	Select typical choices from pull down menu*
Steady state scans (ss)	Select typical choices from pull down menu*
Number of increments (ni)	Unlike ordinary 2D experiments the parameter ni defines the Hadamard matrix size (dictated by the number of regions that are excited)
Mixing time (mix)	Select from pull down menu- 80ms works best for large spin systems*
Number of points in F2 (np)	Select typical choices from pull down menu- controls the resolution in F2
Fourier Number in F2	Select typical choices from pull down menu- usually 2*np
Hadamard Frequency List	Set from previously acquired CARBON- see Tips, tricks, and next steps for setup description
H1/C13 pulse widths (pw/pwx)	Type in calibrated 90° pulse values

NOTE

Specific values for these parameters may be typed manually in the appropriate boxes on the "Acquisition" panel.

13 Hadamard Encoded - Hadamard Processing

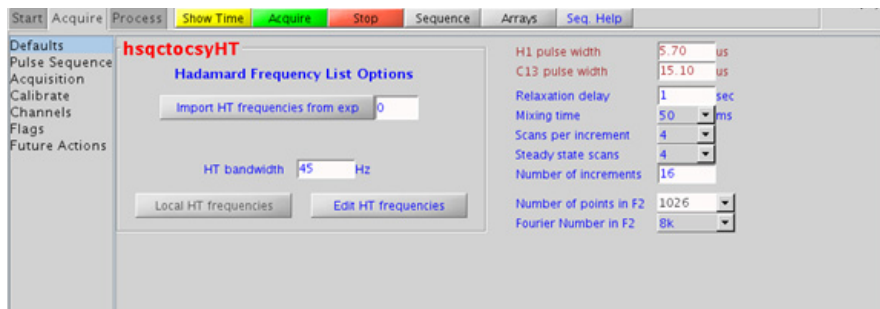

Processing

Automated processing is turned on by default, and the parameters are set to reasonable values, such that the resulting data after the acquisition usually require no further adjustment. Note that a Hadamard transform is used, such that the parameter “proc1” is set to “ht”, which is the default. The “Process” tab/“Default” panel contains many of the commonly modified processing parameters, such as a pull-down menu to change the FT data size (4k x 256 is the default). Avoid arbitrarily setting the fn1 parameter, because its value is based upon the actual separation and bandwidths of frequencies in the Hadamard dimension, and is set automatically. More processing details are found under some of the other “Process” panels, such as the “Weighting” and “More 2D” panels.

Tips, tricks, and next steps

- To setup the Hadamard encoding frequencies, record, process, and autosave a CARBON spectrum. With the PROTON spectrum in current workspace select **Hadamard Experiments > Set Hadamard Encoding** from the Experiments menu to bring up the dialog box below. Click  to automatically create the frequency list:

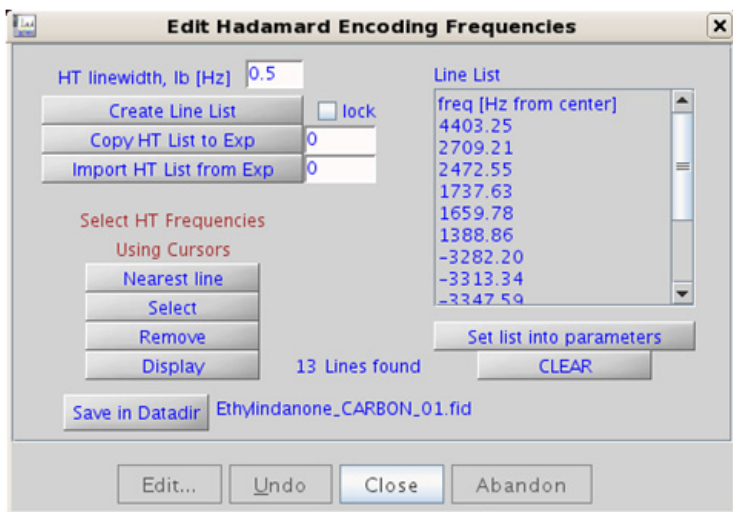

- Clear lock to edit the line list. Place the cursor on the peak to be added or removed and click **Select** or **Remove** as appropriate. Click **Set list into parameters**, save the Hadamard frequency list in the Data directory using **Save in Datadir**, and close the dialog box. This frequency list is used for all subsequent Hadamard experiments with CARBON indirect dimension.
- While editing the CARBON frequency list, it is important to remove solvent resonances from the list.

References:

- K. E. Kover, O. Prakash, V, J. Hruby, J. Magn. Reson. A103 (1993) 92-96. (z-filtered HSQC-TOCSY)
- E. Kupce, R. Freeman, J. Magn. Reson. A105 (1993) 310-315. (Hadamard)
- E. Kupce, T. Nishida, R. Freeman, Prog. NMR. Spectrosc. 42 (2003) 95-122. (Hadamard – Review)

13 Hadamard Encoded - Hadamard

noesyHT

noesyHT

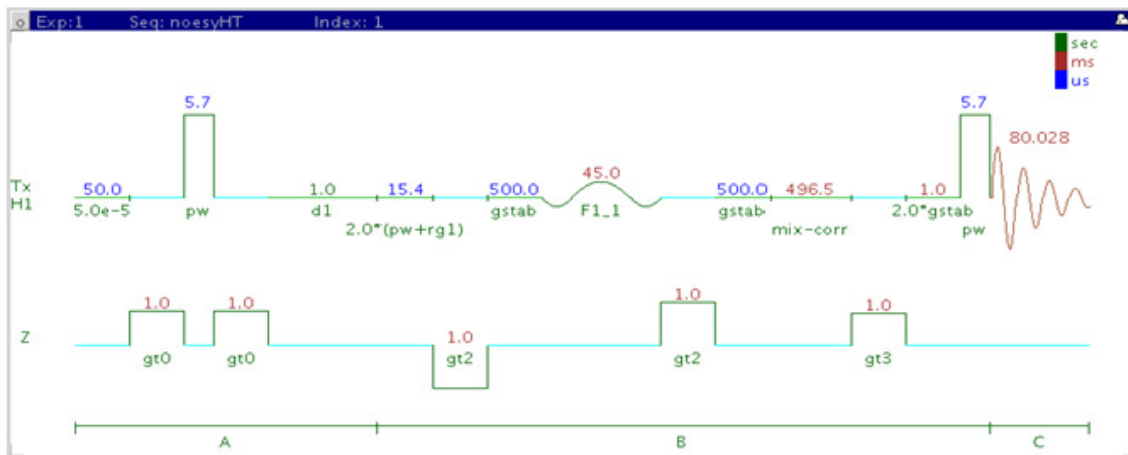

General description and usage

Description:

Two Dimensional through-space correlation spectroscopy with Hadamard encoding.

Usage:

The noesyHT experiment produces a 2-dimensional spectrum with peaks along the diagonal corresponding to the peaks in a 1D PROTON and crosspeaks between protons that are close in space (typically $<5 \text{ \AA}$). The Hadamard matrix is created from a previously acquired PROTON data set. All parameters are set from the "Acquire" tab/"Defaults" panel unless otherwise specified.

Key parameters

Parameter	Description
Hadamard Frequency List	Set from previously acquired PROTON- see Tips, tricks, and next steps for setup description
H1 pulse width (pw)	Type in calibrated 90° pulse value
Relaxation delay (d1)	Type in value- controls the delay between scans
Mixing time (mix)	Select from pull down menu- 500ms works well as a starting point*
Scans per increment (nt)	Select typical choices from pull down menu*
Steady state scans (ss)	Select typical choices from pull down menu*
Number of increments (ni)	Unlike ordinary 2D experiments the parameter ni defines the Hadamard matrix size (dictated by the number of regions that are excited)
Number of points in F2 (np)	Select typical choices from pull down menu- controls the resolution in F2
Fourier Number in F2	Select typical choices from pull down menu- usually 2*np

NOTE

Specific values for these parameters may be typed manually in the appropriate boxes on the "Acquisition" panel.

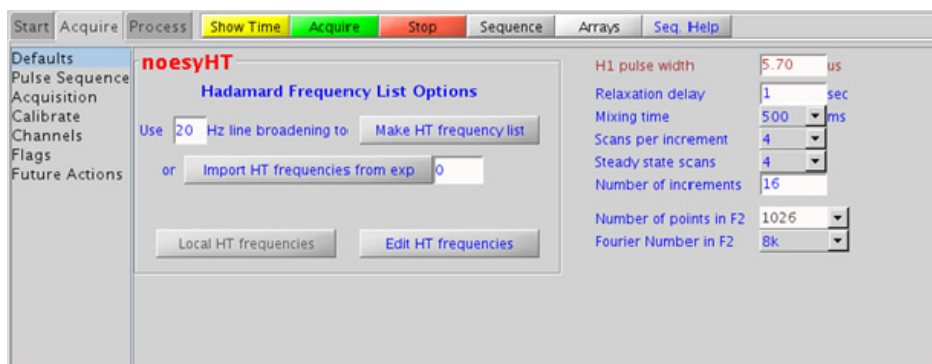

Processing

Automated processing is turned on by default, and the parameters are set to reasonable values, such that the resulting data after the acquisition usually require no further adjustment. Note that a Hadamard transform is used, such that the parameter “proc1” is set to “ht”, which is the default. The “Process” tab/“Default” panel contains many of the commonly modified processing parameters, such as a pull-down menu to change the FT data size (4k x 256 is the default). Avoid arbitrarily setting the fn1 parameter, because its value is based upon the actual separation and bandwidths of frequencies in the Hadamard dimension, and is set automatically. More processing details are found under some of the other “Process” panels, such as the “Weighting” and “More 2D” panels.

Tips, tricks, and next steps

- To setup the Hadamard encoding frequencies, record, process, and autosave a PROTON spectrum. With the PROTON spectrum in current workspace select Hadamard Experiments > Set Hadamard Encoding from the Experiments menu to bring up the dialog box below. Click  to automatically create the frequency list:

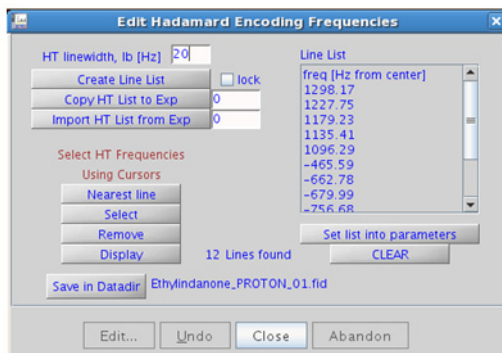

- Clear lock to edit the line list. Place the cursor on the peak to be added or removed and click **Select** or **Remove** as appropriate. Click **Set list into parameters**, save the Hadamard frequency list in the Data directory using **Save in DataDir**, and close the dialog box. This frequency list is used for all subsequent Hadamard experiments with PROTON indirect dimension.
- The default parameters use a Grad-90-Grad steady state between scans, which helps cleanup un-relaxed magnetization. This can result in much cleaner spectra, especially when using shorter acquisition times (at) and relaxation delays (d1) (defaults are 0.15s and 1s, respectively).
- A mixing time of 500ms is a good starting place for most small molecules. Very small molecules and/or weak NOE interactions may require longer mixing times (up to ~1s). Longer mixing times, however, increase the possibility of spin diffusion for larger molecules, a situation where the magnetization is transferred through space, and then through coupling, resulting in spurious correlations between protons. The NOE correlation is confirmed by acquiring a build-up curve, whereby the mixing time is slowly increased in 50-100ms increments until the NOE intensity ceases to increase and levels off. This is the optimal mixing time.
- Medium-sized molecules (MW ~500 depending on the molecule and spectrometer frequency) can exhibit zero or very small NOEs. Consider acquiring a roesyHT for these molecules. Alternatively one may consider, (i) choosing a more viscous solvent such as d₆-DMSO or d₆-DMSO with ~10-20% D₂O (which results in slower molecular tumbling and hence generates a positive NOE enhancement like larger molecules), (ii) selecting a lower temperature (if the solvent allows it), or (iii) running the experiment on a spectrometer with higher field strength (if available).
- Small molecules may have crosspeaks arising from chemical exchange during the NOE mixing time and have the same phase as the diagonal. The exchange crosspeaks provide information about inter-converting molecular conformations and can be used to recognize such molecular dynamic processes.

References:

S. Macura, Y. Huang, D. Suter, R. R. Ernst, J. Magn. Reson. 43 (1981) 259-281. (NOESY)

13 Hadamard Encoded - Hadamard

Tips, tricks, and next steps

E. Kupce, T. Nishida, R. Freeman, *Prog. NMR. Spectrosc.* 42 (2003) 95-122.
(Hadamard – Review)

roesyHT

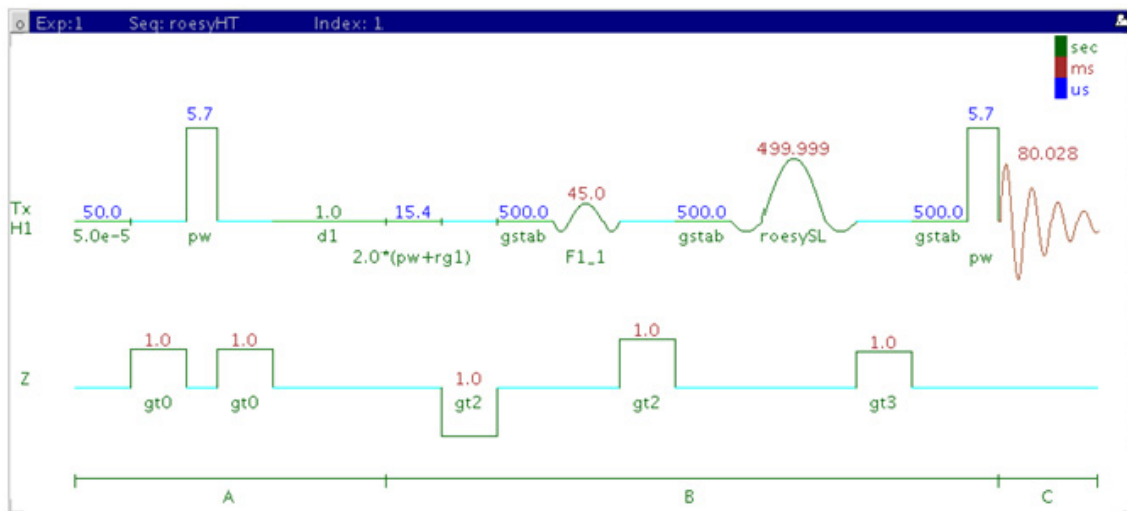

General description and usage

Description:

Two Dimensional through-space correlation spectroscopy in the rotating frame with Hadamard encoding.

Usage:

The roesyHT experiment produces a 2-dimensional spectrum with peaks along the diagonal corresponding to the peaks in a 1D PROTON and crosspeaks between protons that are close in space (typically $<4 \text{ \AA}$). The Hadamard matrix is created from a previously acquired PROTON data set. All parameters are set from the "Acquire" tab/"Defaults" panel unless otherwise specified.

Key parameters

Parameters	Description
Hadamard Frequency List	Set from previously acquired PROTON- see Tips, tricks, and next steps for setup description
H1 pulse width (pw)	Type in calibrated 90° pulse value
Relaxation delay (d1)	Type in value- controls the delay between scans
Mixing time (mix)	Select from pull down menu- 200ms works well for most small molecules* DO NOT EXCEED 500ms*
Scans per increment (nt)	Select typical choices from pull down menu*
Steady state scans (ss)	Select typical choices from pull down menu*
Number of increments (ni)	Unlike ordinary 2D experiments the parameter ni defines the Hadamard matrix size (dictated by the number of regions that are excited)
Number of points in F2 (np)	Select typical choices from pull down menu- controls the resolution in F2
Fourier Number in F2	Select typical choices from pull down menu- usually 2*np

NOTE

Specific values for these parameters may be typed manually in the appropriate boxes on the "Acquisition" panel.



Processing

Automated processing is turned on by default, and the parameters are set to reasonable values, such that the resulting data after the acquisition usually require no further adjustment. Note that a Hadamard transform is used, such that the parameter “proc1” is set to “ht”, which is the default. The “Process” tab/“Default” panel contains many of the commonly modified processing parameters, such as a pull-down menu to change the FT data size (4k x 256 is the default). Avoid arbitrarily setting the fn1 parameter, because its value is based upon the actual separation and bandwidths of frequencies in the Hadamard dimension, and is set automatically. More processing details are found under some of the other “Process” panels, such as the “Weighting” and “More 2D” panels.

Tips, tricks, and next steps

- To setup the Hadamard encoding frequencies, record, process, and autosave a PROTON spectrum. With the PROTON spectrum in current workspace select Hadamard Experiments > Set Hadamard Encoding from the Experiments menu to bring up the dialog box below. Click  to automatically create the frequency list:

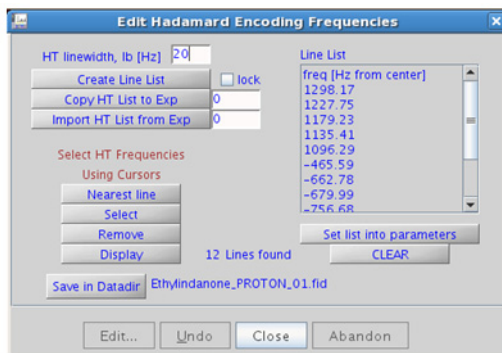

- Clear lock to edit the line list. Place the cursor on the peak to be added or removed and click or as appropriate. Click , save the Hadamard frequency list in the Data directory using , and close the dialog box. This frequency list is used for all subsequent Hadamard experiments with PROTON indirect dimension.
- A mixing time of 200ms is a good starting place for most small molecules. Very weak ROE interactions may require longer mixing times (up to ~500ms), but keep the mixing time shorter as longer spinlocks may result in sample heating. It is a good idea not to exceed a 500ms spinlock.
- Because the mixing time for the roesyHT is limited, weaker correlations may not be observable. roesyHT is the experiment of choice over noesyHT for medium-sized molecules (MW ~800-1000 depending on the molecule and spectrometer frequency), as they can exhibit zero or very small NOEs. One may consider running noesyHT experiments (which can be run with longer mixing times) by (i) choosing a more viscous solvent such as d₆-DMSO or d₆-DMSO with ~10-20% D₂O (which results in slower molecular tumbling and hence generates a positive NOE enhancement like larger molecules), (ii) selecting a lower temperature (if the solvent allows it), or (iii) running the experiment on a spectrometer with higher field strength (if available).
- Crosspeaks in the roesyHT spectrum that have the same phase as the diagonal may arise from chemical exchange during the ROE mixing time, or due to TOCSY-type correlations (couplings). The exchange crosspeaks provide information about inter-converting molecular conformations and can be used to recognize such molecular dynamic processes.

References:

- A. Bax, D. G. Davis, J. Magn. Reson. 63 (1985) 207-213. (ROESY)
- E. Kupce, R. Freeman, J. Magn. Reson. A105 (1993) 310-315. (Hadamard)
- E. Kupce, T. Nishida, R. Freeman, Prog. NMR. Spectrosc. 42 (2003) 95-122. (Hadamard – Review)

tocsyHT

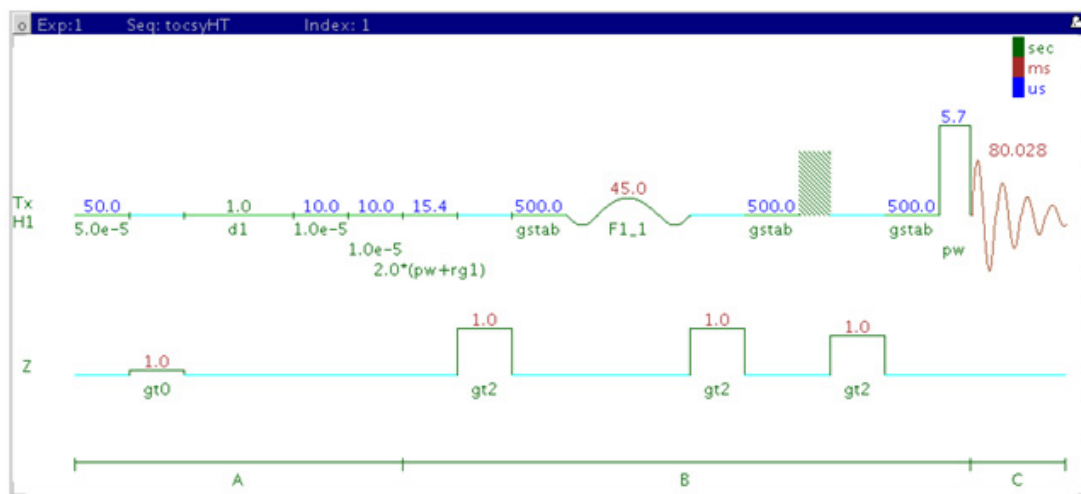

General description and usage

Description:

Two Dimensional total J-correlation spectroscopy for scalar coupled spin systems with Hadamard encoding.

Usage:

The tocsyHT experiment produces a 2-dimensional spectrum with peaks along the diagonal corresponding to the peaks in a 1D PROTON and crosspeaks between all protons in a scalar coupled spin system. The Hadamard matrix is created from a previously acquired PROTON data set. All parameters are set from the “Acquire” tab/”Defaults” panel unless otherwise specified.

Key parameters

Parameters	Description
Hadamard Frequency List	Set from previously acquired PROTON- see Tips, tricks, and next steps for setup description
H1 pulse width (pw)	Type in calibrated 90° pulse value
Relaxation delay (d1)	Type in value- controls the delay between scans
Mixing time (mix)	Select from pull down menu- 80ms works best for large spin systems*
Scans per increment (nt)	Select typical choices from pull down menu*
Steady state scans (ss)	Select typical choices from pull down menu*
Number of increments (ni)	Unlike ordinary 2D experiments the parameter ni defines the Hadamard matrix size (dictated by the number of regions that are excited)
Number of points in F2 (np)	Select typical choices from pull down menu- controls the resolution in F2
Fourier Number in F2	Select typical choices from pull down menu- usually 2*np

NOTE

Specific values for these parameters may be typed manually in the appropriate boxes on the "Acquisition" panel.

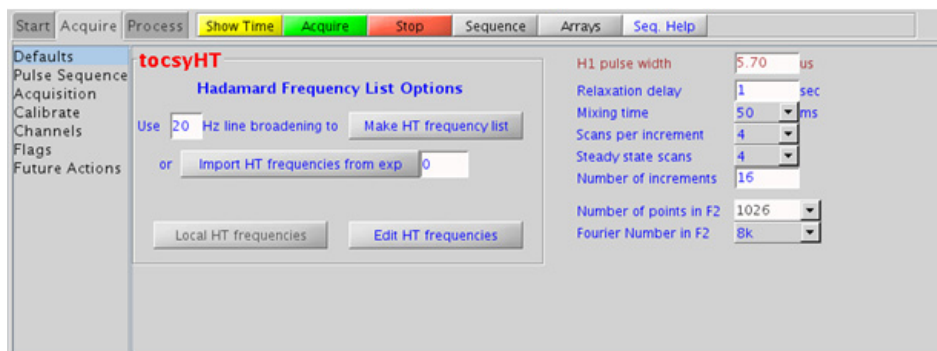

Processing

Automated processing is turned on by default, and the parameters are set to reasonable values, such that the resulting data after the acquisition usually require no further adjustment. Note that a Hadamard transform is used, such that the parameter “proc1” is set to “ht”, which is the default. The “Process” tab/“Default” panel contains many of the commonly modified processing parameters, such as a pull-down menu to change the FT data size (4k x 256 is the default). Avoid arbitrarily setting the fn1 parameter, because its value is based upon the actual separation and bandwidths of frequencies in the Hadamard dimension, and is set automatically. More processing details are found under some of the other “Process” panels, such as the “Weighting” and “More 2D” panels.

Tips, tricks, and next steps

- To setup the Hadamard encoding frequencies, record, process, and autosave a PROTON spectrum. With the PROTON spectrum in current workspace select Hadamard Experiments > Set Hadamard Encoding from the Experiments menu to bring up the dialog box below. Click  to automatically create the frequency list:

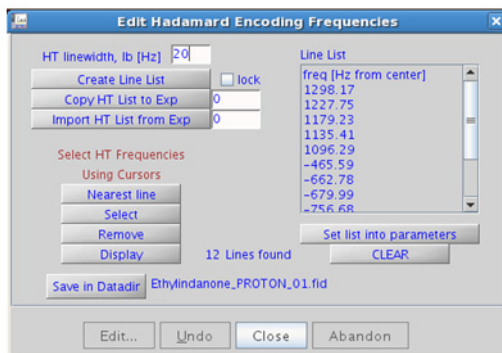

- Clear lock to edit the line list. Place the cursor on the peak to be added or removed and click **Select** or **Remove** as appropriate. Click **Set list into parameters**, save the Hadamard frequency list in the Data directory using **Save in DataDir**, and close the dialog box. This frequency list is used for all subsequent Hadamard experiments with PROTON indirect dimension.
- The spinlock time ultimately controls how far along the spin system the correlations extend. A value of 50 or 80ms is typically a good choice.
- A pull-down menu to change the waveform for the tocsyHT spinlock is found on the “Pulse Sequence”. The DIPSI2 spinlock pattern is a good choice for small molecules and FLOPSY8 is typically used for larger molecules.

References:

- A. Bax, D. G. Davis, J. Magn. Reson. 63 (1985) 355-360. (TOCSY with MLEV17)
- E. Kupce, R. Freeman, J. Magn. Reson. A105 (1993) 310-315. (Hadamard)
- E. Kupce, T. Nishida, R. Freeman, Prog. NMR. Spectrosc. 42 (2003) 95-122. (Hadamard – Review)

13 Hadamard Encoded - Hadamard

Tips, tricks, and next steps

Index

Symbols

(C)APT, 62
 (C)DEPT, 66
 (H)HomoDec, 74
 (H)PRESAT, 42
 (H)wet1D, 48
 (HC)bsgHMBC, 258
 (HC)bsgHSQCAD, 254
 (HC)bsHSQCAD, 250
 (HC)bsHSQCNOESY, 266
 (HC)bsHSQCROESY, 272
 (HC)EXSIDE, 262
 (HH)bsNOESY, 286
 (HH)bsROESY, 278
 (HH)bsTOCSY, 282

A

ADEQUATEAD, 378
 ASAPHMOC, 168

B

BilevelDec, 82

C

c2hsqc, 298
 c2hsqcse, 294
 CARBON, 30
 CARBONecho, 78
 CIGAR, 192
 CIGARAD, 196
 COSY, 94

D

DQCOSY, 102
 dqcosyHT, 418

F

FH_gHETCOR, 386
 FH_HOESY, 390
 FLUORINE, 34
 FObs_HDec, 394

G

gc2h2bc, 306
 gc2h2bcme, 302
 gc2hmbc, 316
 gc2hmbcme, 310
 gc2hsqc, 324
 gc2hsqcse, 320
 gCOSY, 90
 gcosyHT, 422
 gDQCOSY, 98
 gH2BC, 188
 gH2BCAD, 184
 gHETCOR, 164
 gHMBC, 180
 gHMBCAD, 176
 gHMBCmeAD, 204
 gHMBCRELAY, 210
 gHMQC, 156
 gHMQCTOXY, 362
 gHSQC, 148
 gHSQCAD, 138
 gHSQCADTOXY, 338
 gHSQCCTOXY, 350

H

HETCOR, 160
 hetcorHT, 426
 HETERO2DJ, 406
 HMBC, 200
 hmbcHT, 430
 HMQC, 152
 HMQCTOXY, 356
 HObs_FDDec, 398

HOMO2DJ, 410
 HSQC, 144
 HSQCAD, 134
 HSQCADTOXY, 332
 hsqcHT, 434
 hsqcctocsyHT, 438
 HSQCCTOXY, 344

I

INADEQUATE, 370
 INADEQUATEAD, 374

M

Modular Experiment Setup, 20

N

NOESY, 122
 NOESY1D, 218
 noesyHT, 442

P

PHOSPHORUS, 38
 PROTON, 26
 PureShift 1D, 70

R

ROESY, 114
 ROESY1D, 224
 ROESYAD, 118
 roesyHT, 448

S

selexcit, 238
 stepNOESY1D, 242

T

T1_MEASURE, 54

Index

T2_MEASURE, 58

TOCSY, 106

TOCSY1D, 230

tocsyHT, 452

Z

zCOSY, 126

zTOCSY, 110

zTOCSY1D, 234

In this book

This guide provides more information about the small-molecule liquids experiments available in the Agilent VnmrJ 4 Experiment Selector.

© Agilent Technologies, Inc. 2013

Revision A, March 2013



G7446-90515



Agilent Technologies